

FMM5709X

K / Ka Band Low Noise Amplifier MMIC

FEATURES

- Low Noise Figure : NF = 2.5dB (Typ.) @ f=30GHz
- High Associated Gain : Gas = 23dB (Typ.) @f=30GHz
- Broad Band : 17.5 ~ 32GHz
- High Output Power : P1dB = 12.5dBm (Typ.) @f=30GHz
- Impedance Matched Zin/Zout = 50Ω

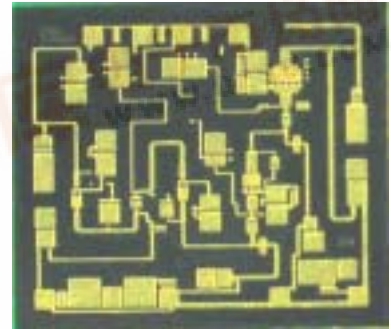

DESCRIPTION

The FMM5709X is a LNA MMIC designed for applications in the 17.5 - 32 GHz frequency range. This product is well suited for satellite communications, radio link, and applications where low noise and high dynamic range are required.

Eudyna's stringent Quality Assurance Program assures the highest reliability and consistent performance.

ABSOLUTE MAXIMUM RATING

Item	Symbol	Rating	Unit
Drain Voltage	VDD	4	V
Input Power	Pin	-3	dBm
Storage Temperature	Tstg	-65 to +175	°C

RECOMMENDED OPERATING CONDITIONS

Item	Symbol	Recommend	Unit
Drain Voltage	VDD	<=3	V
Operating Backside Temperature	Top	-45 to +85	°C

ELECTRICAL CHARACTERISTICS (Ambient Temperature Ta=25°C)

Item	Symbol	Test Conditions	Limits			Unit
			Min.	Typ.	Max.	
Noise Figure	NF	VDD=3V f=30GHz ZL=ZS=50ohm	-	2.5	3.0	dB
Associated Gain	Gas		20	23	26	dB
Output Power at 1dB G.C.P.	P1dB		-	12.5	-	dBm
Output 3rd order intercept point	OIP3		-	22.5	-	dBm
Drain Current at 1dB G.C.P.	Iddrf		-	60	75	mA
Input Return Loss	RLin		-	-10	-	dB
Output Return Loss	RLout		-	-10	-	dB

ESD	Class 0	~ 199V
-----	---------	--------

Note : Based on EIAJ ED-4701 C-111A(C=100pF, R=1.5kW)

FMM5709X

K / Ka Band Low Noise Amplifier MMIC

NOISE FIGURE, ASSOCIATED GAIN vs. FREQUENCY

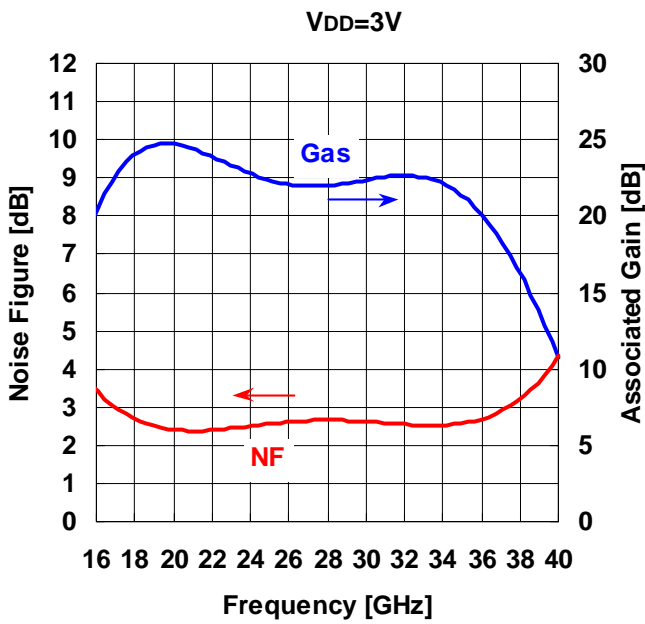

P1dB, G1dB vs. FREQUENCY

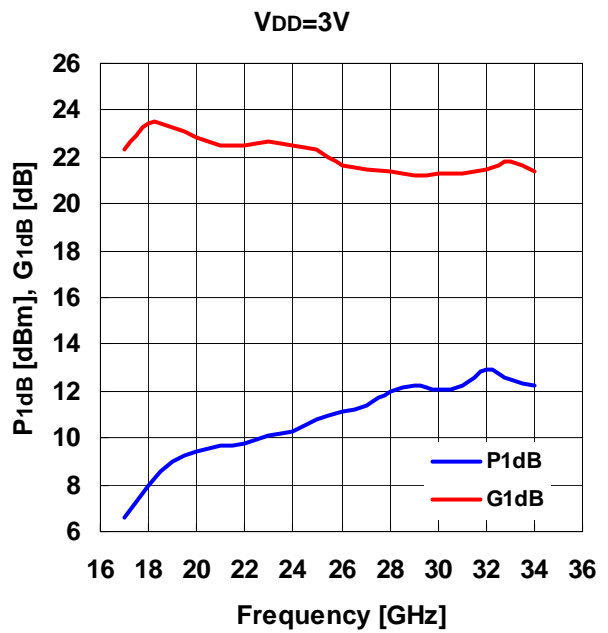

OUTPUT POWER vs. INPUT POWER

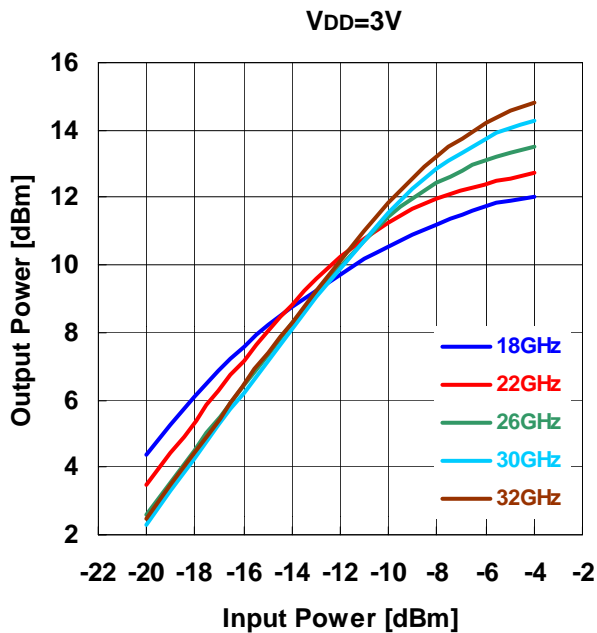

GAIN vs. INPUT POWER

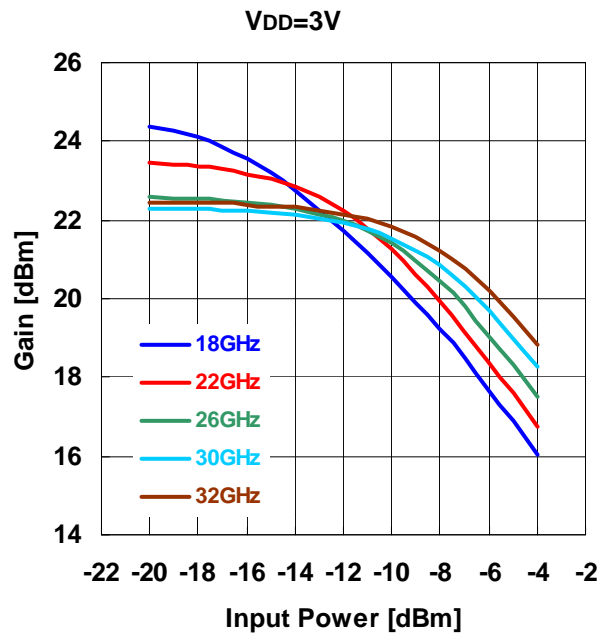

FMM5709X

K / Ka Band Low Noise Amplifier MMIC

IMD PERFORMANCE vs. TOTAL OUTPUT POWER

VDD=3V, $\Delta f=+10\text{MHz}$

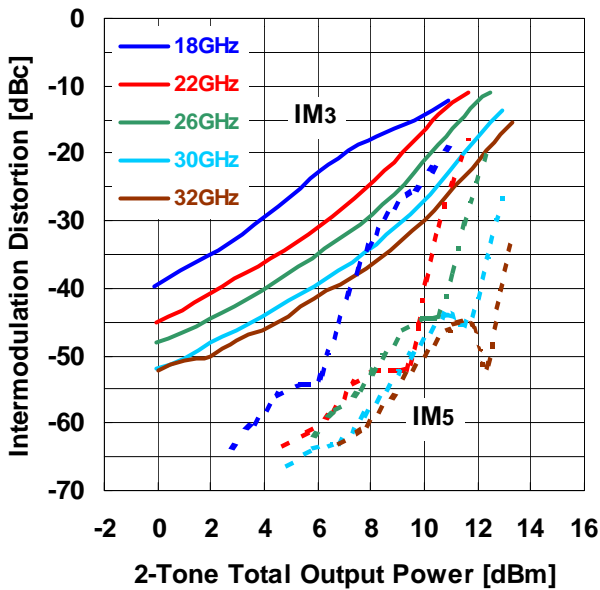

SMALL SIGNAL GAIN vs. FREQUENCY

VDD=3V

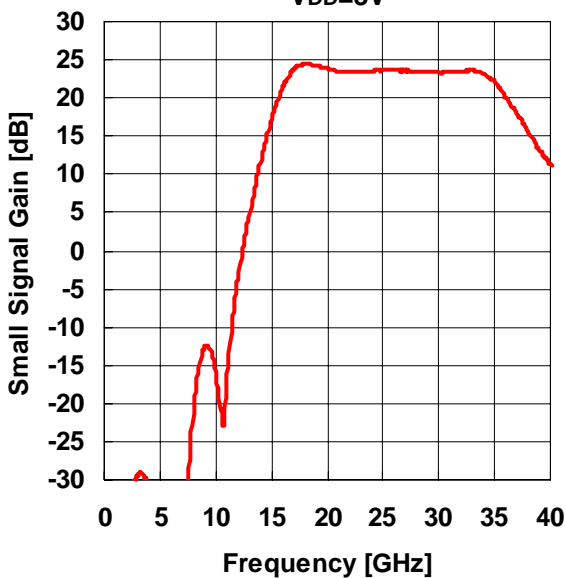

INPUT/OUTPUT RETURN LOSS vs. FREQUENCY

VDD=3V

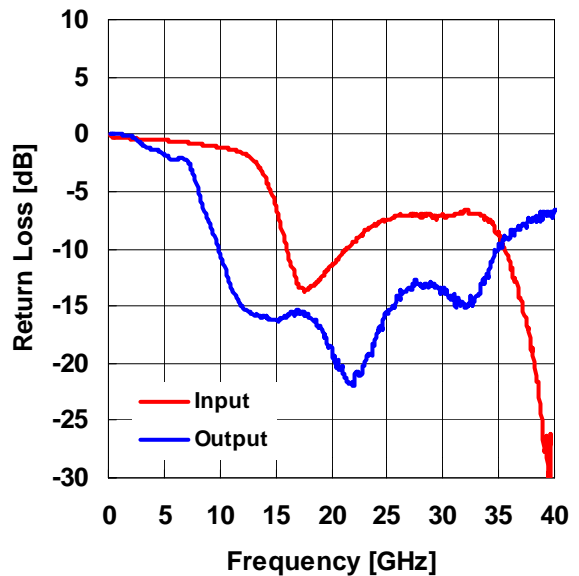

FMM5709X

K / Ka Band Low Noise Amplifier MMIC

■ S-Parameter

VDD=3V

FREQ. [MHz]	S11		S21		S12		S22	
	mag.	ang.	mag.	ang.	mag.	ang.	mag.	ang.
1000	0.959	-25.9	0.008	-156.9	0.001	-10.3	0.997	-19.1
2000	0.955	-51.0	0.019	154.9	0.001	-25.6	0.983	-39.1
3000	0.952	-75.9	0.035	65.7	0.001	-171.1	0.908	-59.1
4000	0.946	-99.9	0.031	-22.8	0.001	173.6	0.858	-75.7
5000	0.938	-123.2	0.018	-92.8	0.001	-1.3	0.816	-94.7
6000	0.930	-146.1	0.012	-102.3	0.001	-133.3	0.771	-112.0
7000	0.919	-168.5	0.009	-106.0	0.001	147.2	0.770	-137.7
8000	0.906	169.2	0.086	-80.9	0.000	131.7	0.586	-168.1
9000	0.890	146.8	0.233	175.3	0.001	161.3	0.415	176.9
10000	0.878	123.8	0.161	97.4	0.001	136.4	0.303	162.8
11000	0.860	98.9	0.138	156.8	0.001	89.5	0.217	156.2
12000	0.828	71.7	0.655	122.9	0.001	149.3	0.179	156.1
13000	0.769	40.9	1.666	71.2	0.002	13.5	0.165	154.9
14000	0.657	6.8	3.671	17.1	0.001	-15.4	0.162	149.5
15000	0.488	-27.9	7.153	-44.3	0.001	110.3	0.155	141.8
16000	0.319	-54.0	11.694	-111.8	0.002	-133.8	0.159	136.8
17000	0.222	-66.7	15.274	-179.8	0.001	-93.7	0.170	122.7
18000	0.210	-73.7	16.572	117.2	0.002	-103.6	0.158	109.1
19000	0.233	-91.4	16.251	61.8	0.002	83.2	0.146	91.6
20000	0.266	-112.2	15.490	13.4	0.003	159.7	0.115	80.0
21000	0.304	-134.9	15.034	-30.5	0.002	101.3	0.090	81.2
22000	0.342	-155.9	14.888	-71.8	0.002	122.4	0.079	90.9
23000	0.376	-177.1	14.901	-111.9	0.004	118.6	0.099	98.6
24000	0.402	162.2	15.063	-151.4	0.001	-5.9	0.130	94.2
25000	0.424	141.7	15.153	169.5	0.002	64.4	0.165	86.2
26000	0.441	123.4	15.263	130.8	0.005	43.5	0.196	69.3
27000	0.444	105.3	15.068	92.7	0.003	1.9	0.209	52.1
28000	0.437	88.5	14.910	55.4	0.004	24.1	0.222	33.2
29000	0.439	72.7	14.657	18.6	0.003	-31.2	0.221	14.3
30000	0.447	57.9	14.717	-18.1	0.003	-48.2	0.213	-1.9
31000	0.441	42.1	14.839	-54.9	0.002	6.4	0.202	-16.6
32000	0.457	25.4	14.982	-93.4	0.005	-11.1	0.179	-22.8
33000	0.453	5.3	15.122	-133.5	0.006	-132.4	0.196	-29.9
34000	0.414	-17.9	14.577	-176.8	0.008	103.9	0.238	-43.6
35000	0.365	-43.2	12.651	139.2	0.004	109.2	0.327	-69.5
36000	0.276	-67.3	10.093	97.6	0.005	161.1	0.355	-98.2
37000	0.188	-89.6	7.902	59.6	0.007	42.3	0.401	-127.4
38000	0.112	-107.1	6.067	26.8	0.006	63.4	0.416	-152.8
39000	0.053	-116.3	4.710	-3.9	0.010	23.4	0.446	179.1
40000	0.005	56.6	3.687	-31.8	0.010	16.7	0.459	160.2

FMM5709X

K / Ka Band Low Noise Amplifier MMIC

THERMAL INFORMATION (REFERENCE DATA)

	VDD=3V, IDD=60mA	Unit
ΔT_{ch}	18	$^{\circ}\text{C}$

MTTF vs T_{ch}

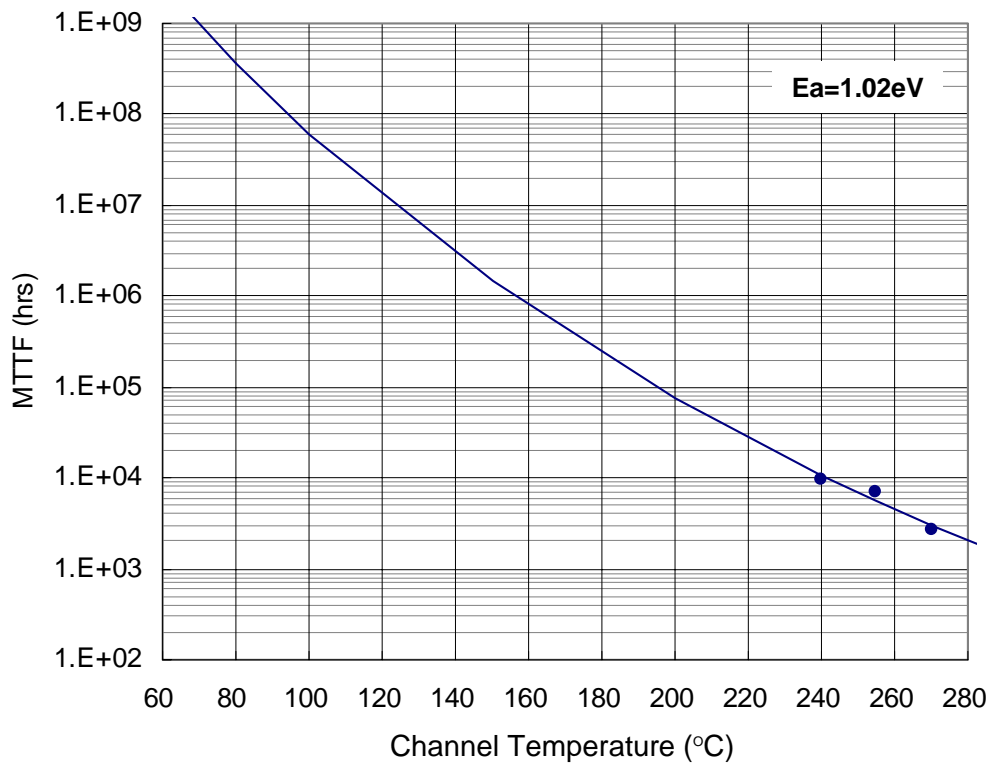

FMM5709X

K / Ka Band Low Noise Amplifier MMIC

■ Chip Outline and Bonding Pad Locations (Dimension in Micro-Meters)

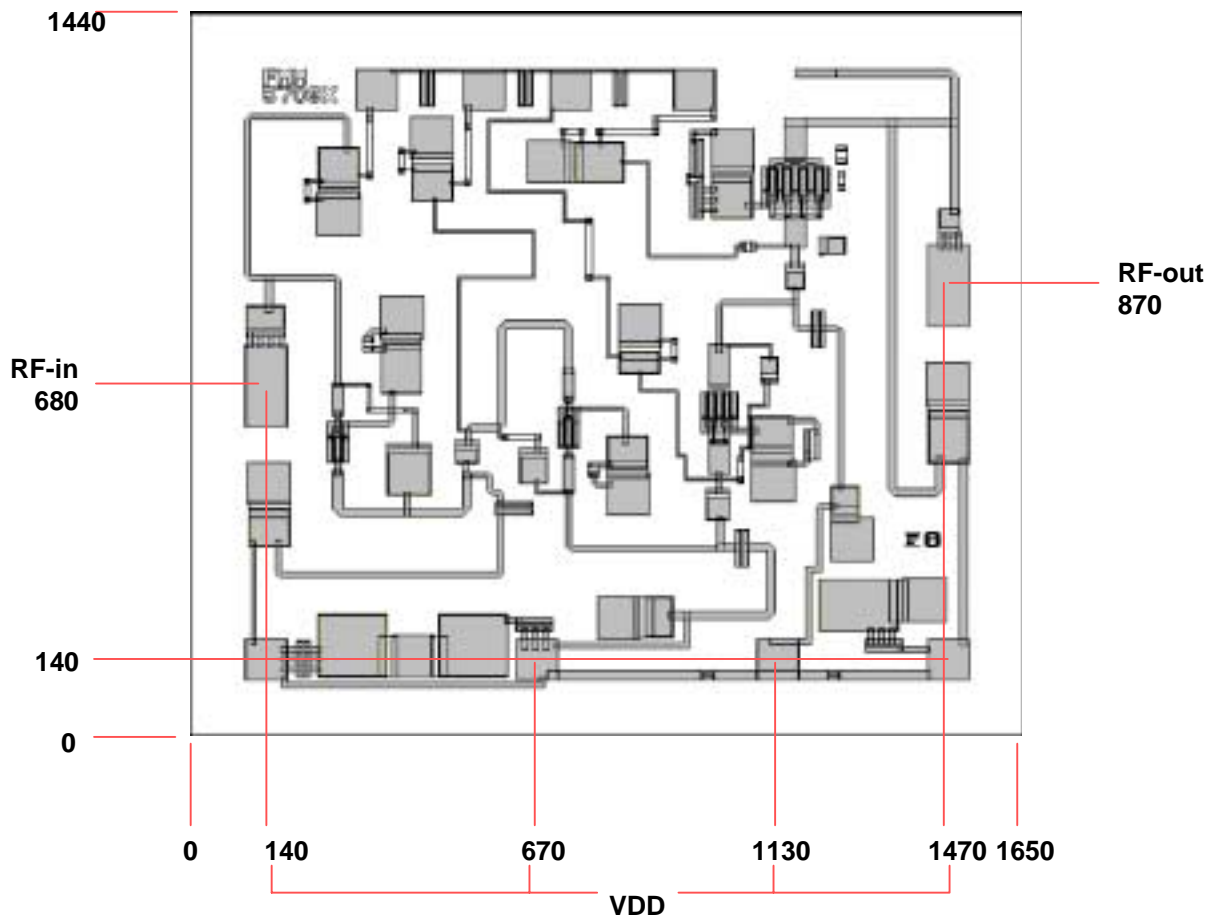

Chip Size : $1650 \pm 30 \mu\text{m} \times 1440 \pm 30 \mu\text{m}$

Chip Thickness : $85 \mu\text{m} \pm 20 \mu\text{m}$

Bonding Pad Size :

RF-Pad : $80 \mu\text{m} \times 160 \mu\text{m}$

VDD-Pad : $80 \mu\text{m} \times 80 \mu\text{m}$

FMM5709X

K / Ka Band Low Noise Amplifier MMIC

■ BONDING LAYOUT / EXTERNAL CIRCUIT

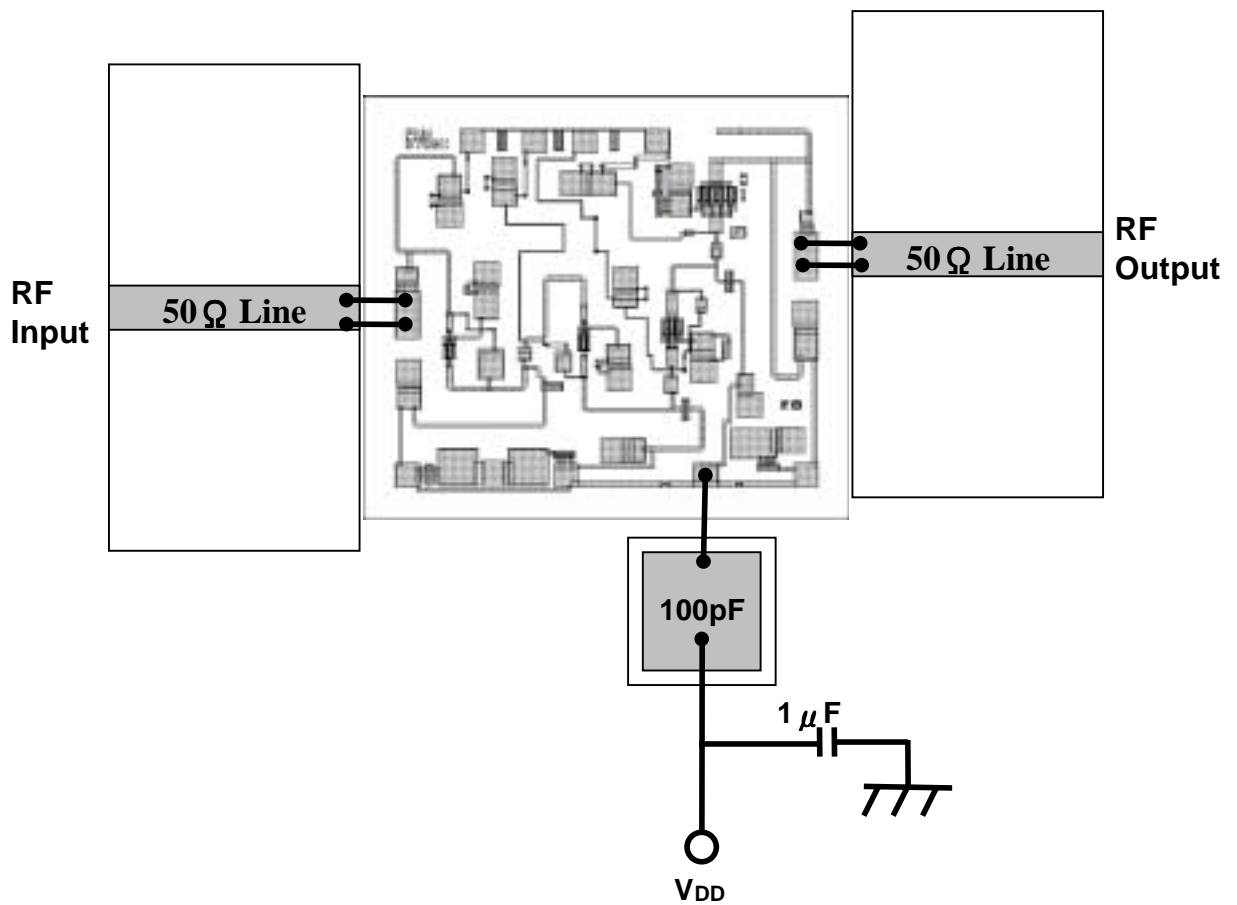

“Copper” is recommended material of the package or carrier.

FMM5709X

K / Ka Band Low Noise Amplifier MMIC

■ DIE ATTACH

- 1) The die-attach station must have accurate temperature control, and an inert forming gas should be used.
- 2) Chips should be kept at room temperature except during die-attach.
- 3) Place package or carrier on the heated stage.
- 4) Lightly grasp the chip edges by the longer side using tweezers.

Die attach conditions

Stage Temperature : 300 to 310 deg.C

Time : less than 15 seconds

AuSn Perform Volume : per next Figure

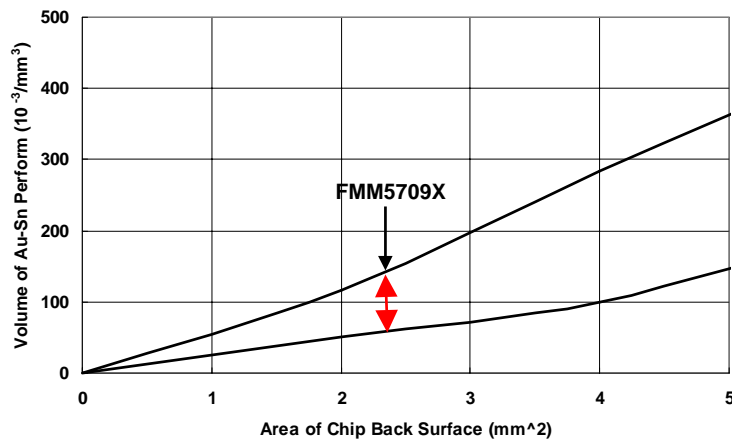

■ WIRE BONDING

The bonding equipment must be properly grounded. The following or equivalent equipment, tools, materials, and conditions are recommended.

1) Bonding Equipment and Bonding Tool.

Bonding Equipment : West Bond Model 7400 (Manual Bonder)

Bonding Tool : CCOD-1/16-S-437-60-F-2010-MP (Deweyl)

2) Bonding Wire

Material : Hard or Half hard gold

Diameter : 0.7 to 1.0 mil

3) Bonding Conditions

Method : Thermal Compression Bonding with Ultrasonic Power

Tool Force : 0.196 N +/- 0.0196 N

Stage Temperature : 215 deg.C +/- 5 deg.C

Tool Heater : None

Ultrasonic Power Transmitter : West Bond Model 1400

Duration : 150 mS/Bond

FMM5709X

K / Ka Band Low Noise Amplifier MMIC

Eudyna Devices USA Inc.

2355 Zanker Rd.
San Jose, CA 95131-1138, U.S.A.
TEL: (408) 232-9500
FAX: (408) 428-9111
www.us.eudyna.com

Eudyna Devices Europe Ltd.

Network House
Norreys Drive
Maidenhead, Berkshire SL6 4FJ
United Kingdom
TEL: +44 (0) 1628 504800
FAX: +44 (0) 1628 504888

Eudyna Devices Asia Pte. Ltd.

Hong Kong Branch
Rm.1101, Ocean Centre, 5 Canton Road
Tsim Sha Tsui, Kowloon, Hong Kong
TEL: +852-2377-0227
FAX: +852-2377-3921

Eudyna Devices Inc.

Sales Division
1, Kanai-cho, Sakae-ku
Yokohama, 244-0845, Japan
TEL +81-45-853-8156
FAX +81-45-853-8170

CAUTION

Eudyna Devices Inc. products contain **gallium arsenide (GaAs)** which can be hazardous to the human body and the environment. For safety, observe the following procedures:

- Do not put these products into the mouth.
- Do not alter the form of this product into a gas, powder, or liquid through burning, crushing, or chemical processing as these by-products are dangerous to the human body if inhaled, ingested, or swallowed.
- Observe government laws and company regulations when discarding this product. This product must be discarded in accordance with methods specified by applicable hazardous waste procedures.

Eudyna Devices Inc. reserves the right to change products and specifications without notice. The information does not convey any license under rights of Eudyna Devices Inc. or others.

© 2004 Eudyna Devices USA Inc.
Printed in U.S.A.

