

Technische Information / technical information

eupec

IGBT-Module
IGBT-Modules

FS15R06XL4



vorläufige Daten
preliminary data

Höchstzulässige Werte / maximum rated values

Elektrische Eigenschaften / electrical properties

Kollektor Emitter Sperrspannung collector emitter voltage	$T_{vj} = 25\text{ °C}$	V_{CES}	600	V
Kollektor Dauergleichstrom DC collector current	$T_C = 75\text{ °C}$	$I_{C,nom.}$	15	A
	$T_C = 25\text{ °C}$	I_C	20	A
Periodischer Kollektor Spitzenstrom repetitive peak collector current	$t_p = 1\text{ms}, T_C = 75\text{ °C}$	I_{CRM}	30	A
Gesamt Verlustleistung total power dissipation	$T_c = 25\text{ °C}, \text{ Transistor}$	P_{tot}	81	W
Gate Emitter Spitzenspannung gate emitter peak voltage		V_{GES}	± 20	V
Dauergleichstrom DC forward current		I_F	15	A
Periodischer Spitzenstrom repetitive peak forward current	$t_p = 1\text{ms}$	I_{FRM}	30	A
Grenzlastintegral I^2t value	$V_R = 0\text{V}, t_p = 10\text{ms}, T_{vj} = 125\text{ °C}$	I^2t	34	A ² s
Isolations Prüfspannung insulation test voltage	RMS, $f = 50\text{Hz}, t = 1\text{min}$	V_{ISOL}	2,5	kV

Charakteristische Werte / characteristic values

Transistor Wechselrichter / transistor inverter

			min.	typ.	max.	
Kollektor Emitter Sättigungsspannung collector emitter saturation voltage	$V_{GE} = 15\text{V}, T_{vj} = 25\text{ °C}, I_C = I_{C,nom.}$	V_{CESat}	-	1,95	2,55	V
	$V_{GE} = 15\text{V}, T_{vj} = 125\text{ °C}, I_C = I_{C,nom.}$		-	2,20	-	V
Gate Schwellenspannung gate threshold voltage	$V_{CE} = V_{GE}, T_{vj} = 25\text{ °C}, I_C = 0,4\text{ mA}$	$V_{GE(th)}$	4,5	5,5	6,5	V
Gateladung gate charge	$V_{GE} = -15\text{V} \dots +15\text{V}$	Q_G	-	0,08	-	μC
Eingangskapazität input capacitance	$f = 1\text{MHz}, T_{vj} = 25\text{ °C}, V_{CE} = 25\text{V}, V_{GE} = 0\text{V}$	C_{ies}	-	0,675	-	nF
Rückwirkungskapazität reverse transfer capacitance	$f = 1\text{MHz}, T_{vj} = 25\text{ °C}, V_{CE} = 25\text{V}, V_{GE} = 0\text{V}$	C_{res}	-	0,06	-	nF
Kollektor Emitter Reststrom collector emitter cut off current	$V_{CE} = 600\text{ V}, V_{GE} = 0\text{V}, T_{vj} = 25\text{ °C}$	I_{CES}	-	-	5	mA
Gate Emitter Reststrom gate emitter leakage current	$V_{CE} = 0\text{V}, V_{GE} = 20\text{V}, T_{vj} = 25\text{ °C}$	I_{GES}	-	-	400	nA

prepared by: P. Kanschat	date of publication: 2002-12-17
approved: M. Hierholzer	revision: 2.0



Technische Information / technical information

eupec

IGBT-Module
IGBT-Modules

FS15R06XL4



vorläufige Daten
preliminary data

Charakteristische Werte / characteristic values

Transistor Wechselrichter / transistor inverter

			min.	typ.	max.	
Einschaltverzögerungszeit (induktive Last) turn on delay time (inductive load)	$I_C = 15 \text{ A}, V_{CC} = 300 \text{ V}$	$t_{d,on}$	-	20	-	ns
	$V_{GE} = \pm 15 \text{ V}, R_G = 18 \ \Omega, T_{vj} = 25^\circ \text{C}$					
	$V_{GE} = \pm 15 \text{ V}, R_G = 18 \ \Omega, T_{vj} = 125^\circ \text{C}$					
Anstiegszeit (induktive Last) rise time (inductive load)	$I_C = 15 \text{ A}, V_{CC} = 300 \text{ V}$	t_r	-	7	-	ns
	$V_{GE} = \pm 15 \text{ V}, R_G = 18 \ \Omega, T_{vj} = 25^\circ \text{C}$					
	$V_{GE} = \pm 15 \text{ V}, R_G = 18 \ \Omega, T_{vj} = 125^\circ \text{C}$					
Abschaltverzögerungszeit (induktive Last) turn off delay time (inductive load)	$I_C = 15 \text{ A}, V_{CC} = 300 \text{ V}$	$t_{d,off}$	-	80	-	ns
	$V_{GE} = \pm 15 \text{ V}, R_G = 18 \ \Omega, T_{vj} = 25^\circ \text{C}$					
	$V_{GE} = \pm 15 \text{ V}, R_G = 18 \ \Omega, T_{vj} = 125^\circ \text{C}$					
Fallzeit (induktive Last) fall time (inductive load)	$I_C = 15 \text{ A}, V_{CC} = 300 \text{ V}$	t_f	-	18	-	ns
	$V_{GE} = \pm 15 \text{ V}, R_G = 18 \ \Omega, T_{vj} = 25^\circ \text{C}$					
	$V_{GE} = \pm 15 \text{ V}, R_G = 18 \ \Omega, T_{vj} = 125^\circ \text{C}$					
Einschaltverlustenergie pro Puls turn on energy loss per pulse	$I_C = 15 \text{ A}, V_{CC} = 300 \text{ V}$ $R_G = 18 \ \Omega, T_{vj} = 125^\circ \text{C}, L_\sigma = 15 \text{ nH}$	E_{on}	-	0,45	-	mJ
Ausschaltverlustenergie pro Puls turn off energy loss per pulse	$I_C = 15 \text{ A}, V_{CC} = 300 \text{ V}$ $R_G = 18 \ \Omega, T_{vj} = 125^\circ \text{C}, L_\sigma = 15 \text{ nH}$	E_{off}	-	0,30	-	mJ
Kurzschlussverhalten SC data	$t_p \leq 10 \mu\text{sec}, V_{GE} \leq 15 \text{ V}, T_{vj} = 125^\circ \text{C},$ $V_{CC} = 360 \text{ V}, V_{CEmax} = V_{CES} - L_{\sigma CE} \cdot di/dt $	I_{SC}	-	68	-	A
Modulinduktivität stray inductance module		$L_{\sigma CE}$	-	25	-	nH
Leitungswiderstand, Anschluss-Chip lead resistance, terminal-chip	$T_c = 25^\circ \text{C}$	$R_{CC/EE}$	-	8	-	m Ω

Charakteristische Werte / characteristic values

Diode Wechselrichter / diode inverter

Durchlassspannung forward voltage	$I_F = 15 \text{ A}, V_{GE} = 0 \text{ V}, T_{vj} = 25^\circ \text{C}$	V_F	-	1,4	2	V
	$I_F = 15 \text{ A}, V_{GE} = 0 \text{ V}, T_{vj} = 125^\circ \text{C}$					
Rückstromspitze peak reverse recovery current	$I_F = 15 \text{ A}, -di_F/dt = 2000 \text{ A}/\mu\text{s}$	I_{RM}	-	36	-	A
	$V_R = 300 \text{ V}, V_{GE} = -10 \text{ V}, T_{vj} = 25^\circ \text{C}$					
	$V_R = 300 \text{ V}, V_{GE} = -10 \text{ V}, T_{vj} = 125^\circ \text{C}$					
Sperrverzögerungsladung recovered charge	$I_F = 15 \text{ A}, -di_F/dt = 2000 \text{ A}/\mu\text{s}$	Q_r	-	0,9	-	μC
	$V_R = 300 \text{ V}, V_{GE} = -10 \text{ V}, T_{vj} = 25^\circ \text{C}$					
	$V_R = 300 \text{ V}, V_{GE} = -10 \text{ V}, T_{vj} = 125^\circ \text{C}$					
Ausschaltenergie pro Puls reverse recovery energy	$I_F = 15 \text{ A}, -di_F/dt = 2000 \text{ A}/\mu\text{s}$	E_{rec}	-	0,25	-	mJ
	$V_R = 300 \text{ V}, V_{GE} = -10 \text{ V}, T_{vj} = 25^\circ \text{C}$					
	$V_R = 300 \text{ V}, V_{GE} = -10 \text{ V}, T_{vj} = 125^\circ \text{C}$					

Technische Information / technical information

eupec

IGBT-Module
IGBT-Modules

FS15R06XL4



vorläufige Daten
preliminary data

Charakteristische Werte / characteristic values

NTC-Widerstand / NTC-thermistor

			min.	typ.	max.	
Nennwiderstand rated resistance	$T_c = 25^\circ\text{C}$	R_{25}	-	5	-	k Ω
Abweichung von R_{100} deviation of R_{100}	$T_c = 100^\circ\text{C}$, $R_{100} = 493\Omega$	$\Delta R/R$	-5	-	5	%
Verlustleistung power dissipation	$T_c = 25^\circ\text{C}$	P_{25}	-	-	20	mW
B-Wert B-value	$R_2 = R_1 \exp[B(1/T_2 - 1/T_1)]$	$B_{25/50}$	-	3375	-	K

Thermische Eigenschaften / thermal properties

Innerer Wärmewiderstand; DC thermal resistance, junction to case; DC	Transistor Wechselr. / transistor inverter	R_{thJC}	-	-	1,55	K/W
	Diode Wechselrichter / diode inverter		-	-	2,70	K/W
Wärmewiderstand; DC thermal resistance, junction to heatsink; DC	Transistor Wechselr. / transistor inverter	R_{thJH}	-	1,90	-	K/W
	Diode Wechselrichter / diode inverter		-	3,20	-	K/W
	$\lambda_{\text{Paste}} = 1 \text{ W/m}^2\text{K}$ / $\lambda_{\text{grease}} = 1 \text{ W/m}^2\text{K}$					
Übergangs-Wärmewiderstand, DC thermal resistance, case to heatsink, DC	Transistor Wechselr. / transistor inverter	R_{thCH}	-	0,65	-	K/W
	Diode Wechselrichter / diode inverter		-	0,85	-	K/W
	$\lambda_{\text{Paste}} = 1 \text{ W/m}^2\text{K}$ / $\lambda_{\text{grease}} = 1 \text{ W/m}^2\text{K}$					
Höchstzulässige Sperrschichttemp. maximum junction temperature		T_{vjmax}	-	-	150	$^\circ\text{C}$
Betriebstemperatur operation temperature		T_{op}	-40	-	125	$^\circ\text{C}$
Lagertemperatur storage temperature		T_{stg}	-40	-	125	$^\circ\text{C}$

Mechanische Eigenschaften / mechanical properties

Innere Isolation internal insulation				Al_2O_3	
CTI comperative tracking index				225	
Anpresskraft pro Feder mounting force per clamp		F		20..50	N
Gewicht weight		G		25	g
Kriechstrecke creepage distance	Anschluss - Kühlkörper terminal to heatsink			10,5	mm
	Anschluss - Anschluss terminal to terminal			5	mm
Luftstrecke clearance distance	Anschluss - Kühlkörper terminal to heatsink			9	mm
	Anschluss - Anschluss terminal to terminal			5	mm



vorläufige Daten
preliminary data

Ausgangskennlinie (typisch)
output characteristic (typical)

$I_C = f(V_{CE})$
 $V_{GE} = 15V$

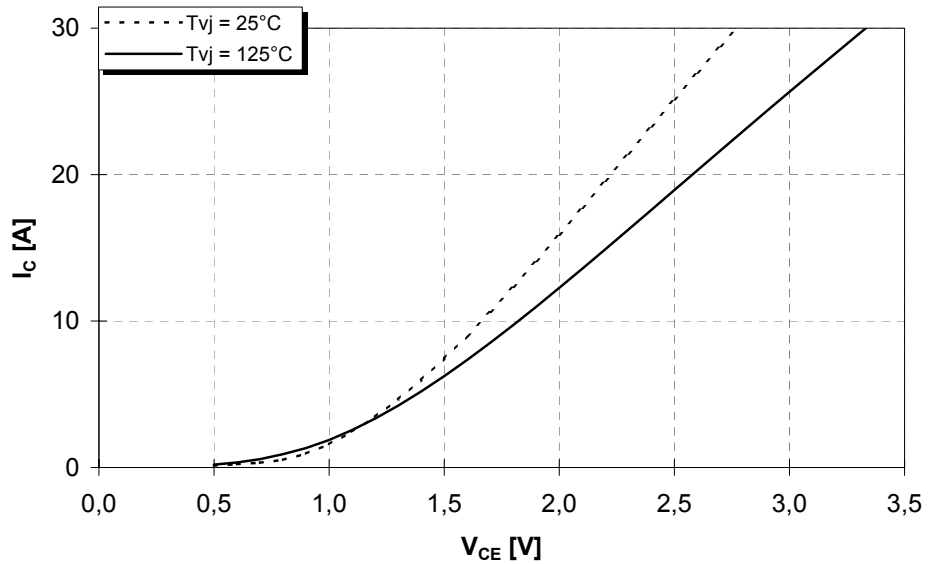

Ausgangskennlinienfeld (typisch)
output characteristic (typical)

$I_C = f(V_{CE})$
 $T_{vj} = 125^\circ C$

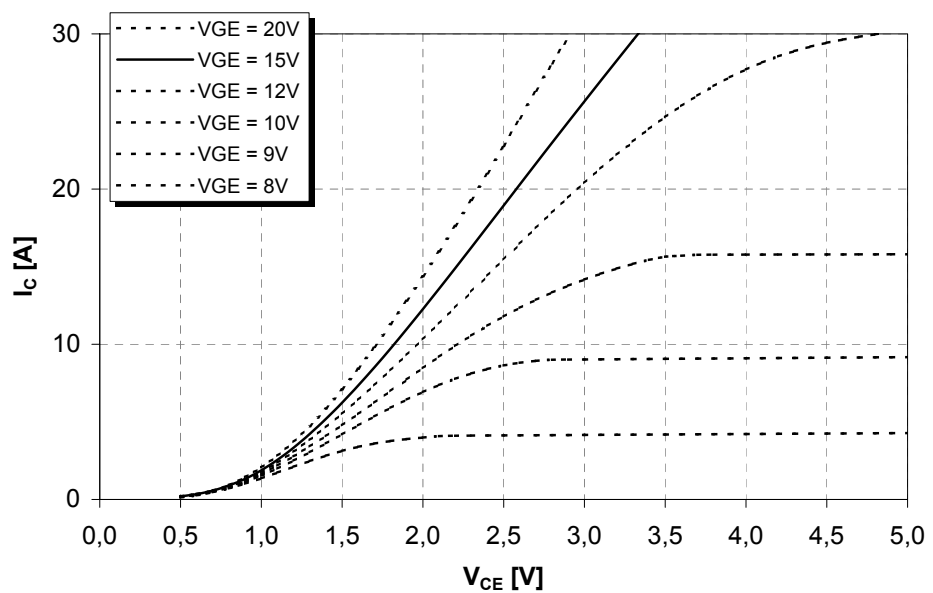



vorläufige Daten
preliminary data

Übertragungscharakteristik (typisch)
transfer characteristic (typical)

$I_C = f(V_{GE})$
 $V_{CE} = 20V$

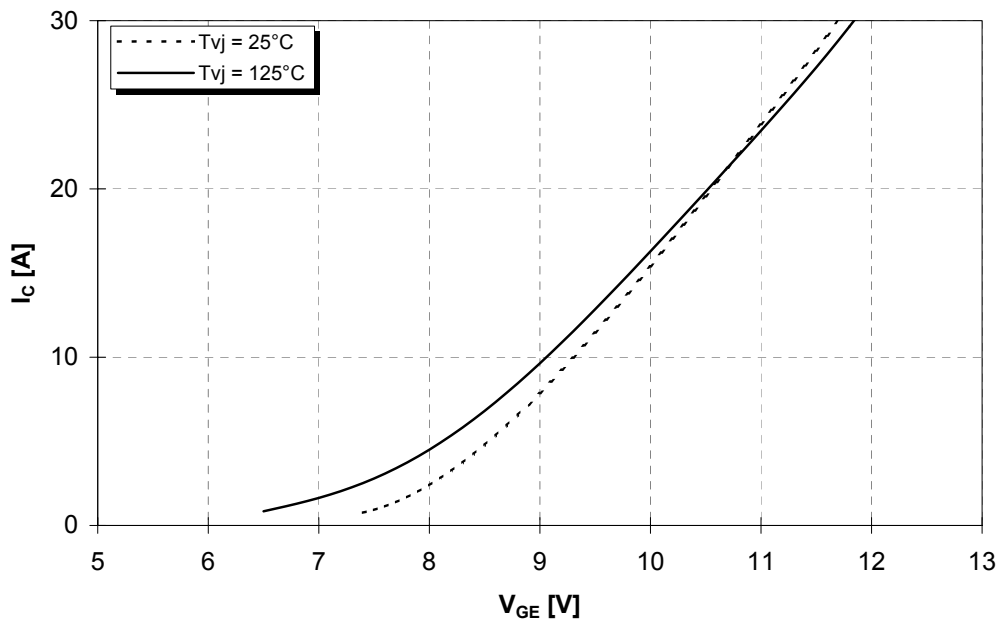

Durchlasskennlinie der Inversdiode (typisch)
forward characteristic of inverse diode (typical)

$I_F = f(V_F)$

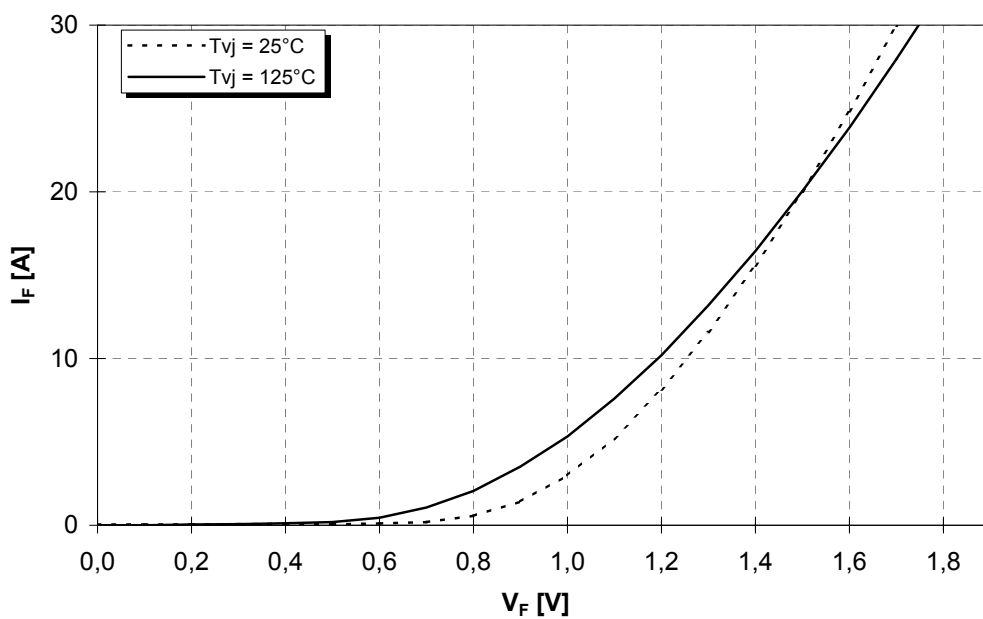



vorläufige Daten
preliminary data

Schaltverluste (typisch)
switching losses (typical)

$E_{on} = f(I_C), E_{off} = f(I_C), E_{rec} = f(I_C)$
 $V_{GE} = \pm 15V, R_{Gon} = R_{Goff} = 18\Omega, V_{CE} = 300V, T_{vj} = 125^\circ C$

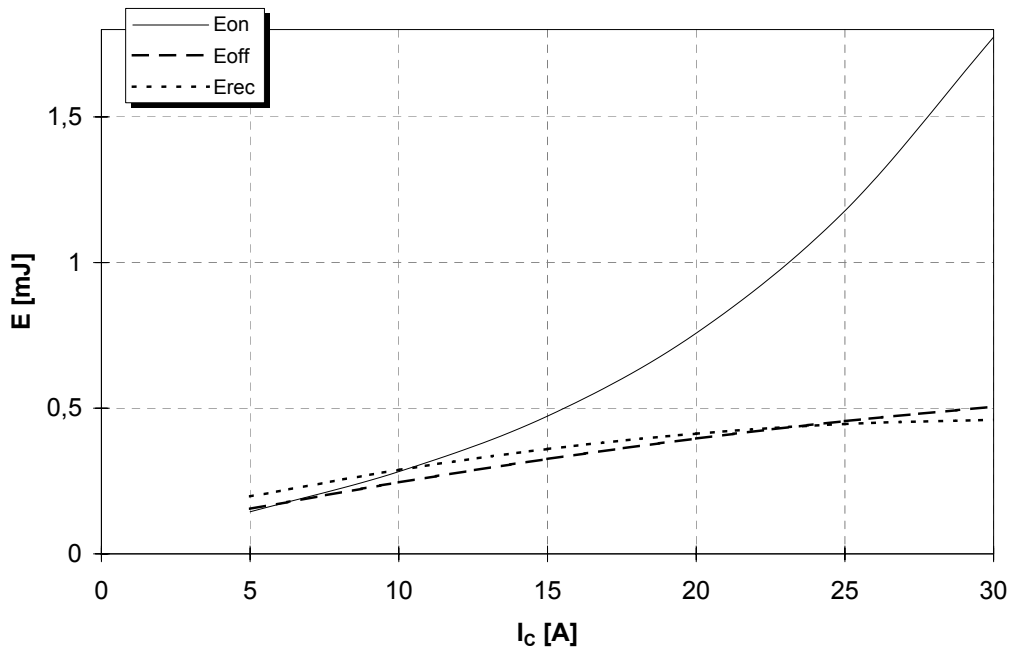

Schaltverluste (typisch)
switching losses (typical)

$E_{on} = f(R_G), E_{off} = f(R_G), E_{rec} = f(R_G)$
 $V_{GE} = \pm 15V, I_C = 15A, V_{CE} = 300V, T_{vj} = 125^\circ C$

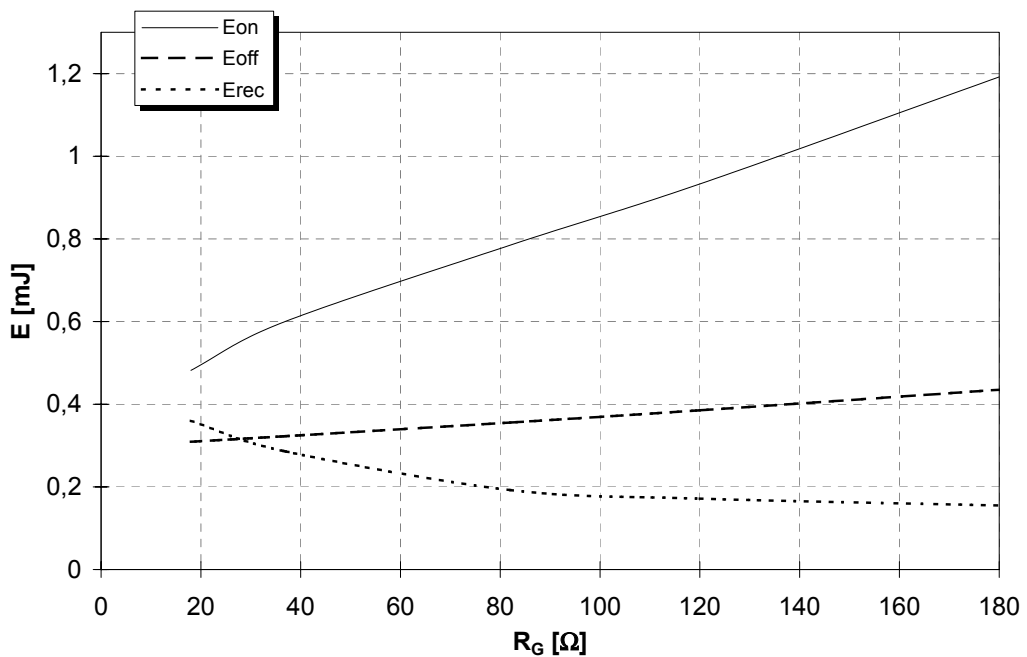



vorläufige Daten
preliminary data

**Transienter Wärmewiderstand
transient thermal impedance**

$Z_{thJH} = f(t)$

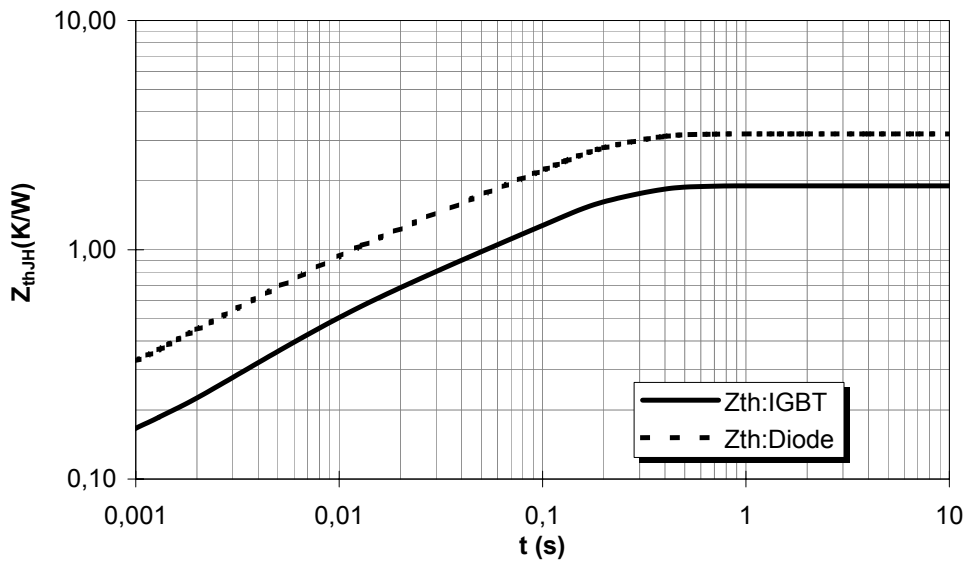

i	1	2	3	4
r_i [K/kW]: IGBT	114,0	380,0	1064,0	342,0
τ_i [s]: IGBT	0,000379	0,00745	0,11319	0,16026
r_i [K/kW]: Diode	192,0	640,0	1792,0	576,0
τ_i [s]: Diode	0,00031	0,00484	0,10644	0,14203

**Sicherer Arbeitsbereich (RBSOA)
reverse bias safe operation area (RBSOA)**

$V_{GE}=15V, T_j=125^\circ C, R_G = 18 \Omega$

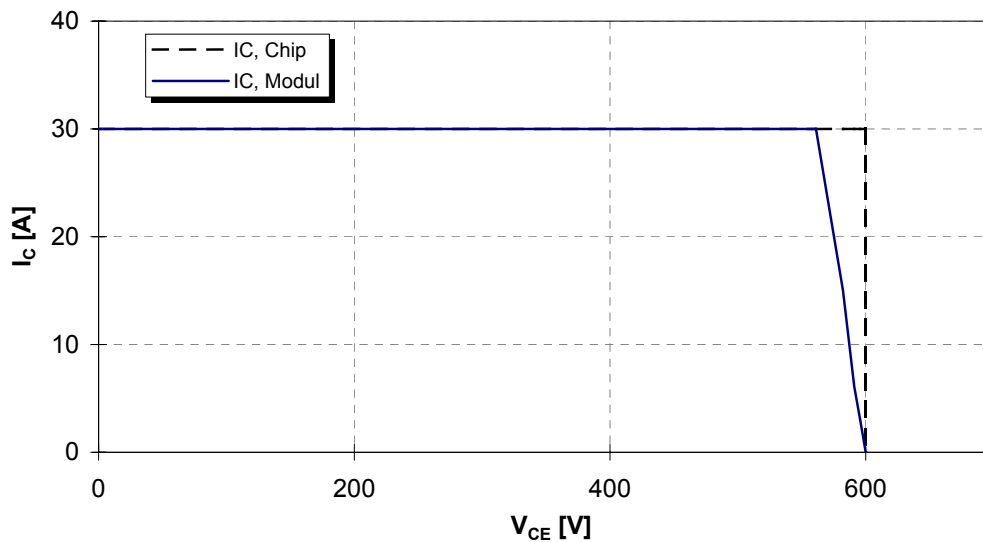



vorläufige Daten
preliminary data

Schaltbild circuit diagram

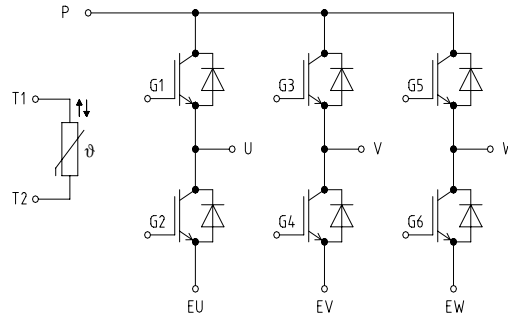

Gehäusemaße package outline

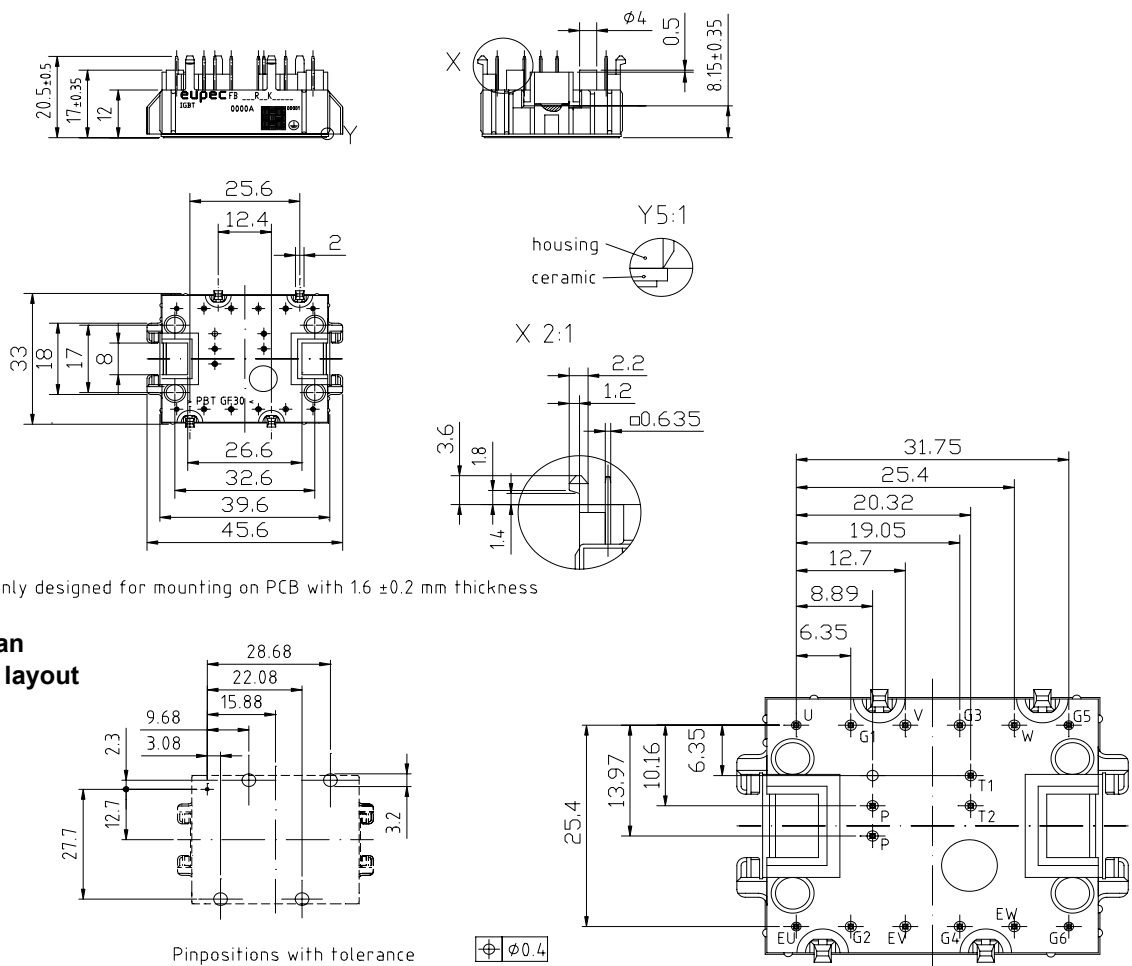

Module only designed for mounting on PCB with 1.6 ± 0.2 mm thickness

Bohrplan drilling layout

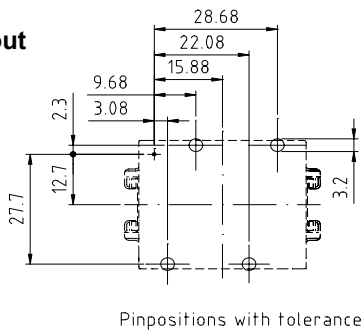

Mit dieser technischen Information werden Halbleiterbauelemente spezifiziert, jedoch keine Eigenschaften zugesichert. Sie gilt in Verbindung mit den zugehörigen technischen Erläuterungen.

This technical information specifies semiconductor devices but promises no characteristics. It is valid with the belonging technical notes.

Terms & Conditions of Usage

Attention

The present product data is exclusively subscribed to technically experienced staff. This Data Sheet is describing the specification of the products for which a warranty is granted exclusively pursuant the terms and conditions of the supply agreement. There will be no guarantee of any kind for the product and its specifications. Changes to the Data Sheet are reserved.

You and your technical departments will have to evaluate the suitability of the product for the intended application and the completeness of the product data with respect to such application. Should you require product information in excess of the data given in the Data Sheet, please contact your local Sales Office via "www.eupec.com / sales & contact".

Warning

Due to technical requirements the products may contain dangerous substances. For information on the types in question please contact your local Sales Office via "www.eupec.com / sales & contact".