

GTM CORPORATION

ISSUED DATE :2005/08/31
REVISED DATE :2005/11/28B

GJ3669 NPN EPITAXIAL PLANAR TRANSISTOR

Description

The GJ3669 is designed for using in power amplifier applications, power switching applications.

Package Dimensions

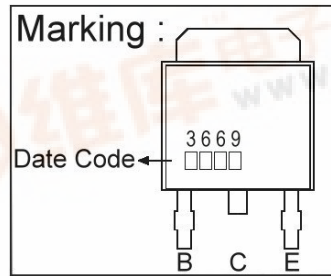
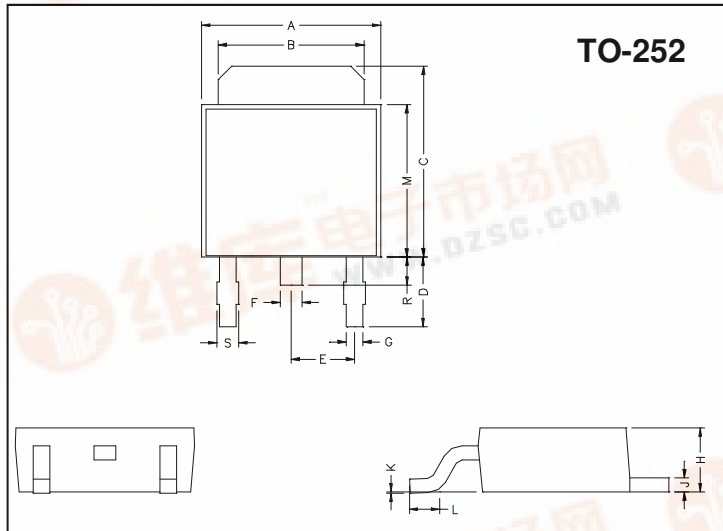

REF.	Millimeter		REF.	Millimeter	
	Min.	Max.		Min.	Max.
A	6.40	6.80	G	0.50	0.70
B	5.20	5.50	H	2.20	2.40
C	6.80	7.20	J	0.45	0.55
D	2.40	3.00	K	0	0.15
E	2.30 REF.		L	0.90	1.50
F	0.70	0.90	M	5.40	5.80
S	0.60	0.90	R	0.80	1.20

Absolute Maximum Ratings (TA=25°C)

Parameter	Symbol	Ratings	Unit
Collector to Base Voltage	V _{CB0}	80	V
Collector to Emitter Voltage	V _{CEO}	80	V
Emitter to Base Voltage	V _{EB0}	5	V
Collector Current (DC)	I _C	2	A
Total Device Dissipation (TA=25°C)	P _D	1.25	W
Junction Temperature	T _J	150	°C
Storage Temperature	T _{stg}	-55 ~ +150	°C

Electrical Characteristics (TA = 25°C unless otherwise noted)

Symbol	Min.	Typ.	Max.	Unit	Test Conditions
BV _{CB0}	80	-	-	V	I _C =100uA, I _E =0
BV _{CEO}	80	-	-	V	I _C =10mA, I _B =0
BV _{EB0}	5	-	-	V	I _E =100uA, I _C =0
I _{CB0}	-	-	1	uA	V _{CB} =80V, I _E =0
I _{EB0}	-	-	1	uA	V _{EB} =5V, I _C =0
*V _{CE(sat)}	-	0.15	0.5	V	I _C =1A, I _B =50mA
*V _{BE(sat)}	-	0.9	1.2	V	I _C =1A, I _B =50mA
*h _{FE1}	70	-	240		V _{CE} =2V, I _C =0.5A
*h _{FE2}	40	-	-		V _{CE} =2V, I _C =1.5A
f _T	-	100	-	MHz	V _{CE} =2V, I _E =500mA, f=100MHz
C _{ob}	-	30	-	pF	V _{CB} =10V, I _E =0, f=1MHz
t _{on} (Turn-On Time)	-	0.2	-	us	V _{CC} =30V, R _L =30Ω, I _C =1A,
t _{stg} (Storage Time)	-	1.0	-	us	I _{B1} =-I _{B2} =50mA,
t _f (Fall Time)	-	0.2	-	us	Duty Cycle ≤ 1%

*Pulse Test: Pulse Width ≤ 380μs, Duty Cycle ≤ 2%

Classification Of hFE1

Rank Range	O	Y
	70 ~ 140	120 ~ 240



Characteristics Curve

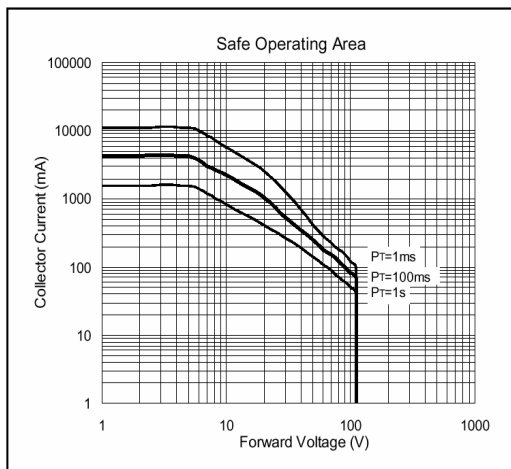
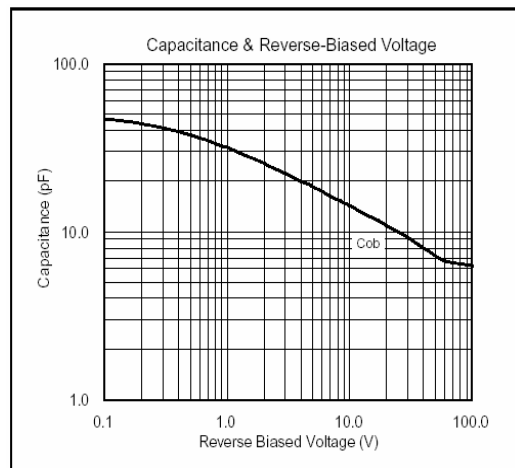
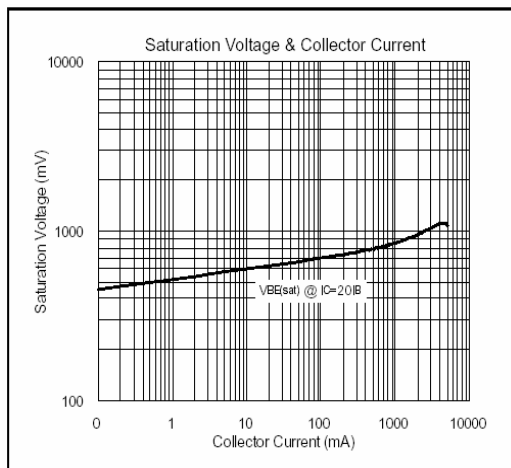
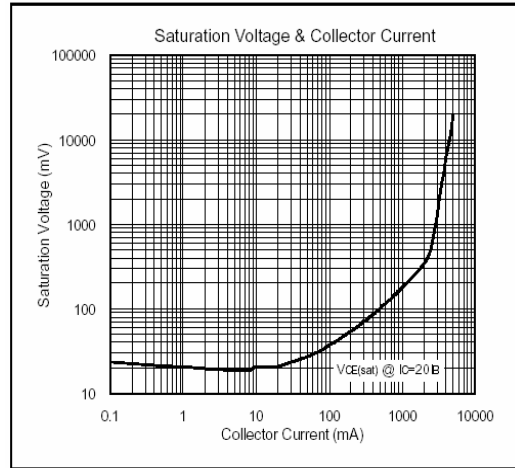
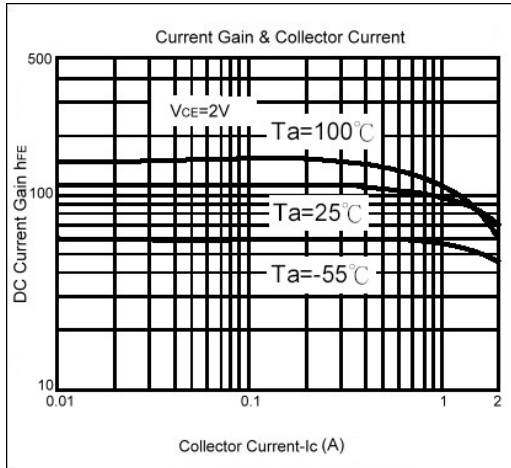

Important Notice:

- All rights are reserved. Reproduction in whole or in part is prohibited without the prior written approval of GTM.
- GTM reserves the right to make changes to its products without notice.
- GTM semiconductor products are not warranted to be suitable for use in life-support Applications, or systems.
- GTM assumes no liability for any consequence of customer product design, infringement of patents, or application assistance.

Head Office And Factory:

- Taiwan: No. 17-1 Tatung Rd. Fu Kou Hsin-Chu Industrial Park, Hsin-Chu, Taiwan, R. O. C.
- TEL : 886-3-597-7061 FAX : 886-3-597-9220, 597-0785
- China: (201203) No.255, Jang-Jiang Tsai-Lueng RD., Pu-Dung-Hsin District, Shang-Hai City, China
- TEL : 86-21-5895-7671 ~ 4 FAX : 86-21-38950165