

# GTM CORPORATION

ISSUED DATE :2003/11/27  
REVISED DATE :2004/11/29B

## GMPSA92 PNP PITAXIAL PLANAR TRANSISTOR

### Description

The GMPSA92 is designed for applications as a video output to drive color CRT, or as a dialer circuit in electronics telephone.

### Package Dimensions

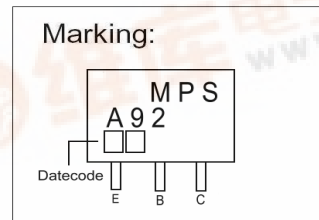
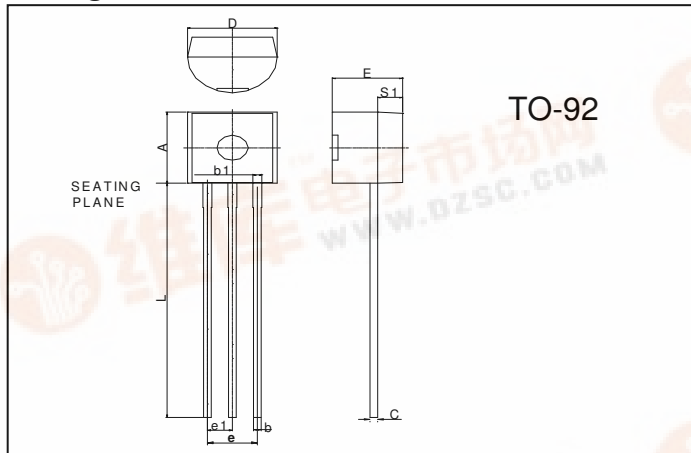

REF.	Millimeter		REF.	Millimeter	
	Min.	Max.		Min.	Max.
A	4.45	4.7	D	4.44	4.7
S1	1.02	-	E	3.30	3.81
b	0.36	0.51	L	12.70	-
b1	0.36	0.76	e1	1.150	1.390
C	0.36	0.51	e	2.42	2.66

### Absolute Maximum Ratings (Ta = 25°C, unless otherwise specified)

Parameter		Ratings	Unit
Collector to Base Voltage	VCBO	-300	V
Collector to Emitter Voltage	VCEO	-300	V
Emitter to Base Voltage	VEBO	-5	V
Collect Current(DC)	IC	-500	mA
Junction Temperature	Tj	+150	°C
Storage Temperature Range	TSTG	-55 ~ +150	°C
Total Power Dissipation	PD	625	mW

### Electrical Characteristics (Ta = 25°C, unless otherwise specified)

Symbol	Min.	Typ.	Max.	Unit	Test Conditions
BVCBO	-300	-	-	V	IC=-100uA, IE=0
BVCEO	-300	-	-	V	IC=-1mA, IB=0
BVEBO	-5	-	-	V	IE=-100uA, IC=0
ICBO	-	-	-250	nA	VCB=-200V
IEBO	-	-	-100	nA	VEB=-3V
VCE(sat)	-	-	-500	mV	IC=-20mA, IB=-2mA
VBE(sat)	-	-	-900	mV	IC=-20mA, IB=-2mA
hFE1	25	-	-	-	VCE=-10V, IC=-1mA
hFE2	40	-	-	-	VCE=-10V, IC=-10mA
hFE3	40	-	-	-	VCE=-10V, IC=-30mA
HFE4	-	100	-	-	VCE=-10V, IC=-80mA
fT	50	-	-	MHz	VCB=-20V, IC=-10mA, f=100MHz
Cob	-	-	6	pF	VCB=-20V, f=1MHz, IE=0

### Classification of Rank

Rank	hFE1	hFE2	hFE3	hFE4	VCE(sat)
NS	>60	>80	>80	>80	<200mV
N	>25	>40	>40	-	<350mV

## Characteristics Curve

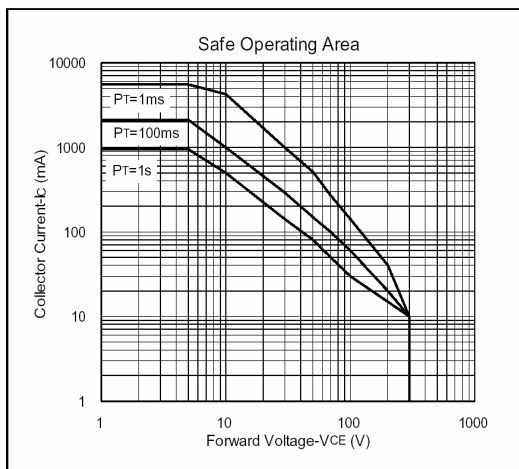
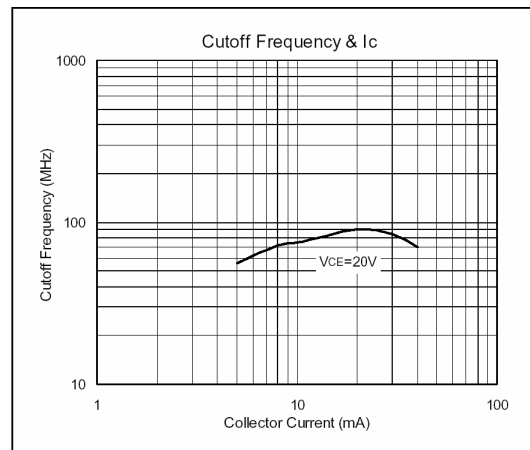
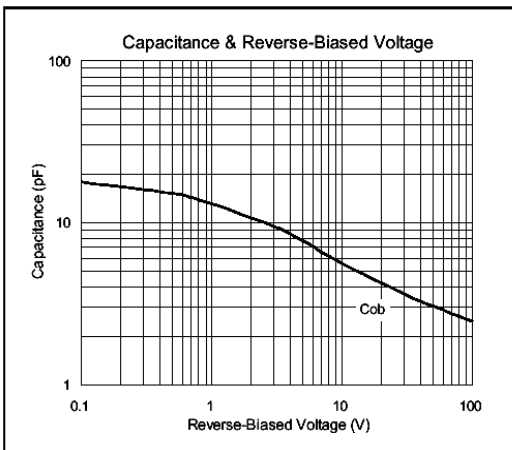
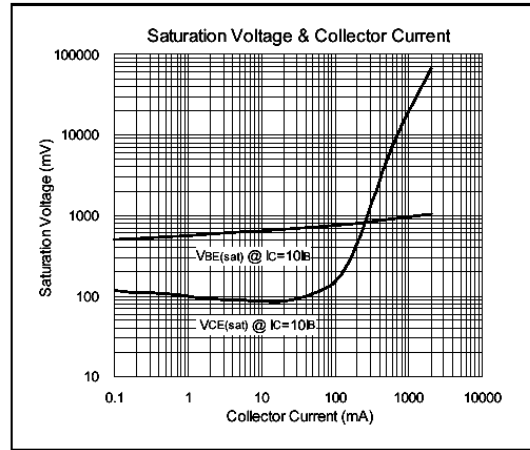
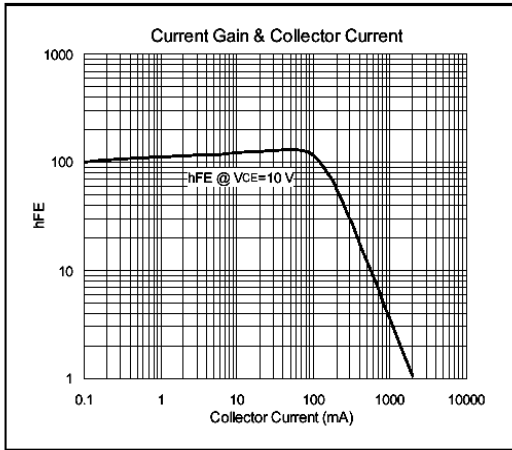

**Important Notice:**

- All rights are reserved. Reproduction in whole or in part is prohibited without the prior written approval of GTM.
- GTM reserves the right to make changes to its products without notice.
- GTM semiconductor products are not warranted to be suitable for use in life-support Applications, or systems.
- GTM assumes no liability for any consequence of customer product design, infringement of patents, or application assistance.

**Head Office And Factory:**

- **Taiwan:** No. 17-1 Tatung Rd. Fu Kou Hsin-Chu Industrial Park, Hsin-Chu, Taiwan, R. O. C.
- TEL: 886-3-597-7061 FAX: 886-3-597-9220, 597-0785
- **China:** (201203) No.255, Jang-Jiang Tsai-Lueng RD., Pu-Dung-Hsin District, Shang-Hai City, China
- TEL: 86-21-5895-7671 ~ 4 FAX: 86-21-38950165