



GMR20H125C

HIGH VOLTAGE POWER SCHOTTKY RECTIFIER

DESCRIPTION

Dual center tap schottky rectifier designed for high frequency miniature Switched Mode Power Supplies.

Major Ratings and Characteristics

Characteristics	Values	Unit
$I_{F(AV)}$ Rectangular waveform	2 X 10	A
V_{RRM}	125	V
V_F @10 Apk, $T_C = 125^\circ\text{C}$ (per leg)	0.68	V
T_J range	-45 ~ +150	$^\circ\text{C}$

FEATURES

- ◆ High junction temperature capability
- ◆ Good trade off between leakage current and forward voltage drop
- ◆ Low leakage current

TO-220AB

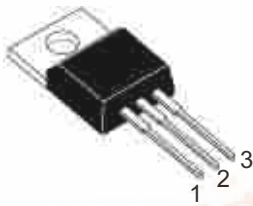

TO-263-2(D²PAK)

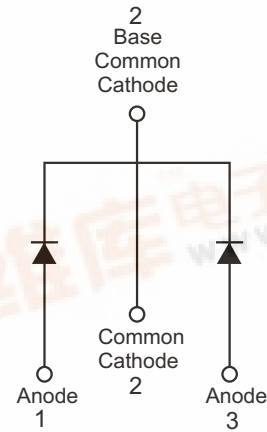
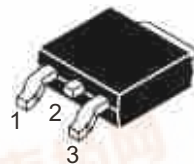

TO-220FPAB

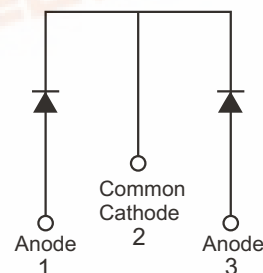
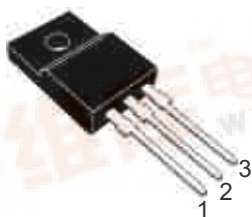

◆ MARKING INFORMATION

TO - 220AB

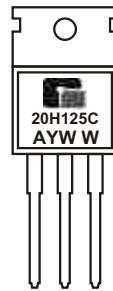

TO-263-2 (D²PAK)

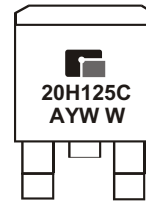

A : Assembly Location
 Y : Year
 WW : Weekly

◆ ORDERING INFORMATION

Ordering Number	Package	Shipping
GMR20H125CTA3T	TO - 263-2	50 Unit/ Tube
GMR20H125CTA3R	TO - 263-2	800 Unit/ Tape & Reel
GMR20H125CTB3T	TO - 220AB	50 Unit/ Tube
GMR20H125CTBF3T	TO - 220FPAB	50 Unit/ Tube

* For detail Ordering Number identification, please see last page.

◆ ABSOLUTE RATINGS (T_C = 25°C)

Symbol	Parameter	Value	Unit
V _{RRM}	Repetitive peak reverse voltage	125	V
I _{F(AV)}	Maximum average forward rectified current	10 20	A
I _{FSM}	Peak forward surge current 8.3ms single half sine-wave superimposed on rated load per leg. (Non-Repetitive)	200	A
T _j , T _{stg}	Operating junction temperature and storage temperature	-45 to + 150	°C

◆ **Thermal Characteristics** ($T_C = 25^\circ\text{C}$ unless otherwise noted)

Parameter	Symbol	TO-263-2	TO-220AB	TO-220FPAB	Unit
Typical thermal resistance per leg	$R_{\theta JC}$	2.0	2.0	4.0	$^\circ\text{C/W}$

◆ **Electrical Characteristics** ($T_C = 25^\circ\text{C}$ unless otherwise noted)

Parameter	Symbol	Value	Unit
Maximum instantaneous forward voltage per leg (Note 1)	$I_F = 10\text{A}, T_C = 25^\circ\text{C}$	0.80	V
	$I_F = 10\text{A}, T_C = 125^\circ\text{C}$	0.68	
	$I_F = 20\text{A}, T_C = 25^\circ\text{C}$	-	
	$I_F = 20\text{A}, T_C = 125^\circ\text{C}$	-	
Maximum reverse current per leg at working peak reverse voltage (Note 1)	$T_J = 25^\circ\text{C}$	10	μA
	$T_J = 125^\circ\text{C}$	10	mA

Note 1: Pulse Test: Pulse Width= 300 μs , Duty Cycle $\leq 2.0\%$

HIGH VOLTAGE POWER SCHOTTKY RECTIFIER

◆ TO-220AB PACKAGE OUTLINE DIMENSIONS

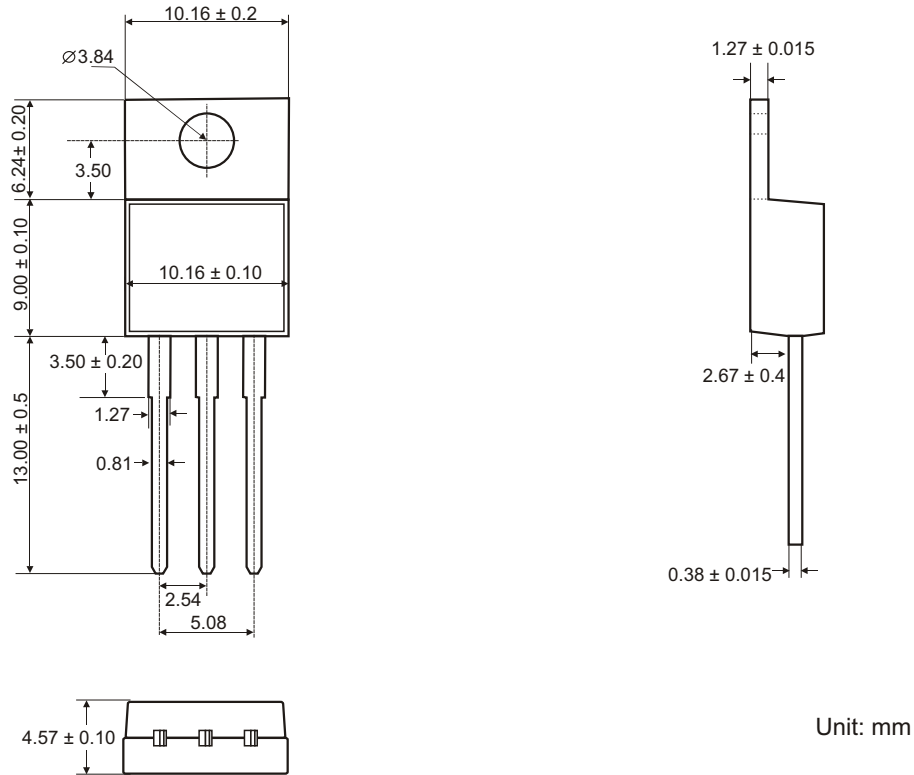

◆ TO-220FPAB PACKAGE OUTLINE DIMENSIONS

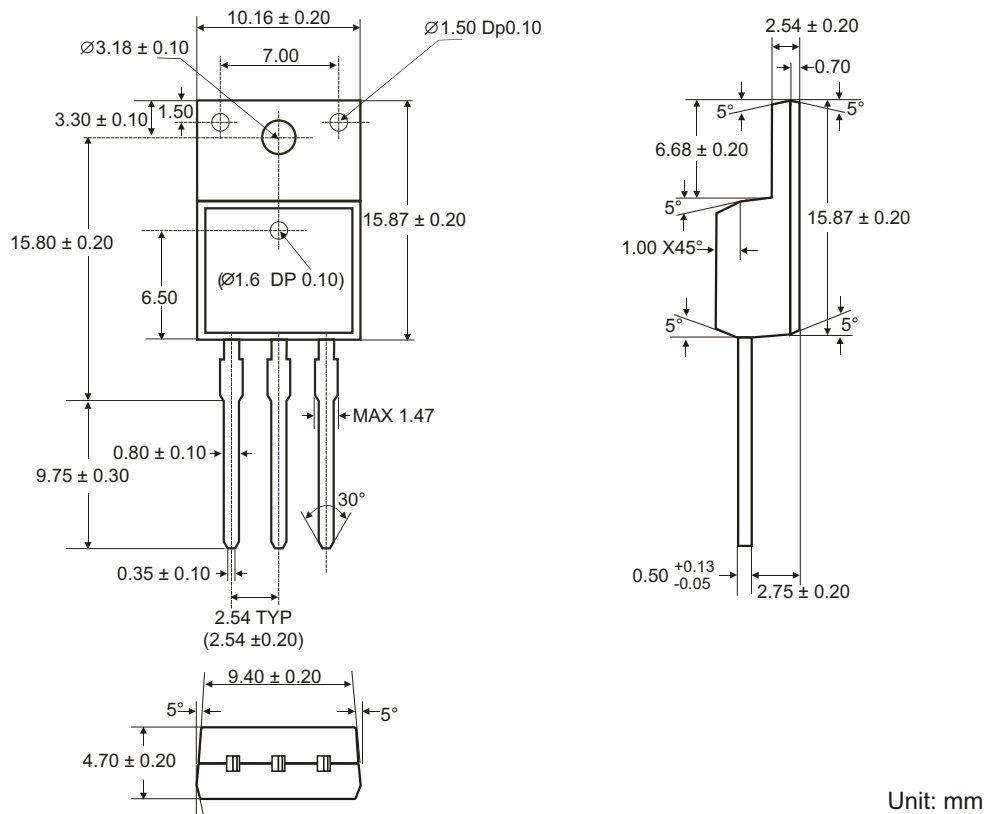

HIGH VOLTAGE POWER SCHOTTKY RECTIFIER

◆ TO-263-2 PACKAGE OUTLINE DIMENSIONS

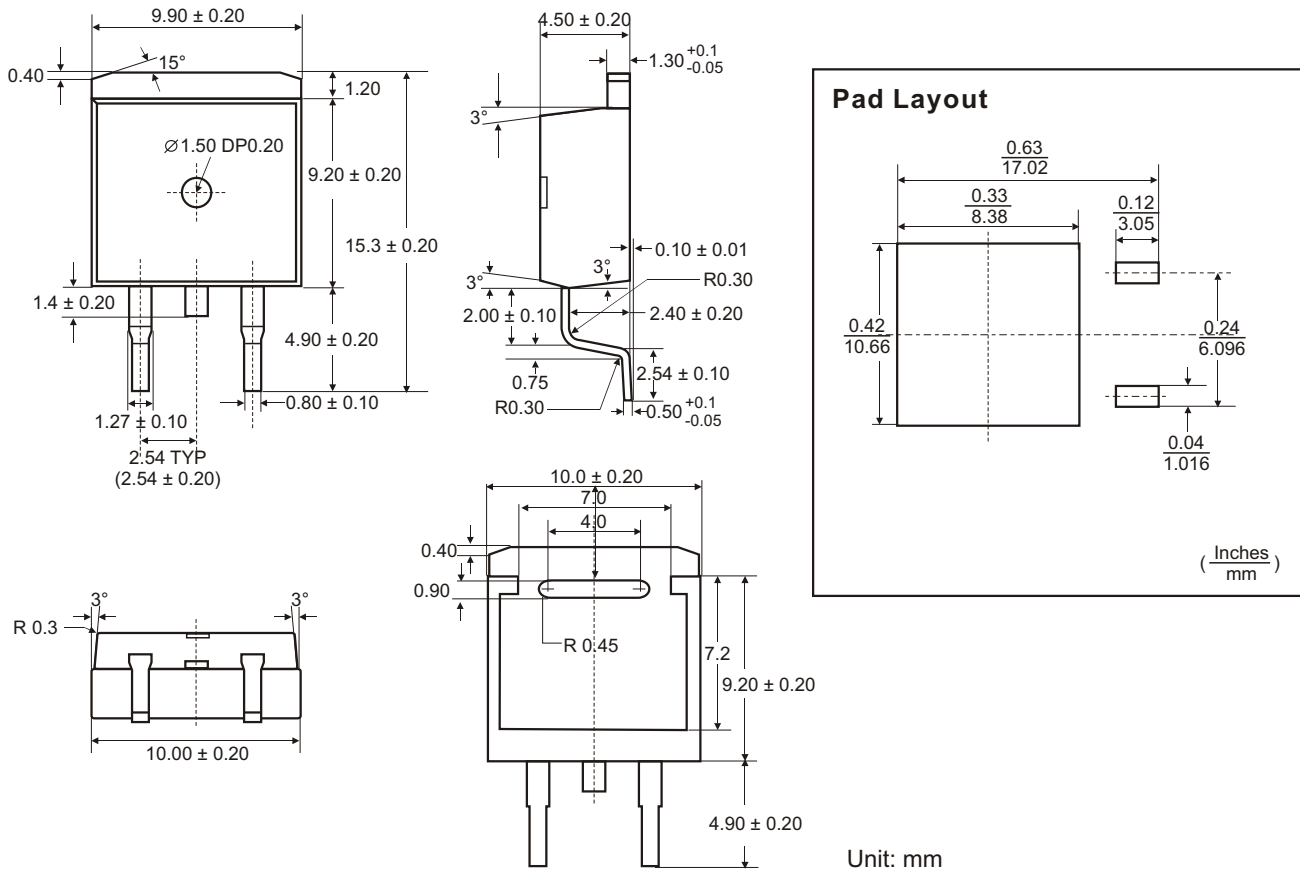

◆ ORDERING NUMBER

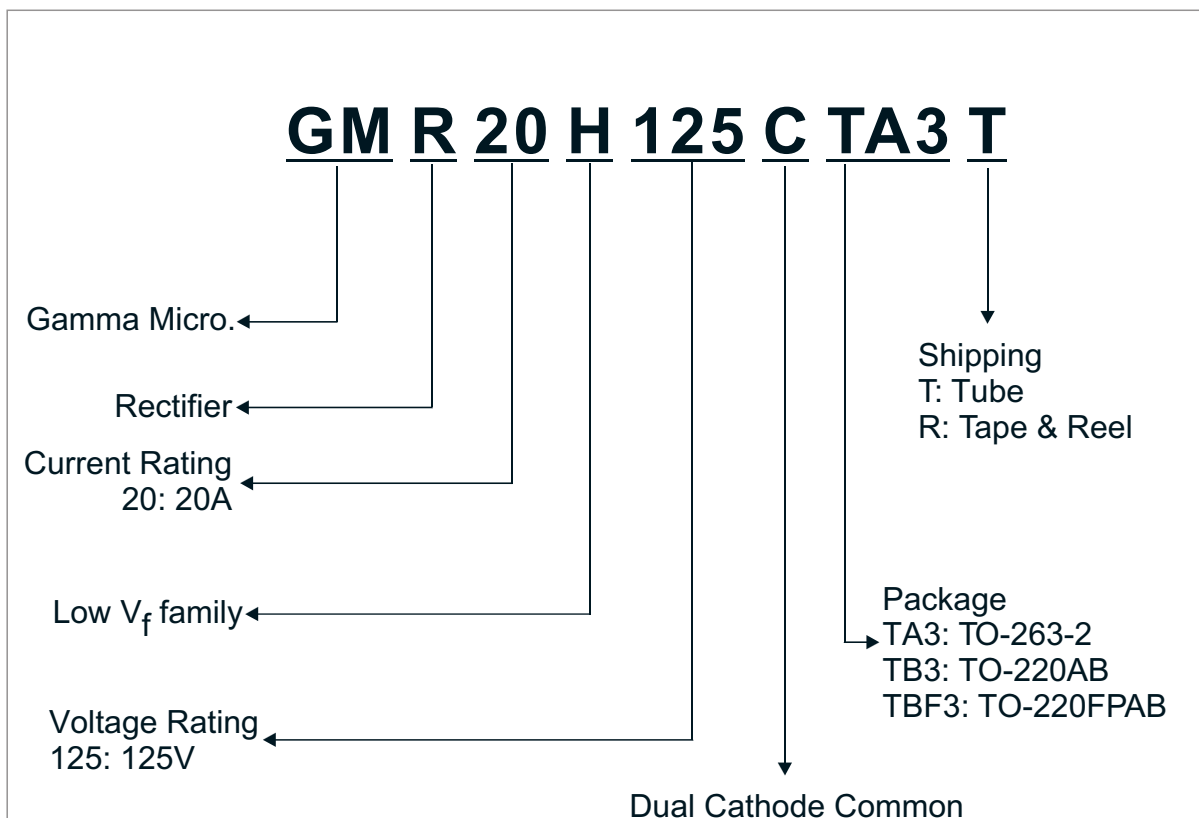





Power Discrete

GMR20H125C

HIGH VOLTAGE POWER SCHOTTKY RECTIFIER

GMR20H125C

GAMMA Micro, , and  are registered trademarks of GAMMA MICROELECTRONICS INC. GAMMA reserves the right to make changes without further notice to any products herein. Information provided herein is alleged to be exact and consistent and this publication surpasses and replaces all information previously supplied.

GAMMA makes no warranty the suitability of its products for any particular purpose, nor does GAMMA assume any liability arising out of the application or use of any product or circuit, and specifically disclaims any and all liability including without limitation special, consequential or incidental damages. GAMMA products are not authorized for using as critical components in life support devices or systems