

#### Key Features

- generates 1.485GHz or 1.485/1.001GHz signal for HD-LINX™II ICs
- low current consumption
- 50Ω output impedance
- operates from a single 2.5V supply
- 8 pin tape on reel
- Pb-free and RoHS Compliant

#### Applications

- VCO for the GS1560, GS1559 and GS9060 Deserializers, and the GS1532, GS1531 and GS9062 Serializers

#### Description

The GO1525 is a self contained, miniature Voltage Controlled Oscillator (VCO). It produces a clean

1.485GHz reference clock signal for the GS1560 and GS9060 deserializers, and for the GS1532 and GS9062 serializers. The control voltage range is from 1.0 volts to 1.5 volts and is derived from the on-chip PLLs. The GO1525 frequency can be pulled approximately 32MHz for every one volt of control.

The output level is typically -9.0dBm with low spurious and noise content. It is designed to drive 50Ω strip lines.

The VCO requires a single 2.5V supply and draws a maximum of 15mA of current. It is packaged in a miniature 8-pin proprietary surface mount package and operates over the normal commercial temperature range of 0°C to +70°C.

This component and all homogeneous subcomponents are RoHS compliant.

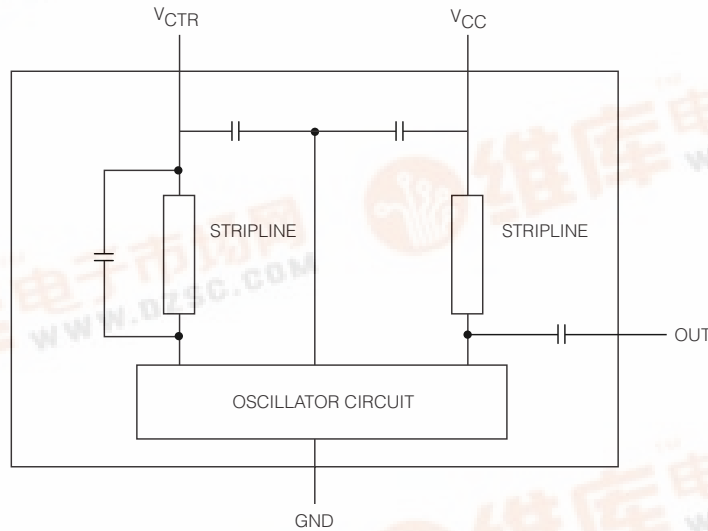

GO1525 Functional Block Diagram

# Contents

Key Features .....	1
Applications .....	1
Description .....	1
1. Pin Out .....	3
1.1 Pin Assignment .....	3
1.2 Pin Descriptions .....	3
2. Electrical Characteristics .....	4
3. Soldering Recommendations .....	5
3.1 Reflow Conditions .....	6
3.2 Soldering Flux .....	6
3.3 Rework or Repair .....	6
3.4 Endurance To Warp .....	6
4. Handling Recommendations .....	7
4.1 Cleaning .....	7
4.2 Storage .....	7
4.3 Transport .....	7
4.4 ESD Warning .....	7
5. Package & Ordering Information .....	8
5.1 Package Dimensions .....	8
5.2 Packaging Data .....	8
5.3 Ordering Information .....	8
6. Revision History .....	9

# 1. Pin Out

## 1.1 Pin Assignment

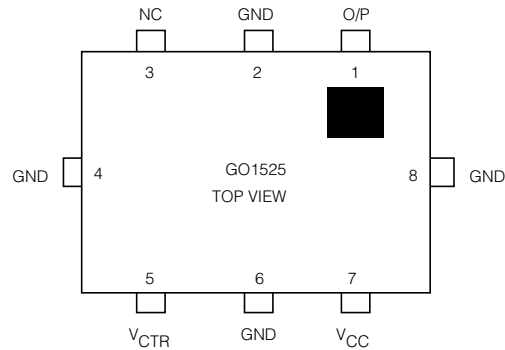

NOTE: Pin numbers are arbitrary  
There are no pin markings on the device itself

## 1.2 Pin Descriptions

**Table 1-1: Pin Descriptions**

Pin Number	Name	Type	Description
2, 4, 6, 8	GND	Power	Most negative power supply connections.
5	V <sub>CTR</sub>	Input	Control voltage for the VCO.
7	V <sub>CC</sub>	Power	Most positive power supply connection.
1	O/P	Output	VCO signal output.
3	NC	–	No connection.

Note: Pin numbering different from GO1515

## 2. Electrical Characteristics

**Table 2-1: Electrical Characteristics**

$V_{CC} = 2.5V \pm 0.25V$ , Temperature =  $0^{\circ}C$  to  $70^{\circ}C$ , unless otherwise shown

Parameter	Symbol	Conditions	Min	Typ	Max	Units	Notes
Supply Voltage	$V_{CC}$	–	2.25	2.5	2.75	V	Supply Voltage
Supply Current	$I_S$	–	–	–	15	mA	Supply Current
Control Voltage Range	$V_{CTR}$	–	1.0	–	1.5	V	Control Voltage Range
Control Voltage Sensitivity	$df/dV$	–	25	32	39	MHz/V	Control Voltage Sensitivity
Operating Frequency Range	$f_{VCO}$	$V_{CTR} = 1.0V$	1483.5	–	–	MHz	Operating Frequency Range
		$V_{CTR} = 1.5V$	–	–	1485.0	MHz	
Output Signal Level	$V_{OUT}$	–	-12	-9	-6	dBm	Output Signal Level
Pushing Figure	–	$V_{CC} = 2.5V \pm 0.25V$ , ref: $V_{CC} = 2.5V$	–	1.5	–	MHz	Pushing Figure
Pulling Figure	–	VSWR = 2.0 for all phase, ref: $50\Omega$	–	1.0	–	MHz	Pulling Figure
Temperature Stability	$T_{COEF}$	$0^{\circ}C$ to $70^{\circ}C$ , ref. = $25^{\circ}C$	–	–	$\pm 3$	MHz	Temperature Stability
Spurious Response	–	–	–	–	-10	dBc	Spurious Response
Output Impedance	$Z_O$	–	–	50	–	$\Omega$	Output Impedance

### 3. Soldering Recommendations

The device is manufactured with Matte-Sn terminations and is compatible with both standard eutectic and Pb-free solder reflow profiles. The recommended standard eutectic reflow profile is shown in Figure 3-1. The maximum recommended Pb-free reflow profile is shown in Figure 3-2.

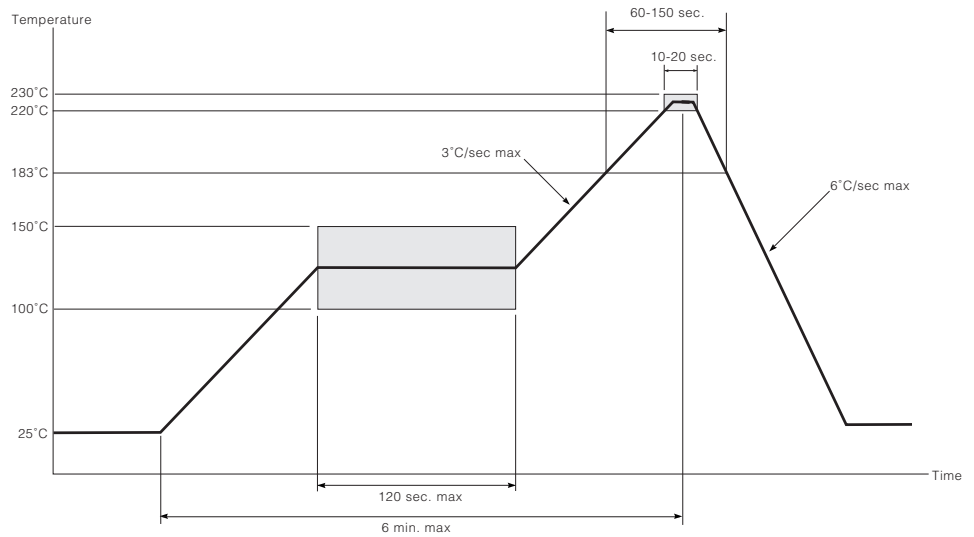

Figure 3-1: Standard Eutectic Solder Reflow Profile

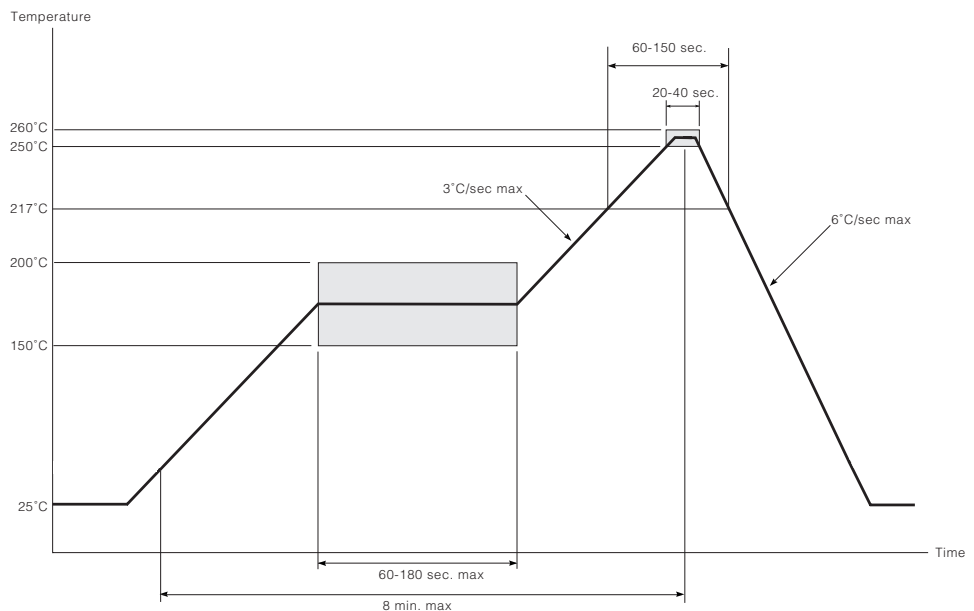

Figure 3-2: Maximum Pb-free Solder Reflow Profile

### 3.1 Reflow Conditions

The device will meet the data sheet specifications after completing the reflow process according to the profile shown in [Figure 3-1](#) or [Figure 3-2](#). Recommended soldering conditions are as follows:

Preheating	150±10°C, 60 to 120 sec.
Soldering	Peak 260°C
	Over 200°C within 30 sec.

### 3.2 Soldering Flux

Do not use cleaning type flux. Washing the devices after using cleaning type flux may damage inner parts and affect performance.

### 3.3 Rework or Repair

Rework or repair must only be done once. Do not reflow the device more than twice; once for initial soldering and once for remounting after rework.

Do not vibrate the VCO during reflow soldering.

### 3.4 Endurance To Warp

When the device is soldered on a printed circuit board (dimension: 100mm x 100mm; thickness: 1.6mm) and the PCB is warped as shown in [Figure 3-2](#), the device will not be cracked or damaged.

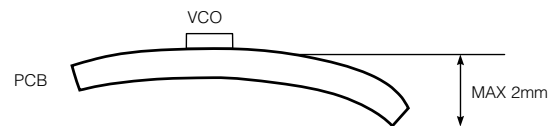

**Figure 3-3: PCB Warp**

## 4. Handling Recommendations

### 4.1 Cleaning

There are two options for cleaning the devices.

Option 1:

1. Clean but do not use solvent cleaners.
2. Thoroughly dry assemblies afterwards.

Option 2:

1. Mount device after board is cleaned.

### 4.2 Storage

Store the devices out of direct sunlight, at a stable temperature and humidity. Avoid extreme temperatures, high humidity and wide temperature fluctuations. Condensation on the devices may result in reduced quality and lowered solderability.

Avoid dust, sea breezes and corrosive gases ( $\text{Cl}_2$ ,  $\text{NH}_3$ ,  $\text{SO}_2$ ,  $\text{NO}_x$ , etc.).

Use within 6 months after delivery. If the devices are stored for more than one year, solderability may be degraded.

### 4.3 Transport

Package the devices for transportation to avoid mechanical vibration or shock.

### 4.4 ESD Warning

Avoid poor ground connections and electrostatic discharge or induction in production.

## 5. Package & Ordering Information

### 5.1 Package Dimensions

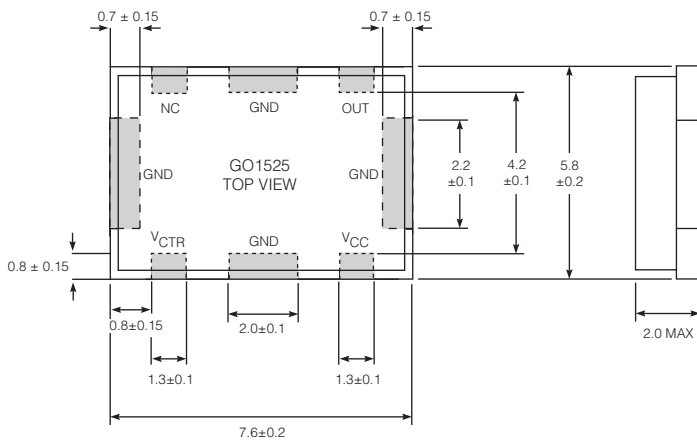

All dimensions in millimetres

Recommended Footprint for PCB Layout

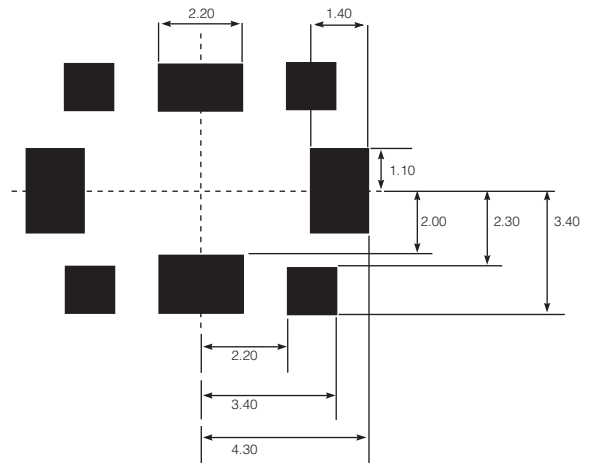

All dimensions in millimetres

### 5.2 Packaging Data

Parameter	Value
Package Type	8L Proprietary Surface Mount
Package Drawing Reference	21307 rev.0
Pb-free and RoHS Compliant	Yes

### 5.3 Ordering Information

Part Number	Package	Temperature Range	Pb-Free	RoHS Compliant
GO1525-CTAE3	8-pin tape on reel	0°C to 70°C	Yes	Yes



## 6. Revision History

Version	ECR	Date	Changes/Modification
0	120395	January 2002	New Document
1	125583	July 2002	Update Document from AIN to Data Sheet. Changed Supply Voltage Range in Electrical Characteristics Table.
2	127841	February 2003	More detailed information added to the soldering and handling recommendations sections. Document reformatted.
3	133240	March 2004	Corrected package dimensions and added new footprint.
4	133445	July 2004	Added 'Pb-free' bullet. Added Pb-free solder reflow profile.
5	134964	November 2004	Adding Pb-Free and Green Ordering Information. Converting to new document template. Adding packaging data information. Adding Solder Reflow Profile description. Updating product cleaning information.
6	136564	April 2005	Changed 'Green' references to RoHS Compliant.
7	137164	June 2005	Rephrased RoHS compliance statement.
8	137624	July 2005	Corrected packages list in Ordering Information on page 8. Corrected description of Pb-free profile in Soldering Recommendations on page 5

### CAUTION

ELECTROSTATIC SENSITIVE DEVICES  
DO NOT OPEN PACKAGES OR HANDLE  
EXCEPT AT A STATIC-FREE WORKSTATION



### DOCUMENT IDENTIFICATION

#### DATA SHEET

The product is in production. Gennum reserves the right to make changes to the product at any time without notice to improve reliability, function or design, in order to provide the best product possible.

### GENNUM CORPORATION

Mailing Address: P.O. Box 489, Stn. A, Burlington, Ontario, Canada L7R 3Y3  
Shipping Address: 970 Fraser Drive, Burlington, Ontario, Canada L7L 5P5  
Tel. +1 (905) 632-2996 Fax. +1 (905) 632-5946

### GENNUM JAPAN CORPORATION

Shinjuku Green Tower Building 27F, 6-14-1, Nishi Shinjuku, Shinjuku-ku, Tokyo, 160-0023 Japan  
Tel. +81 (03) 3349-5501, Fax. +81 (03) 3349-5505

### GENNUM UK LIMITED

25 Long Garden Walk, Farnham, Surrey, England GU9 7HX  
Tel. +44 (0)1252 747 000 Fax +44 (0)1252 726 523

Gennum Corporation assumes no liability for any errors or omissions in this document, or for the use of the circuits or devices described herein. The sale of the circuit or device described herein does not imply any patent license, and Gennum makes no representation that the circuit or device is free from patent infringement.

GENNUM and the G logo are registered trademarks of Gennum Corporation.

© Copyright 2002 Gennum Corporation. All rights reserved. Printed in Canada.

www.gennum.com