



# 1A Adjustable Low-Dropout Linear Regulator

## Features

- Available in adjust version
- Space saving TO-252, SOT-223 and TO-92 package
- Internal short circuit current limiting
- Internal over temperature protection
- Output current in excess of 1A
- Output current in excess of 100mA with TO-92 package

## Applications

- Post regulation for switching DC/DC converter
- High efficiency linear regulator
- Battery charger
- Battery powered instrumentation
- Motherboard

## General Description

The G1117 is a low dropout linear regulator with a dropout of 1.2V at 800mA of load current and 1.3V at 1A of load current. It is available in an adjustable version, which can set the output from 1.25V to 5V with only two external resistors.

The G1117 provides over temperature and over current protection circuits to prevent it from being damaged by abnormal operating conditions.

The G1117 is available in TO-252, SOT-223 and TO-92 packages. A minimum of 10µF tantalum electrolytic capacitor is required at the output to improve the transient response and stability.

## Ordering Information

ORDER NUMBER	ORDER NUMBER (Pb free)	MARKING	TEMP. RANGE	PACKAGE	PIN OPTION		
					1	2	3
G1117T43U	G1117T43Uf	G1117	-40°C~85°C	TO-252	GND/ADJ	V <sub>OUT</sub>	V <sub>IN</sub>
G1117T63U	G1117T63Uf	G1117	-40°C~85°C	SOT-223	GND/ADJ	V <sub>OUT</sub>	V <sub>IN</sub>
----	G1117TD3B	G1117	-40°C~85°C	TO-92	GND/ADJ	V <sub>OUT</sub>	V <sub>IN</sub>

\* For other package types and pin options, please contact us at sales@gmt.com.tw

## Order Number Identification

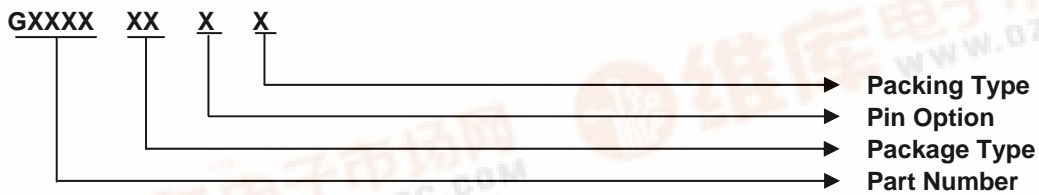

### PACKAGE TYPE

T4: TO-252  
T6: SOT-223  
TD: TO-92

### PIN OPTION

1 2 3  
3: GND/ADJ V<sub>OUT</sub> V<sub>IN</sub>

### PACKING

U: Tape & Reel  
B: Bag

## Package Type

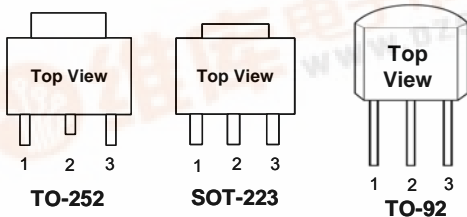

## Typical Application

[Note 4]: Type of C<sub>OUT</sub>

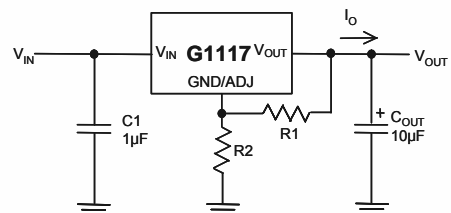



<b>Absolute Maximum Ratings</b>	(Note 1)
Input Voltage	7V
Power Dissipation Internally Limited	(Note 2)
Maximum Junction Temperature	150°C
Reflow Temperature (soldering, 10sec)	260°C
Thermal Resistance Junction to Ambient, ( $\theta_{JA}$ )	
SOT-223	116°C/W
Thermal Resistance Junction to Case, ( $\theta_{JC}$ )	
SOT-223	21°C/W

<b>Operating Conditions</b>	(Note 1)
( $V_{IN}-V_{ADJ}$ ) Voltage	2.5V~6.5V
Temperature Range	-40°C ≤ T <sub>A</sub> ≤ 85°C

Note <sup>(1)</sup>: See Recommended Minimum Footprint

## Electrical Characteristics

Operating Conditions: V<sub>IN</sub> ≤ 6.5V, T<sub>J</sub> = 25°C unless otherwise specified. [Note3]

PARAMETER	CONDITIONS	MIN	TYP	MAX	UNITS
Reference Voltage	V <sub>IN</sub> - V <sub>OUT</sub> = 2V, I <sub>OUT</sub> = 10mA	1.225	1.250	1.275	V
Line Regulation	(V <sub>OUT</sub> + 1.5V) ≤ V <sub>IN</sub> ≤ 6.5V, I <sub>OUT</sub> = 10mA	---	1.32	---	%
Load Regulation	(V <sub>IN</sub> - V <sub>OUT</sub> ) = 2V, 10mA < I <sub>OUT</sub> < 1A	---	0.04	---	%
Dropout Voltage	ΔV <sub>OUT</sub> = 2%, I <sub>OUT</sub> = 800mA	---	1.2	1.3	V
	ΔV <sub>OUT</sub> = 2%, I <sub>OUT</sub> = 1A	---	1.3	1.4	
Current Limit	(V <sub>IN</sub> - V <sub>OUT</sub> ) = 2V	1000	1200	---	mA
Adjust Pin Current Change	V <sub>IN</sub> - V <sub>OUT</sub> = 2V, 10mA ≤ I <sub>OUT</sub> ≤ 1A	---	0.15	---	μA
Minimum Load Current	1.5V ≤ (V <sub>IN</sub> - V <sub>OUT</sub> ) ≤ 5.25V	10	---	---	mA
Quiescent Current	V <sub>IN</sub> - V <sub>OUT</sub> = 2V	30	80	150	μA
Ripple Rejection	f = 120Hz, C <sub>OUT</sub> = 10μF Tantalum, (V <sub>IN</sub> - V <sub>OUT</sub> ) = 3V, I <sub>OUT</sub> = 800mA	---	50	---	dB
Thermal Regulation	T <sub>A</sub> = 25°C, 30ms pulse	---	0.004	0.02	%/W
Temperature Stability	V <sub>IN</sub> = 4V, I <sub>O</sub> = 10mA	---	0.3	---	%
RMS Output Noise (% of V <sub>OUT</sub> )	T <sub>A</sub> = 25°C, 10Hz ≤ f ≤ 10kHz, I <sub>LOAD</sub> = 10mA	---	0.007	---	%
Thermal Resistor Junction-to-Ambient (No heat sink; No air flow)	SOT-223; Recommended Minimum Footprint	---	116	---	°C/W
Thermal Shutdown	Junction Temperature	---	150	---	°C
Thermal Shutdown Hysteresis		---	10	---	°C

**Note1:** Absolute Maximum Ratings are limits beyond which damage to the device may occur. Operating Conditions are conditions under which the device functions but the specifications might not be guaranteed. For guaranteed specifications and test conditions see the Electrical Characteristics.

**Note2:** The maximum power dissipation is a function of the maximum junction temperature, T<sub>Jmax</sub>; total thermal resistance, θ<sub>JA</sub>, and ambient temperature T<sub>A</sub>. The maximum allowable power dissipation at any ambient temperature is T<sub>Jmax</sub>-T<sub>A</sub> / θ<sub>JA</sub>. If this dissipation is exceeded, the die temperature will rise above 150°C and IC will go into thermal shutdown. For the G1117 in SOT-223 package; θ<sub>JA</sub> is 116°C/W (See recommend minimum footprint).

**Note3:** Low duty pulse techniques are used during test to maintain junction temperature as close to ambient as possible.

**Note4:** The type of output capacitor should be tantalum or aluminum.



## Definitions

### Output Voltage

The G1117 provides an adjustable output voltage from 1.25V to 5V. With two external resistors. It can be formulated as:

$$V_{OUT} = 1.25V \times \left(1 + \frac{R_2}{R_1}\right) + I_{ADJ} \times R_2$$

$$I_{ADJ} = 80\mu A \text{ (TYP.)}$$

### Dropout Voltage

The input/output Voltage differential at which the regulator output no longer maintains regulation against further reductions in input voltage. Measured when the output drops 2% below its nominal value. Dropout voltage is affected by junction temperature, load current and minimum input supply requirements.

### Line Regulation

The change in output voltage for a change in input

voltage. The measurement is made under conditions of low dissipation or by using pulse techniques such that average chip temperature is not significantly affected.

### Load Regulation

The change in output voltage for a change in load current at constant chip temperature. The measurement is made under conditions of low dissipation or by using pulse techniques such that average chip temperature is not significantly affected.

### Maximum Power Dissipation

The maximum total device dissipation for which the regulator will operate within specifications.

### Quiescent Bias Current

Current which is used to operate the regulator chip and is not delivered to the load.



Typical Performance Characteristics

V<sub>IN</sub>= 4V, C<sub>IN</sub>= 10μF, C<sub>OUT</sub>=10μF, T<sub>A</sub>=25°C, unless otherwise noted.

Line transient

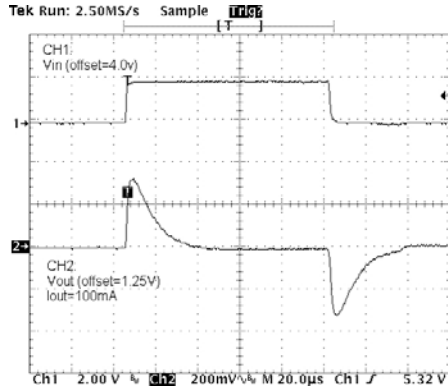

Load Transient

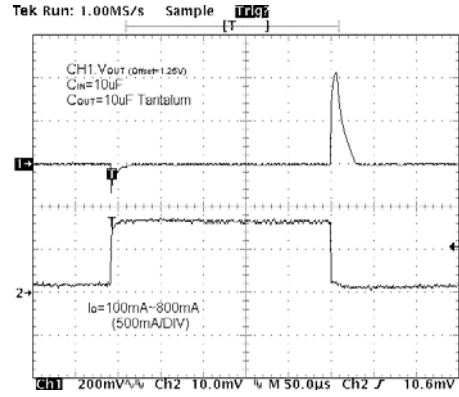

Dropout Voltage vs. Load Current

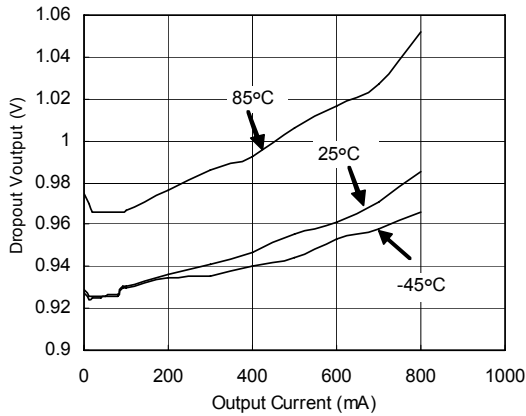

I<sub>ADJ</sub> Current vs. Load Current

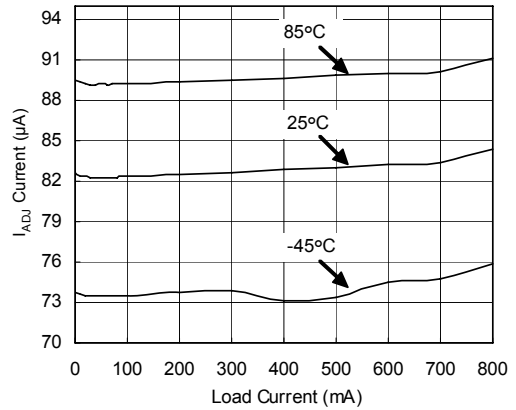

Ripple Rejection

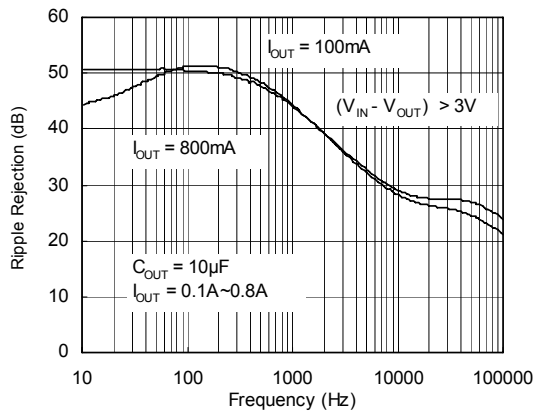

Temperature Stability

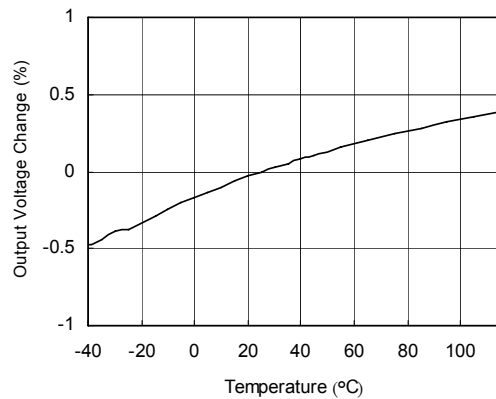



Typical Performance Characteristics (continued)

Output Noise

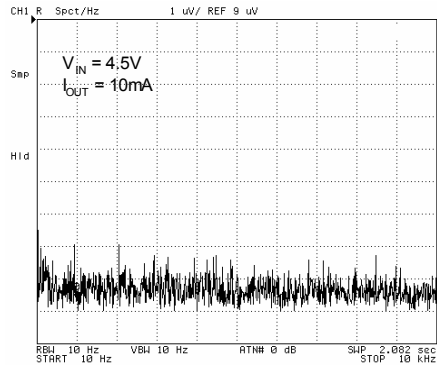

Short-Circuit Current

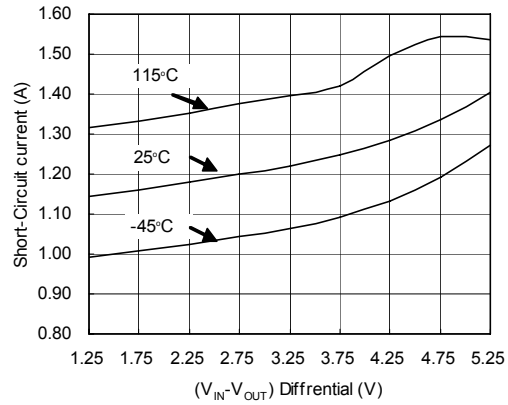

Load Regulation

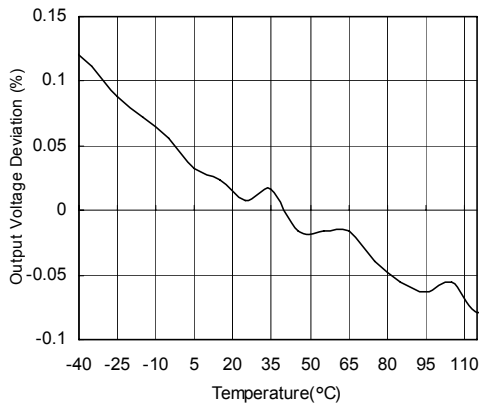

Overcurrent Protection Characteristics

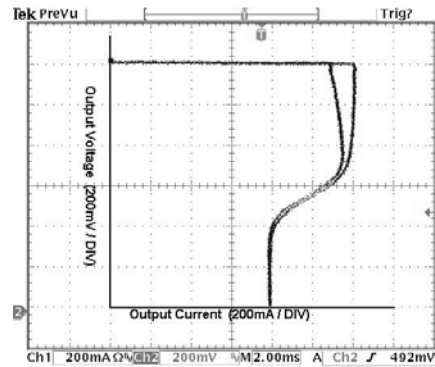

SOT-223 Max. Power Dissipation vs. PCB Top Copper Area

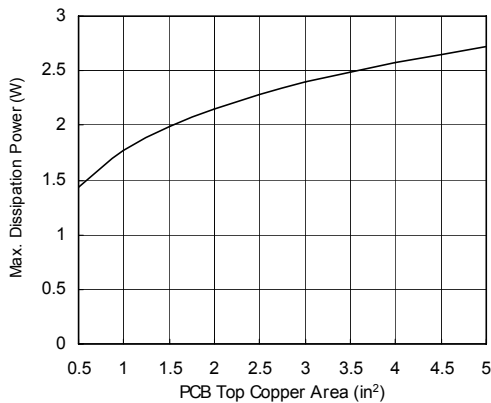

SOT-223 Max. Power Dissipation vs. T<sub>AMB</sub>

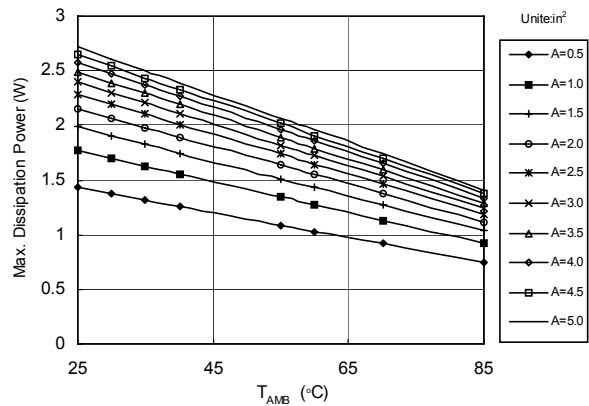



Recommended Minimum Footprint

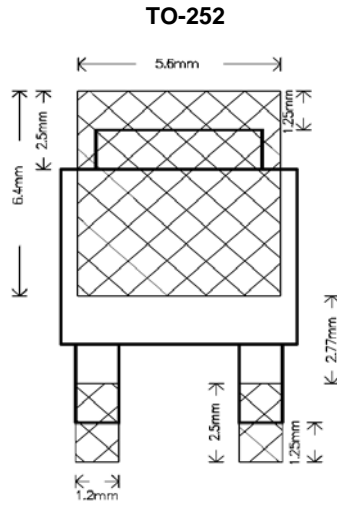
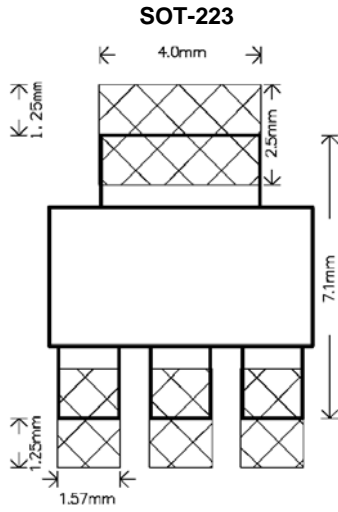



## Package Information

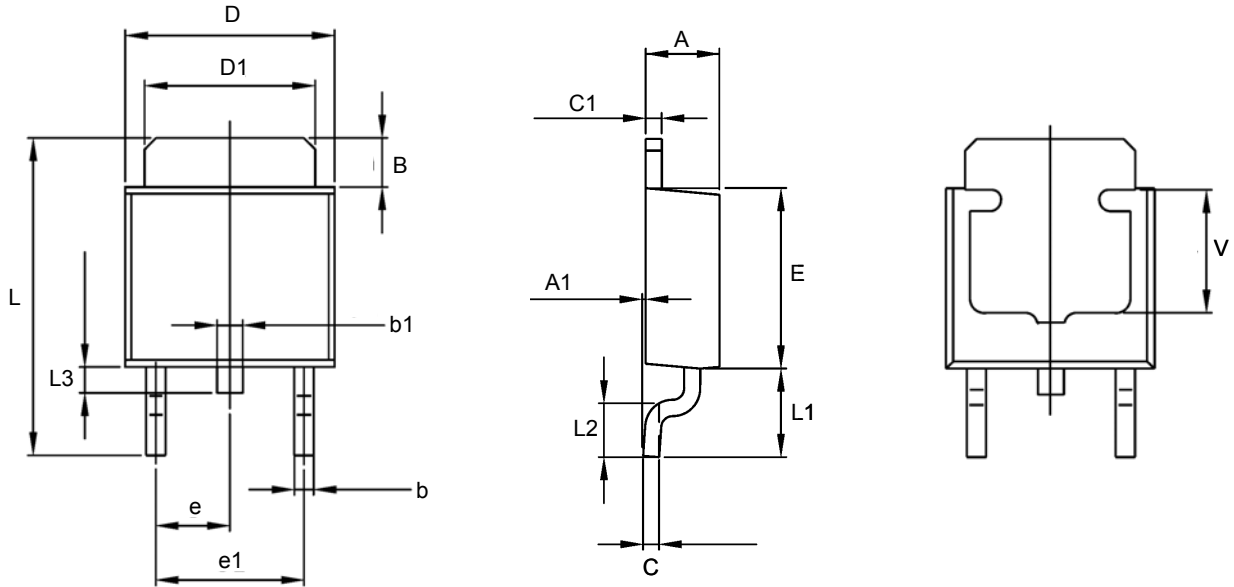

TO-252 (T4) Package

SYMBOL	MILLIMETERS		INCHES	
	MIN.	MAX.	MIN.	MAX.
A	2.190	2.400	0.086	0.094
A1	0.000	0.127	0.000	0.005
B	0.880	1.650	0.035	0.065
b	0.500	0.880	0.020	0.035
b1	0.700	0.900	0.028	0.035
C	0.430	0.580	0.017	0.023
C1	0.430	0.580	0.017	0.023
D	6.350	6.730	0.250	0.265
D1	5.200	5.460	0.205	0.215
E	5.400	6.220	0.213	0.245
e	2.300 TYP		0.091 TYP	
e1	4.500	4.700	0.177	0.185
L	8.830	10.77	0.348	0.424
L1	2.550	2.900	0.100	0.114
L2	1.400	1.780	0.055	0.070
L3	0.350	1.020	0.014	0.040
V	3.800	4.320	0.150	0.170

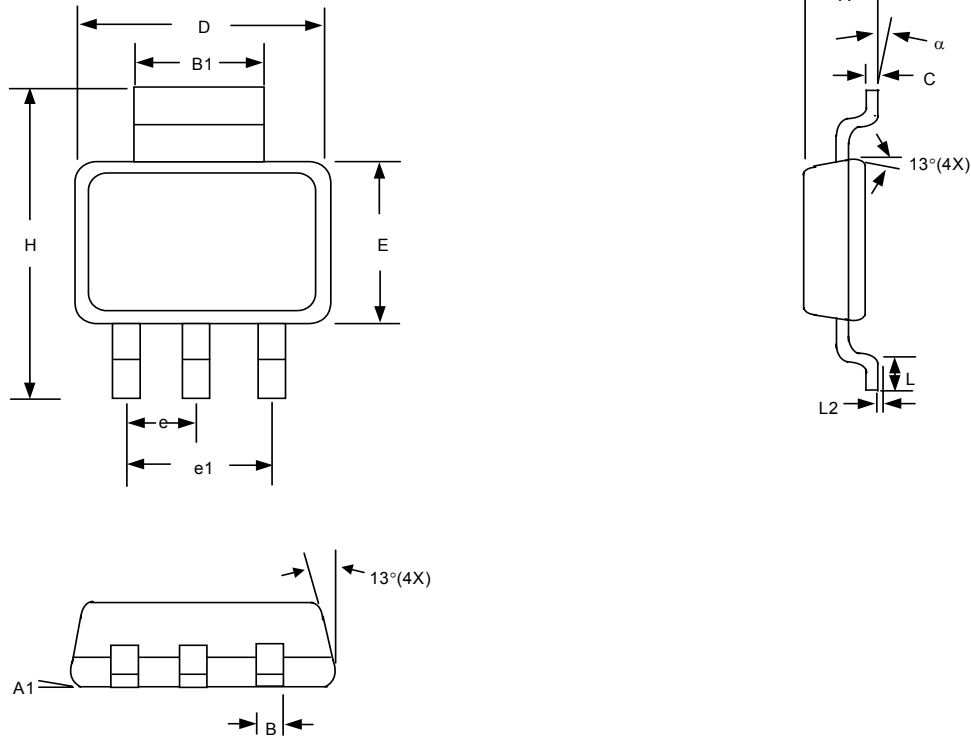

SOT-223 (T6) Package

SYMBOLS	MILLIMETERS		INCHES	
	MIN	MAX	MIN	MAX
A	1.55	1.80	0.061	0.071
A1	0.02	0.12	0.0008	0.0047
B	0.60	0.80	0.024	0.031
B1	2.90	3.10	0.114	0.122
C	0.24	0.32	0.009	0.013
D	6.30	6.70	0.248	0.264
E	3.30	3.70	0.130	0.146
e	2.30 BSC		0.090 BSC	
e1	4.60 BSC		0.181 BSC	
H	6.70	7.30	0.264	0.287
L	0.90 MIN		0.036 MIN	
L2	0.06 BSC		0.0024 BSC	
$\alpha$	0°	10°	0°	10°



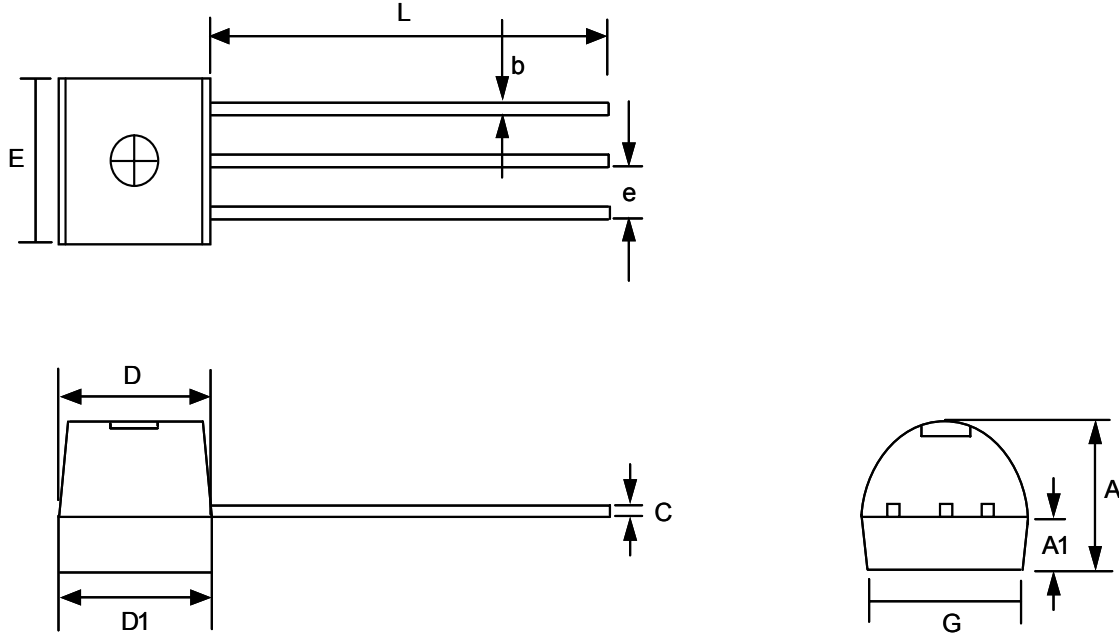

TO-92 (TD) Package

SYMBOL	MILLIMETER		INCH	
	MIN	MAX	MIN	MAX
A	3.35	3.86	0.132	0.152
A1	1.0414	1.55	0.041	0.061
b	0.254	0.508	0.010	0.020
E	4.34	4.85	0.171	0.191
C	0.254	0.508	0.010	0.020
L	14.53	15.04	0.572	0.592
e	1.143	1.397	0.045	0.055
G	3.683	4.191	0.145	0.165
D	4.29	4.80	0.169	0.189
D1	4.34	4.85	0.171	0.191

Package Specification

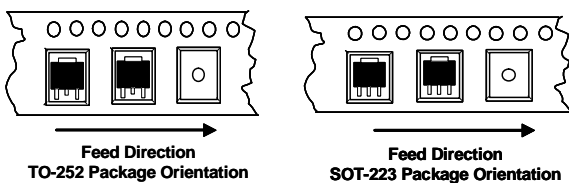

PACKAGE	Q'TY/REEL	Q'TY/BY BAG
TO-252	2,500 ea	-----
SOT-223	2,500 ea	-----
TO-92	-----	2,000 ea

GMT Inc. does not assume any responsibility for use of any circuitry described, no circuit patent licenses are implied and GMT Inc. reserves the right at any time without notice to change said circuitry and specifications.