



Stereo Headphone Power Amplifier

Features

- High performance Class AB amplifier
- High signal-to-noise ratio
- Low distortion
- Low power consumption
- Large output voltage swing
- Excellent power supply ripple rejection
- 3.0V to 6.5V supply voltage range
- Surface-Mount package-SOP 8

Applications

- CD-ROM
- DVD-ROM
- CD-R/W
- MP3
- Portable Stereo

General Description

The G1402 is an output rail-to-rail stereo audio power amplifier housed in a 8-pin SOP package capable of delivering 125mW of continuous power into 16Ω loads & 75mW into 32Ω loads with the THD <0.1% per channel.

The gain setting of the amplifiers can simply achieve by setting two external resistors R_i (input resistor) & R_f (feedback resistor) promptly.

The G1402 is a dual channel, low voltage, low power, and high performance amplifiers. The quiescent current is 3mA @ 5V typically. With excellent AC performance (small THD), it can be designed into a wide range of headphone driving applications.

Ordering Information

ORDER NUMBER	MARKING	TEMP. RANGE	PACKAGE
G1402P1X	G1402	-40°C to +85°C	SOP-8L
G1402P1Xf	G1402	-40°C to +85°C	SOP-8L (Pb free)

Note: X Specify the packing type

U: Tape & Reel

T: Tube

Pin Configuration

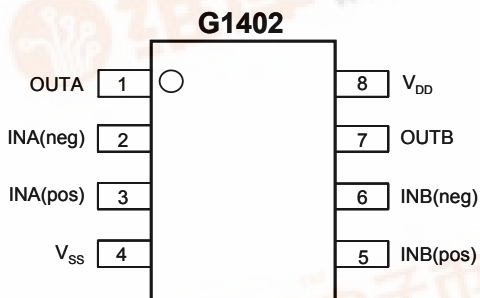

SYMBOL	PIN	DESCRIPTION
OUTA	1	output A
INA(neg)	2	inverting input A
INA(pos)	3	non-inverting input A
V_{SS}	4	negative supply
INB(pos)	5	non-inverting input B
INB(neg)	6	inverting input B
OUTB	7	output B
V_{DD}	8	positive supply



Block Diagram

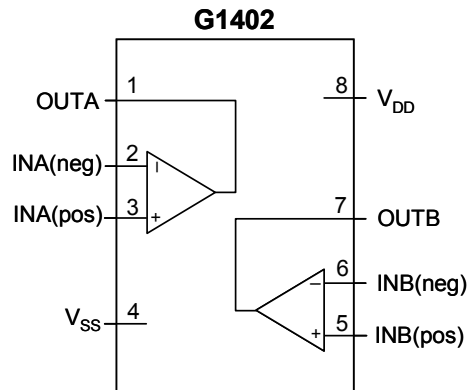

Absolute Maximum Ratings (Note1)

SYMBOL	PARAMETER	CONDITION	MIN	MAX	UNIT
V_{DD}	Supply voltage		0	7.0	V
T_{stg}	Storage temperature		-65	+150	°C
T_{amb}	Operating ambient temperature		-40	+85	°C
ESD	ESD voltage	HBM	-	2	KV

Notes:

1. Absolute Maximum Ratings are limits beyond which damage to the device may occur.

Thermal Characteristics

SYMBOL	PARAMETER	VALUE	UNIT
$R_{th(j-a)}$	Thermal resistance from junction to ambient in free air SO8	240	°C/W

Test and Application Information

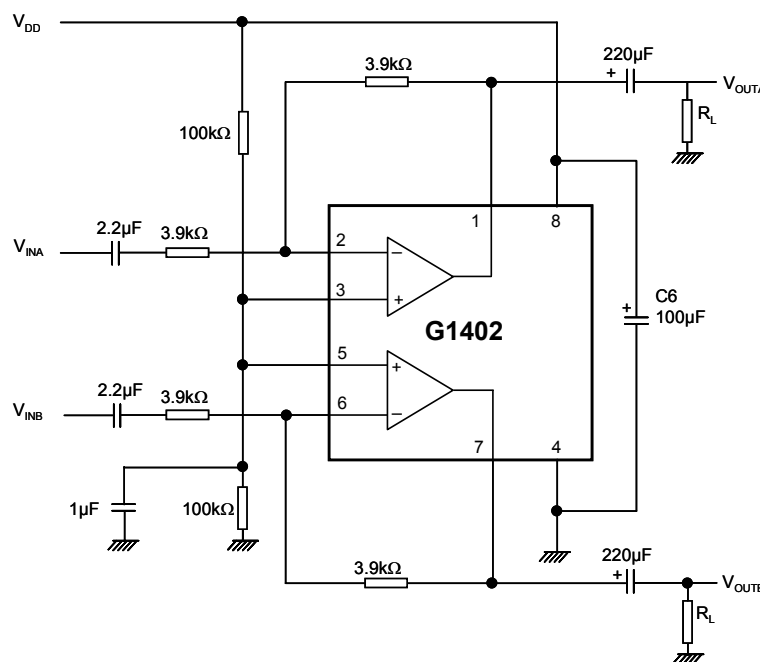

Fig.1 Measurement circuit for inverting application

**Electrical Characteristics** $V_{DD} = 5V$; $V_{SS} = 0V$; $T_A = 25^\circ C$; $f_i = 1kHz$; $R_L = 32\Omega$ connected to $V_{DD}/2$; unless otherwise specified.

SYMBOL	PARAMETER	CONDITION	MIN	TYP	MAX	UNIT
Supplies						
V_{DD}	Supply voltage		3.0	5.0	6.5	V
	Single		3.0	5.0	6.5	V
	Dual		1.5	2.5	3.25	V
V_{SS}	Negative supply voltage		-1.5	-2.5	-3.25	V
I_{DD}	Supply current	no load	-	3.0	5.0	mA
P_{tot}	Total power dissipation	no load	-	15	25	mW
DC Characteristics						
$V_{I(OS)}$	Input offset voltage		-50	-	50	mV
V_{CM}	Common mode voltage		0	-	3.5	V
G_V	Open-loop voltage gain	$R_L = 5k\Omega$	60	90	-	dB
I_O	Maximum output current	THD+N < 0.1%	-	70	-	mA
R_O	Output resistance	closed-loop	-	0.1	-	Ω
$V_{DD}-V_{OH}$	Output Voltage Swing High	Sourcing current = 100mA	-	0.4	1	V
$V_{OL}-V_{SS}$	Output Voltage Swing Low	Sinking current = 100mA	-	0.5	1	V
PSRR	Power supply rejection ratio	$f_i = 1kHz$; $V_{ripple(rms)} = 100mV_{rms}$	-	70	-	dB
α_{CS}	Channel separation	$R_L = 32\Omega, C_b = 1\mu F, P_O = 70mW$	-	65	-	dB
AC Characteristics						
THD	Total harmonic distortion	note 2	-	< 0.1	-	%
f_G	Unity gain frequency	open-loop; $R_L = 5k\Omega$	-	5	-	MHz
P_O	Maximum output power	note 1; $R_L = 16\Omega$; $f = 1kHz$	-	125	-	mW
		note 1; $R_L = 32\Omega$; $f = 1kHz$	-	75	-	mW

Notes:

- Values are proportional to V_{DD} ; THD+N < 0.1%
- $V_{DD} = 5.0V$; $V_{O(P-P)} = 4.0V$ (at 0 dB)



Electrical Characteristics

$C_{IN}=2.2\mu F$, $C_{OUT}=330\mu F$, $C_b=1\mu F$, $A_v=1$, $R_i=18k$, $R_f=18k$; $A_v=-2$, $R_i=18k$, $R_f=36k$; $A_v=-4$, $R_i=9k$, $R_f=36k$, $T_A=25^\circ C$

THD+N vs Output Power

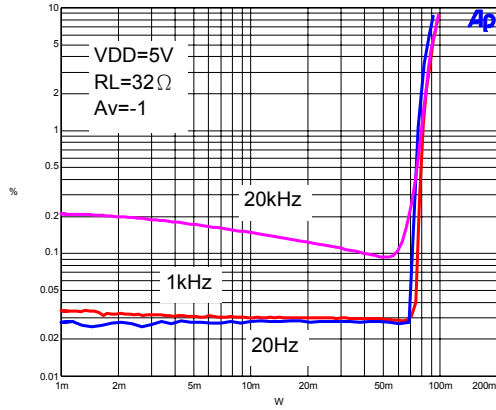

THD+N vs Frequency

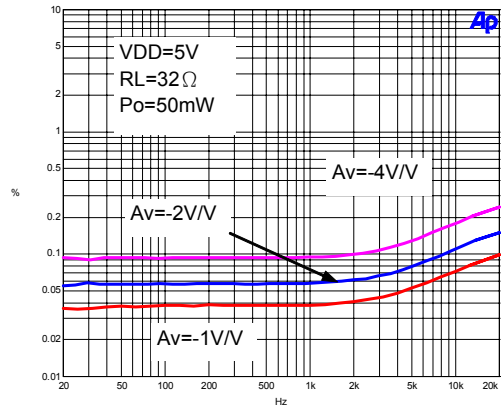

THD+N vs Frequency

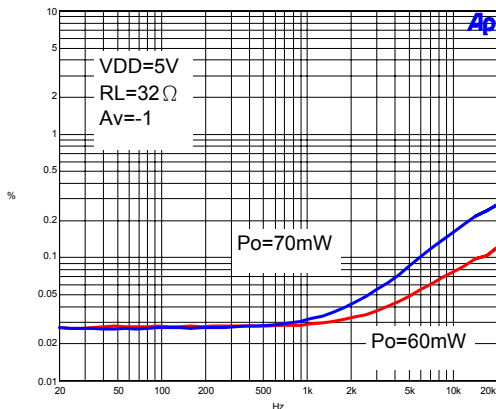

THD+N vs Output Power

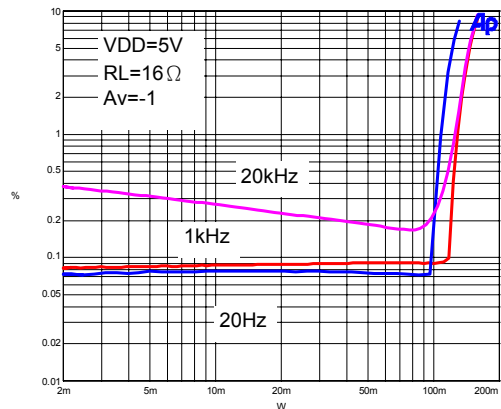

THD+N vs Frequency

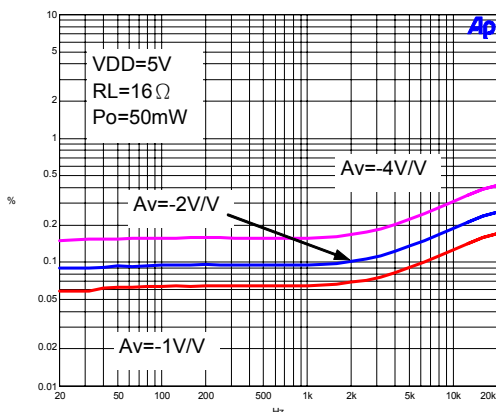

THD+N vs Output Power

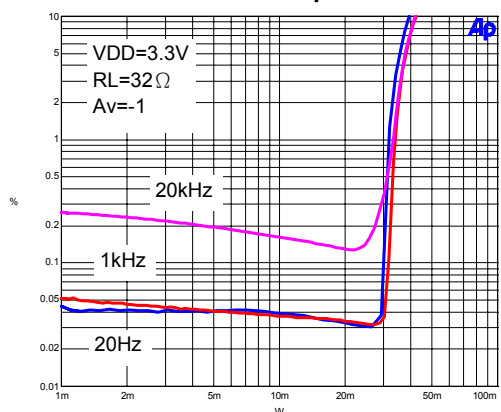



Electrical Characteristics (continued)

THD+N vs Frequency

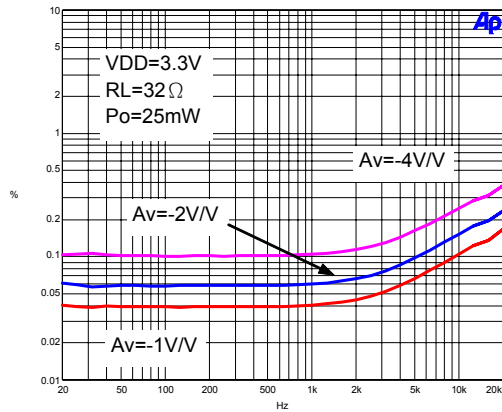

THD+N vs Output Power

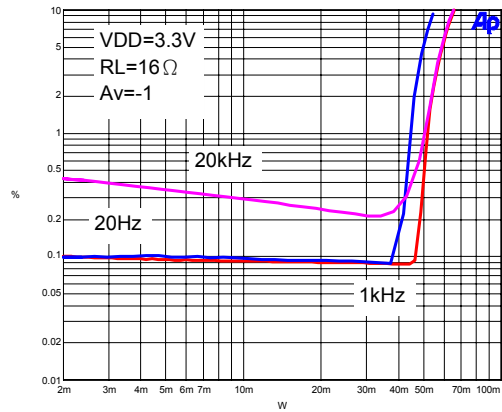

THD+N vs Frequency

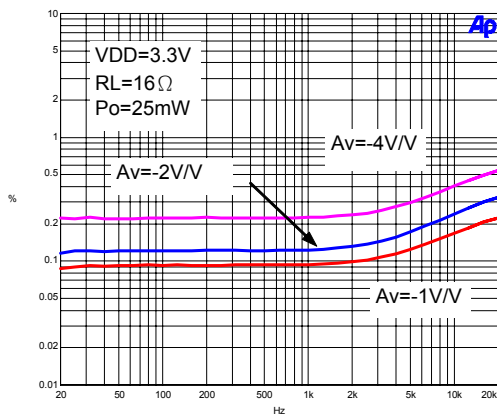

Output Noise

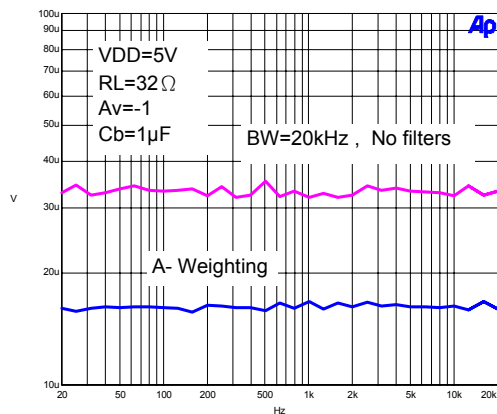

Channel Separation

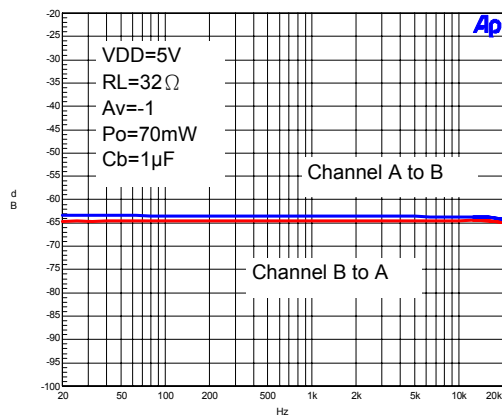

Power Supply Rejection Ratio

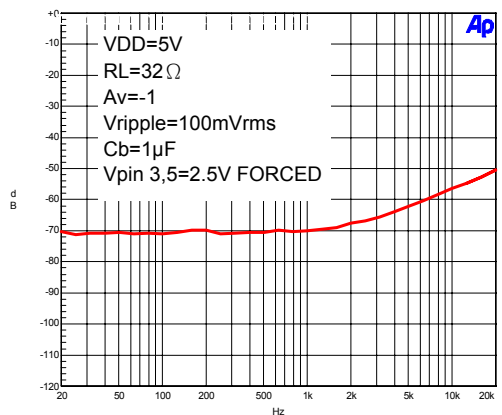



Electrical Characteristics (continued)

Open Loop Frequency Response

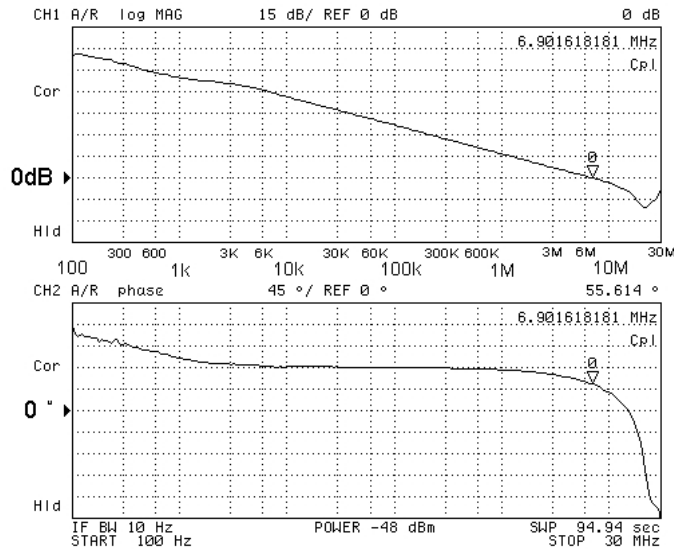

VDD=5V
R_L=5K

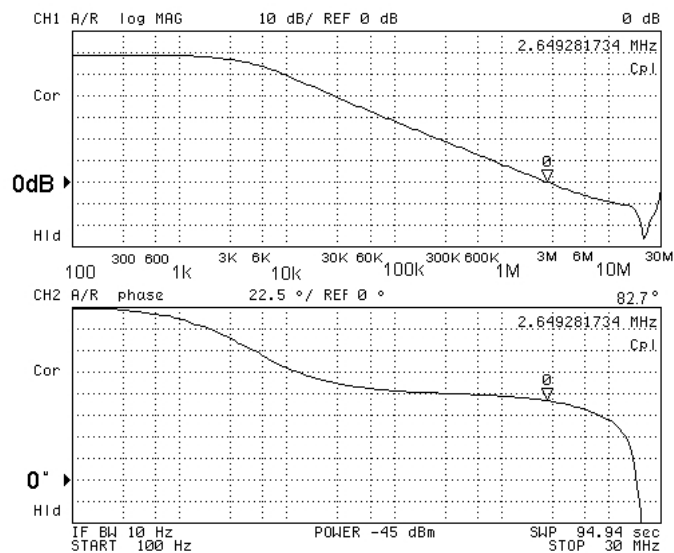

VDD=5V
R_L=32 ohm



Electrical Characteristics (continued)

Supply Current vs. Supply Voltage

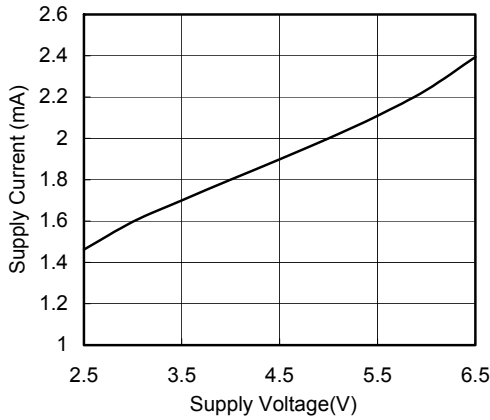

Supply Current vs. Temperature

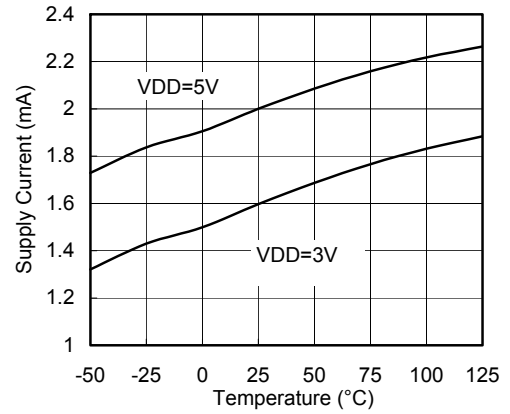

Offset Voltage vs. Supply Voltage

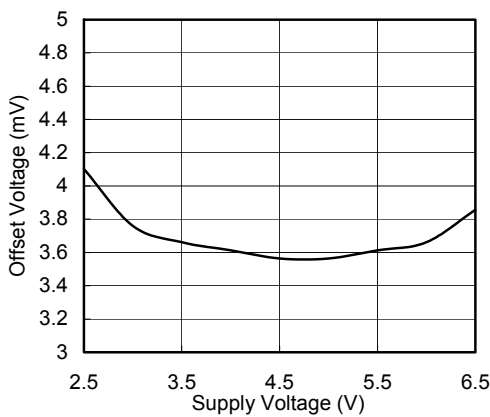

Offset Voltage vs. Temperature

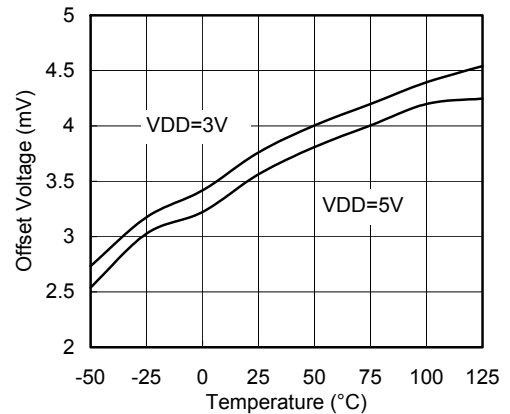

Sinking Current vs. Vo-Vss

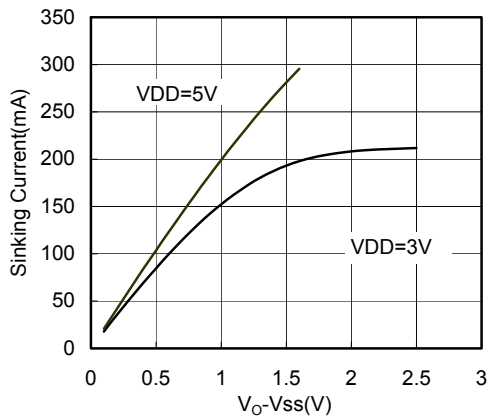

Sourcing Current vs. VDD-Vo

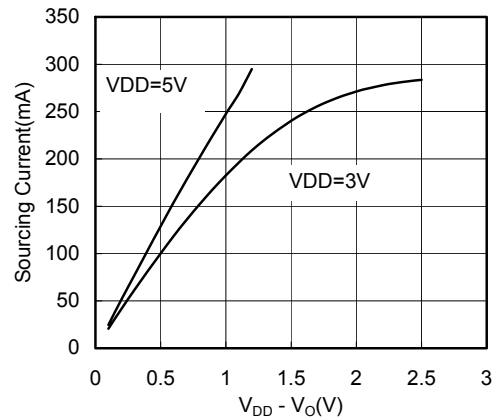



Package Information

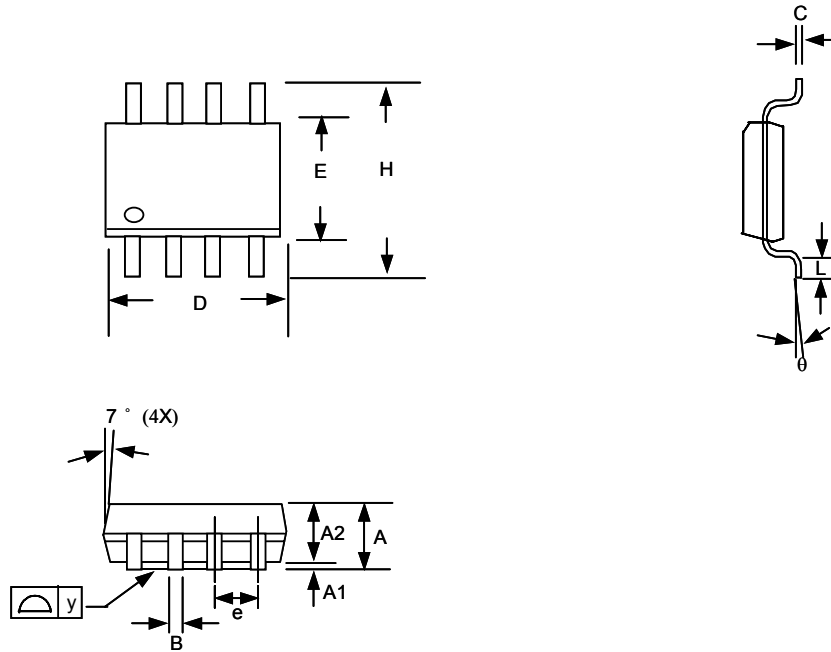

1. Package body sizes exclude mold flash and gate burrs
2. Dimension L is measured in gage plane
3. Tolerance 0.10mm unless otherwise specified
4. Controlling dimension is millimeter converted inch dimensions are not necessarily exact.

SYMBOL	DIMENSION IN MM			DIMENSION IN INCH		
	MIN.	NOM.	MAX.	MIN.	NOM.	MAX.
A	1.35	1.60	1.75	0.053	0.063	0.069
A1	0.10	----	0.25	0.004	----	0.010
A2	----	1.45	----	----	0.057	----
B	0.33	----	0.51	0.013	----	0.020
C	0.19	----	0.25	0.007	----	0.010
D	4.80	----	5.00	0.189	----	0.197
E	3.80	----	4.00	0.150	----	0.157
e	----	1.27	----	----	0.050	----
H	5.80	----	6.20	0.228	----	0.244
L	0.40	----	1.27	0.016	----	0.050
y	----	----	0.10	----	----	0.004
θ	0°	----	8°	0°	----	8°

Taping Specification

