



2W Stereo Audio Amplifier

Features

- Depop Circuitry Integrated
- Output Power at 1% THD+N, VDD=5V
--1.8W/CH (typical) into a 4Ω Load
--1.2W/CH (typical) into a 8Ω Load
- Bridge-Tied Load (BTL), Single-Ended (SE)
- Stereo Input MUX
- Mute and Shutdown Control Available
- Surface-Mount Power Package
24-Pin TSSOP-P

Applications

- Stereo Power Amplifiers for Notebooks or Desktop Computers
- Multimedia Monitors
- Stereo Power Amplifiers for Portable Audio Systems

General Description

G1420 is a stereo audio power amplifier in 24pin TSSOP thermal pad package. It can drive 1.8W continuous RMS power into 4Ω load per channel in Bridge-Tied Load (BTL) mode at 5V supply voltage. Its THD is smaller than 1% under the above operation condition. To simplify the audio system design in the notebook application, G1420 supports the Bridge-Tied Load (BTL) mode for driving the speakers, Single-End (SE) mode for driving the headphone. G1420 can mute the output when Mute-In is activated. For the low current consumption applications, the SHDN mode is supported to disable G1420 when it is idle. The current consumption can be further reduced to below 5μA.

G1420 also supports two input paths, that means two different gain loops can be set in the same PCB and choosing either one by setting HP/LINE pin. It enhances the hardware designing flexibility.

Ordering Information

| ORDER NUMBER | ORDER NUMBER (Pb free) | TEMP. RANGE | PACKAGE |
|--------------|------------------------|----------------|---------------|
| G1420F31U | G1420F31Uf | -40°C to +85°C | TSSOP-24 (FD) |

Note: F3: TSSOP-24 (FD)
U: Tape & Reel

Pin Configuration

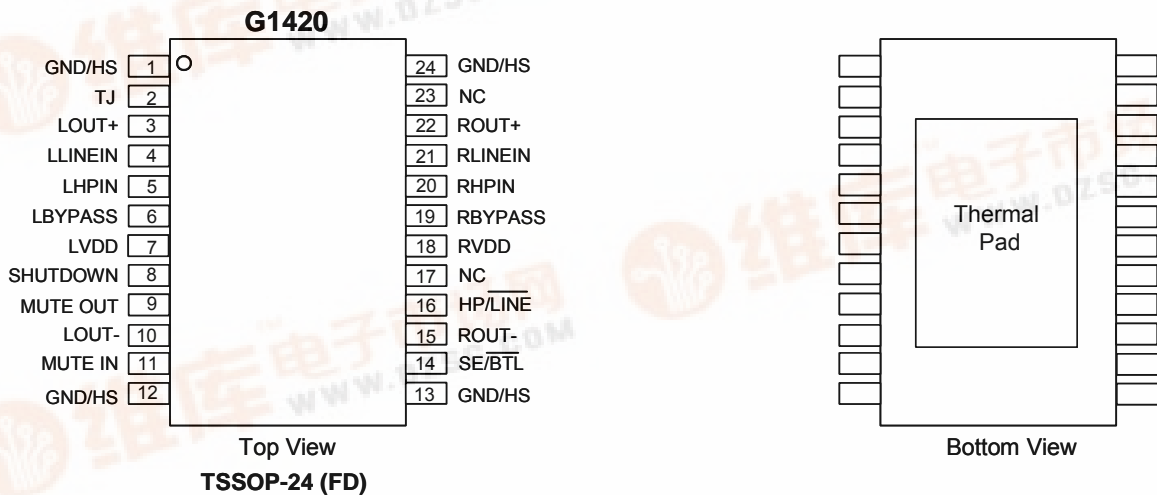

Note: Recommend connecting the Thermal Pad to the GND for excellent power dissipation.



Absolute Maximum Ratings

| | | | |
|--|-----------------|------------------------------------|------------------------------|
| Supply Voltage, V_{CC} | 6V | Power Dissipation ⁽¹⁾ | |
| Operating Ambient Temperature Range | | $T_A \leq 25^\circ\text{C}$ | 2.7W |
| T_A | 40°C to +85°C | $T_A \leq 70^\circ\text{C}$ | 1.7W |
| Maximum Junction Temperature, T_J | 150°C | $T_A \leq 85^\circ\text{C}$ | 1.4W |
| Storage Temperature Range, T_{STG} | -65°C to +150°C | Electrostatic Discharge, V_{ESD} | |
| Reflow Temperature (soldering, 10sec)..... | 260°C | Human body mode..... | -3000 to 3000 ⁽²⁾ |

Note:

⁽¹⁾: Recommended PCB Layout

⁽²⁾: Human body model : C = 100pF, R = 1500Ω, 3 positive pulses plus 3 negative pulses

Electrical Characteristics

DC Electrical Characteristics, $T_A=+25^\circ\text{C}$

| PARAMETER | SYMBOL | CONDITIONS | MIN | TYP | MAX | UNIT | |
|--------------------------------|----------------|---------------------------------------|------------|-----|-----|------|----|
| Supply Current | I_{DD} | $V_{DD} = 3.3\text{V}$ | Stereo BTL | --- | 7 | 13 | mA |
| | | | Stereo SE | --- | 3.5 | 8 | |
| | | $V_{DD} = 5\text{V}$ | Stereo BTL | --- | 8 | 16 | |
| | | | Stereo SE | --- | 4 | 10 | |
| DC Differential Output Voltage | $V_{O(DIFF)}$ | $V_{DD} = 5\text{V}, \text{Gain} = 2$ | --- | 5 | 50 | mV | |
| Supply Current in Mute Mode | $I_{DD(MUTE)}$ | $V_{DD} = 5\text{V}$ | Stereo BTL | --- | 8 | 16 | mA |
| | | | Stereo SE | --- | 4 | 10 | |
| I_{DD} in Shutdown | I_{SD} | $V_{DD} = 5\text{V}$ | --- | 2 | 5 | μA | |

(AC Operation Characteristics, $V_{DD} = 5.0\text{V}$, $T_A=+25^\circ\text{C}$, $R_L = 4\Omega$, unless otherwise noted)

| PARAMETER | SYMBOL | CONDITIONS | MIN | TYP | MAX | UNIT |
|--------------------------------------|-------------|--|--------------------------------|------|-----|----------|
| Output power (each channel) see Note | $P_{(OUT)}$ | THD = 1%, BTL, $R_L = 4\Omega$ | --- | 1.8 | --- | W |
| | | THD = 1%, BTL, $R_L = 8\Omega$ | --- | 1.12 | --- | |
| | | THD = 10%, BTL, $R_L = 4\Omega$ | --- | 2 | --- | |
| | | THD = 10%, BTL, $R_L = 8\Omega$ | --- | 1.4 | --- | |
| | | mW | THD = 1%, SE, $R_L = 4\Omega$ | --- | 500 | --- |
| | | | THD = 1%, SE, $R_L = 8\Omega$ | --- | 320 | --- |
| | | | THD = 10%, SE, $R_L = 4\Omega$ | --- | 650 | --- |
| | | | THD = 10%, SE, $R_L = 8\Omega$ | --- | 400 | --- |
| Total harmonic distortion plus noise | THD+N | $P_O = 1.6\text{W}$, BTL, $R_L = 4\Omega$ | --- | 500 | --- | m% |
| | | $P_O = 1\text{W}$, BTL, $R_L = 8\Omega$ | --- | 150 | --- | |
| | | $P_O = 75\text{mW}$, SE, $R_L = 32\Omega$ | --- | 20 | --- | |
| | | $V_I = 1\text{V}$, $R_L = 10\text{K}\Omega$, $G = 1$ | --- | 10 | --- | |
| Maximum output power bandwidth | B_{OM} | $G = 1$, THD = 1% | --- | 20 | --- | kHz |
| Phase margin | | $R_L = 4\Omega$, Open Load | --- | 60 | --- | ° |
| Power supply ripple rejection | PSRR | $f = 120\text{Hz}$ | --- | 75 | --- | dB |
| Mute attenuation | | | --- | 85 | --- | dB |
| Channel-to-channel output separation | | $f = 1\text{kHz}$ | --- | 82 | --- | dB |
| Line/HP input separation | | | --- | 80 | --- | dB |
| BTL attenuation in SE mode | | | --- | 85 | --- | dB |
| Input impedance | ZI | | --- | 2 | --- | MΩ |
| Signal-to-noise ratio | | $P_O = 500\text{mW}$, BTL | --- | 90 | --- | dB |
| Output noise voltage | V_n | Output noise voltage | --- | 55 | --- | μV (rms) |

Note :Output power is measured at the output terminals of the IC at 1kHz.



(AC Operation Characteristics, $V_{DD} = 3.3V$, $T_A = +25^\circ C$, $R_L = 4\Omega$, unless otherwise noted)

| PARAMETER | SYMBOL | CONDITIONS | MIN | TYP | MAX | UNIT |
|--------------------------------------|-------------|--|--------------------------------|-----|-----|----------|
| Output power (each channel) see Note | $P_{(OUT)}$ | THD = 1%, BTL, $R_L = 4\Omega$ | --- | 0.8 | --- | W |
| | | THD = 1%, BTL, $R_L = 8\Omega$ | --- | 0.5 | --- | |
| | | THD = 10%, BTL, $R_L = 4\Omega$ | --- | 1 | --- | |
| | | THD = 10%, BTL, $R_L = 8\Omega$ | --- | 0.6 | --- | |
| | | mW | THD = 1%, SE, $R_L = 4\Omega$ | --- | 230 | --- |
| | | | THD = 1%, SE, $R_L = 8\Omega$ | --- | 140 | --- |
| | | | THD = 10%, SE, $R_L = 4\Omega$ | --- | 290 | --- |
| | | | THD = 10%, SE, $R_L = 8\Omega$ | --- | 180 | --- |
| Total harmonic distortion plus noise | THD+N | THD = 0.5%, SE, $R_L = 32\Omega$ | --- | 43 | --- | m% |
| | | $P_O = 1.6W$, BTL, $R_L = 4\Omega$ | --- | 270 | --- | |
| | | $P_O = 1W$, BTL, $R_L = 8\Omega$ | --- | 100 | --- | |
| | | $P_O = 75mW$, SE, $R_L = 32\Omega$ | --- | 20 | --- | |
| Maximum output power bandwidth | B_{OM} | $V_I = 1V$, $R_L = 10K\Omega$, $G = 1$ | --- | 10 | --- | kHz |
| Phase margin | | $G = 1$, THD 1% | --- | 20 | --- | ° |
| Power supply ripple rejection | PSRR | $R_L = 4\Omega$, Open Load | --- | 60 | --- | dB |
| Mute attenuation | | $f = 120Hz$ | --- | 75 | --- | dB |
| Channel-to-channel output separation | | | --- | 85 | --- | dB |
| Line/HP input separation | | $f = 1kHz$ | --- | 80 | --- | dB |
| BTL attenuation in SE mode | | | --- | 80 | --- | dB |
| Input impedance | ZI | | --- | 85 | --- | dB |
| Signal-to-noise ratio | | | --- | 2 | --- | MΩ |
| Output noise voltage | V_n | $P_O = 500mW$, BTL | --- | 90 | --- | dB |
| | | Output noise voltage | --- | 55 | --- | μV (rms) |

Note :Output power is measured at the output terminals of the IC at 1kHz.



Typical Characteristics

Table of Graphs

| | | FIGURE | |
|---|-------------------------------|---|-------------|
| THD +N Total Harmonic Distortion Plus Noise | vs Output Power | 1,3,6,9,10,13,16,19,22,25,28,31 | |
| | vs Frequency | 2,4,5,7,8,11,12,14,15,17,18,20,21,23,24,26,27,29,30,32,33 | |
| V _n | Output Noise Voltage | vs Frequency | 34,35 |
| | Supply Ripple Rejection Ratio | vs Frequency | 36,37 |
| | Crosstalk | vs Frequency | 38,39,40,41 |
| | Closed Loop Response | vs Frequency | 42,43,44,45 |
| I _{DD} | Supply Current | vs Supply Voltage | 46 |
| P _O | Output Power | vs Load Resistance | 47,48 |
| | | vs Load Resistance | 49,50 |
| P _D | Power Dissipation | vs Output Power | 51,52,53,54 |

Total Harmonic Distortion Plus Noise vs Output Power

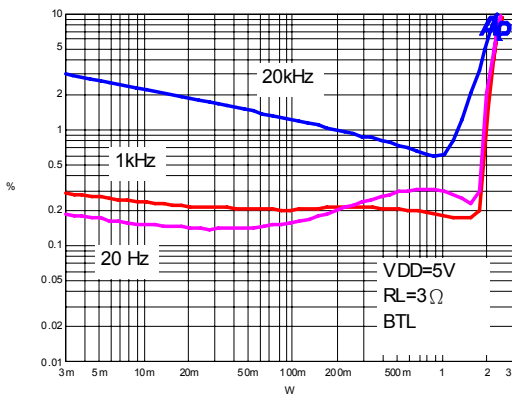

Figure 1

Total Harmonic Distortion Plus Noise vs Output Frequency

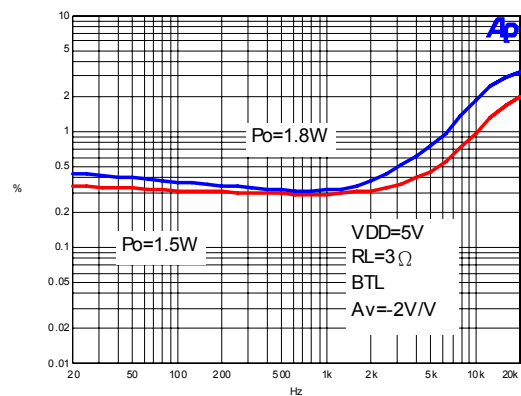

Figure 2

Total Harmonic Distortion Plus Noise vs Output Power

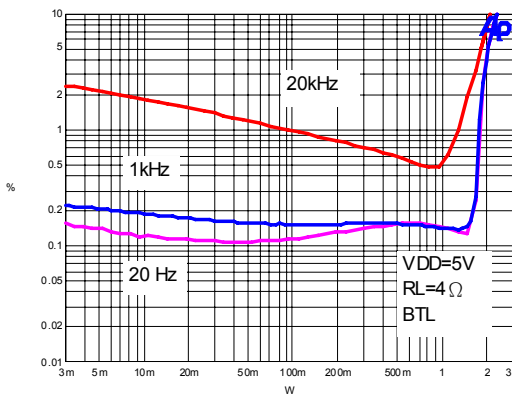

Figure 3

Total Harmonic Distortion Plus Noise vs Output Frequency

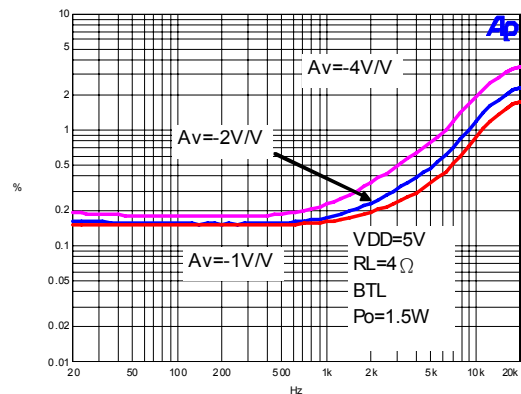

Figure 4

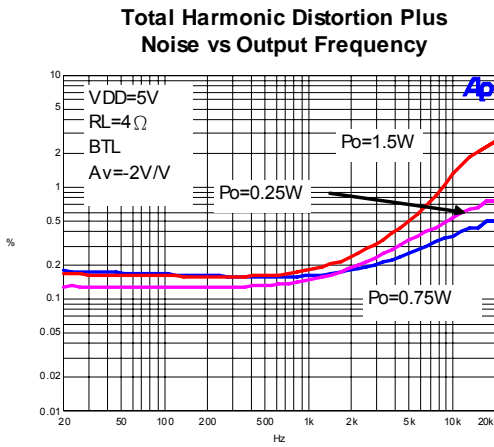

Figure 5

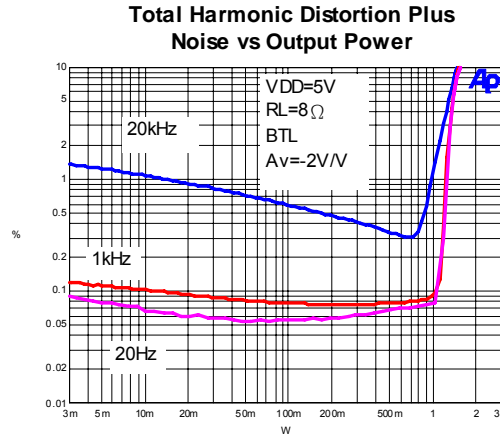

Figure 6

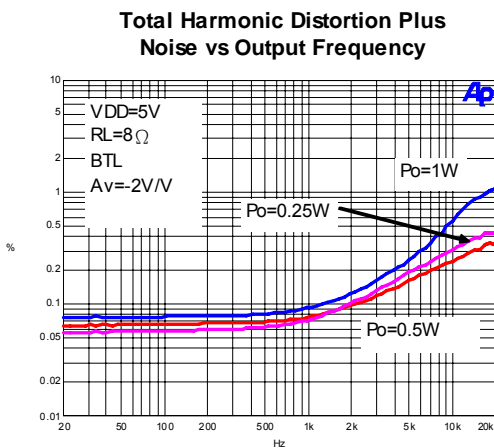

Figure 7

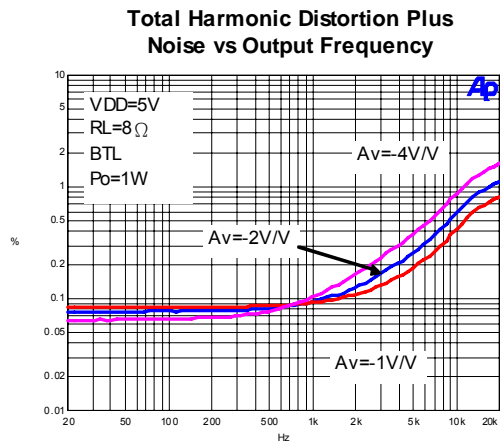

Figure 8

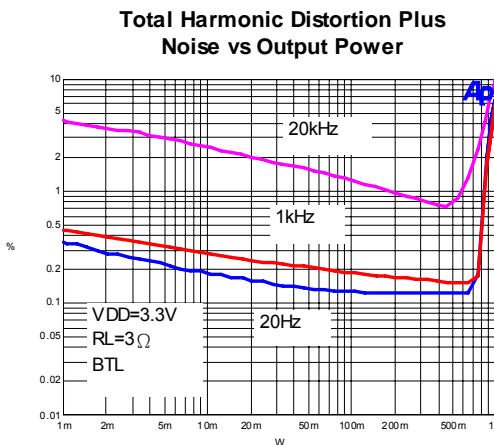

Figure 9

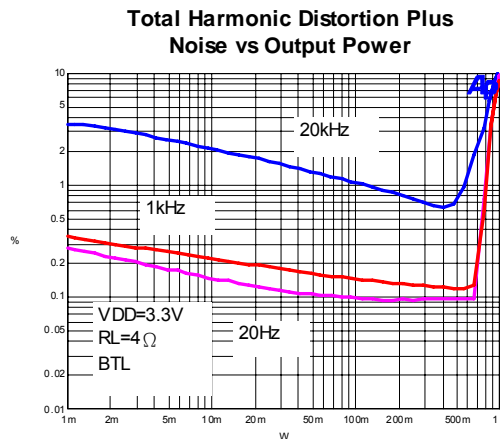

Figure 10

Total Harmonic Distortion Plus Noise vs Output Frequency

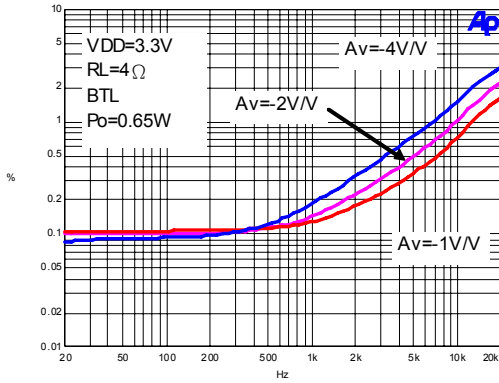

Figure 11

Total Harmonic Distortion Plus Noise vs Output Frequency

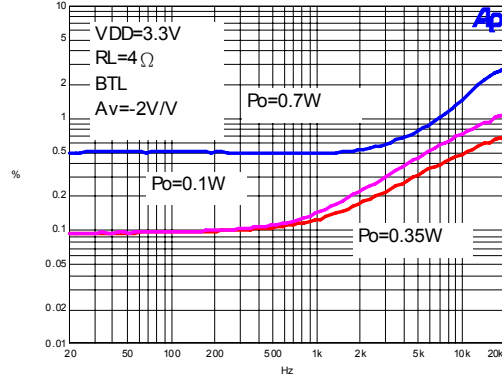

Figure 12

Total Harmonic Distortion Plus Noise vs Output Power

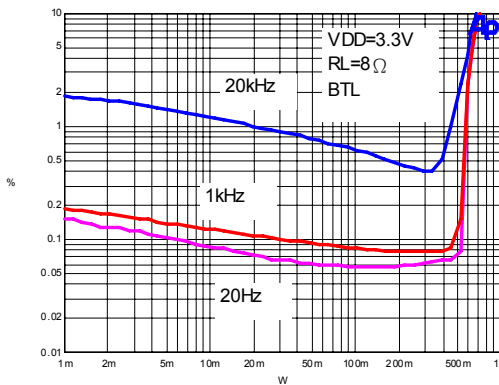

Figure 13

Total Harmonic Distortion Plus Noise vs Output Frequency

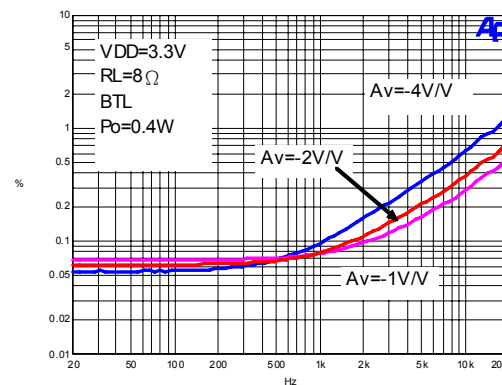

Figure 14

Total Harmonic Distortion Plus Noise vs Output Frequency

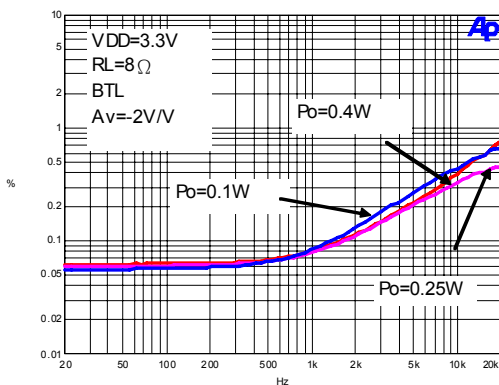

Figure 15

Total Harmonic Distortion Plus Noise vs Output Power

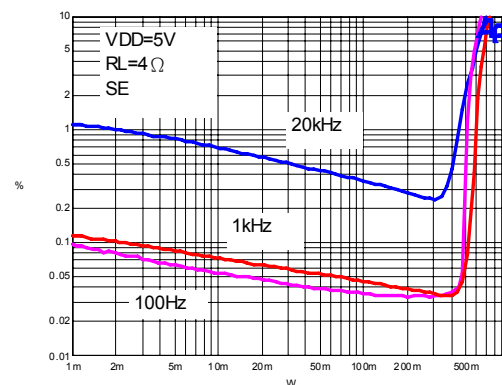

Figure 16

Total Harmonic Distortion Plus Noise vs Output Frequency

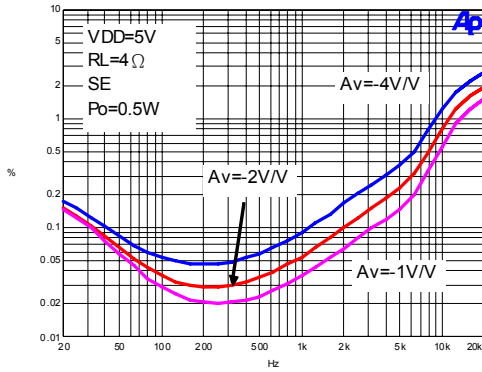

Figure 17

Total Harmonic Distortion Plus Noise vs Output Frequency

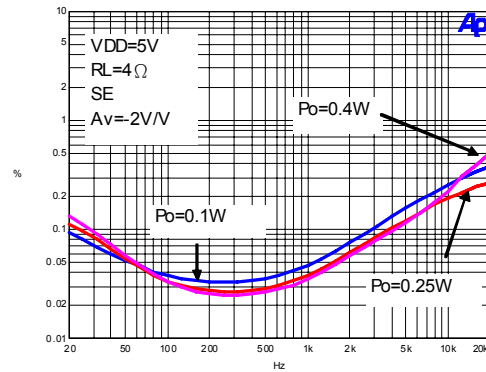

Figure 18

Total Harmonic Distortion Plus Noise vs Output Power

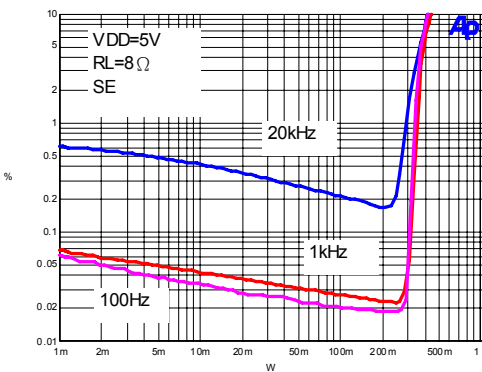

Figure 19

Total Harmonic Distortion Plus Noise vs Output Frequency

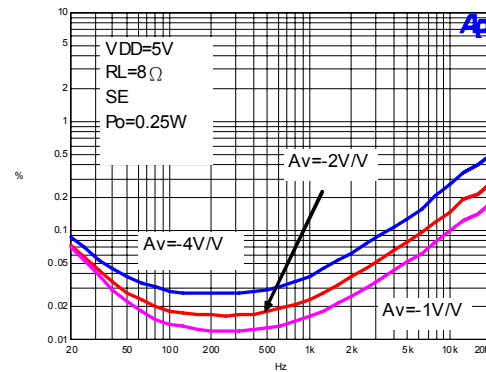

Figure 20

Total Harmonic Distortion Plus Noise vs Output Frequency

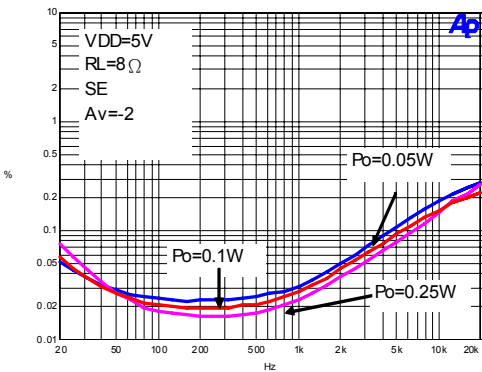

Figure 21

Total Harmonic Distortion Plus Noise vs Output Power

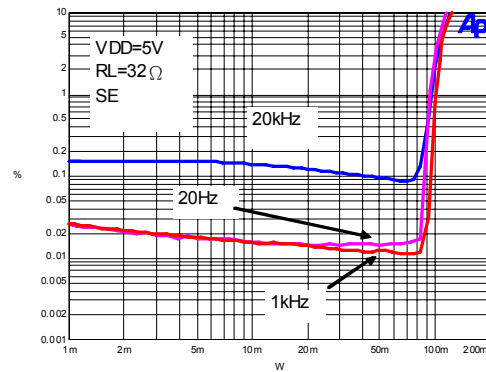

Figure 22

Total Harmonic Distortion Plus Noise vs Output Frequency

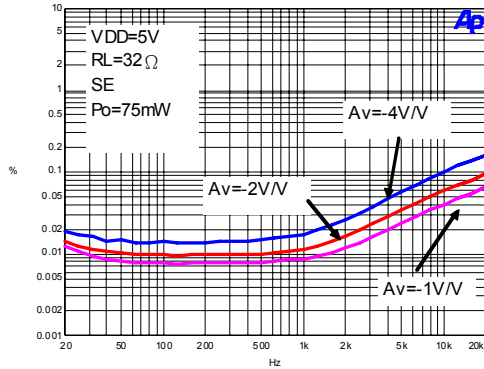

Figure 23

Total Harmonic Distortion Plus Noise vs Output Frequency

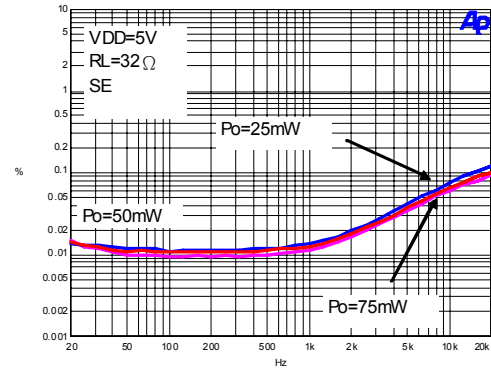

Figure 24

Total Harmonic Distortion Plus Noise vs Output Power

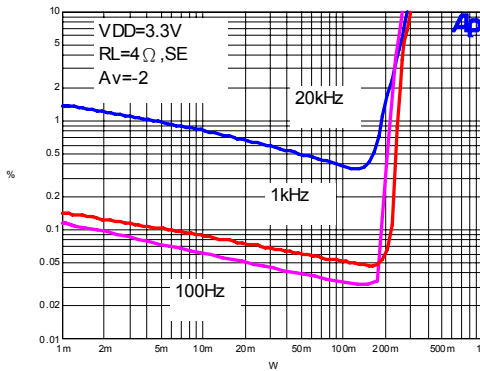

Figure 25

Total Harmonic Distortion Plus Noise vs Output Frequency

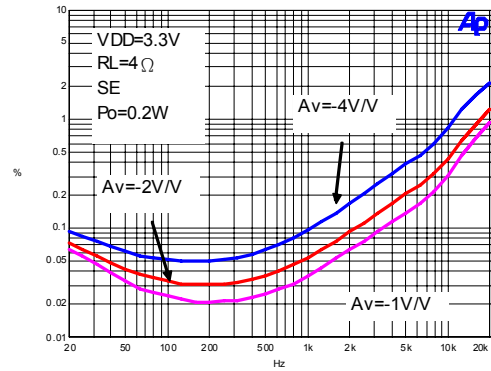

Figure 26

Total Harmonic Distortion Plus Noise vs Output Frequency

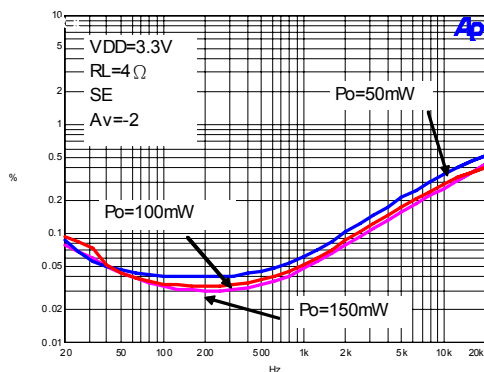

Figure 27

Total Harmonic Distortion Plus Noise vs Output Power

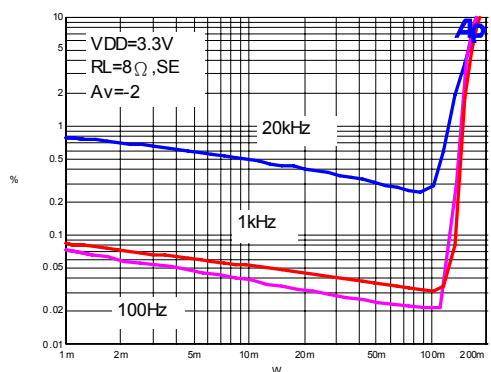

Figure 28

Total Harmonic Distortion Plus Noise vs Output Frequency

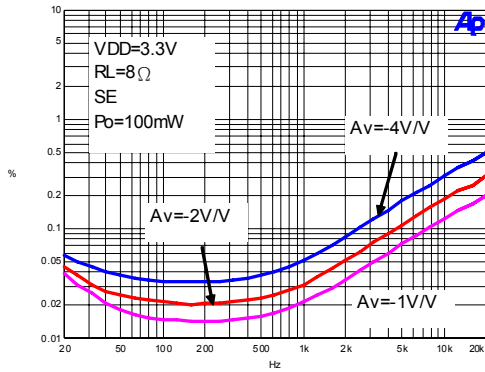

Figure 29

Total Harmonic Distortion Plus Noise vs Output Frequency

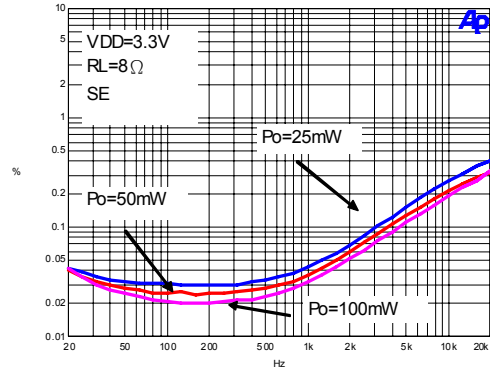

Figure 30

Total Harmonic Distortion Plus Noise vs Output Power

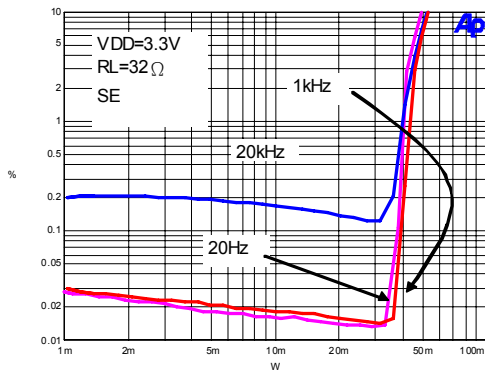

Figure 31

Total Harmonic Distortion Plus Noise vs Output Frequency

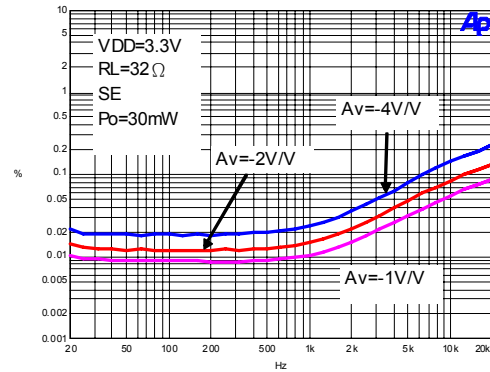

Figure 32

Total Harmonic Distortion Plus Noise vs Output Frequency

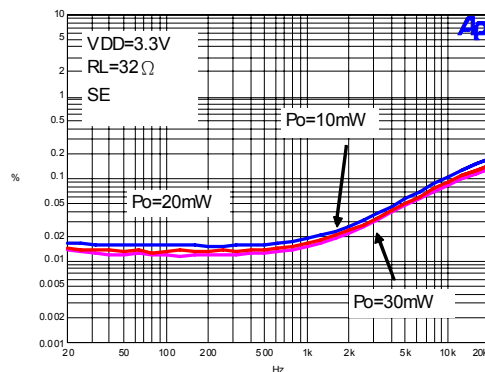

Figure 33

Output Noise Voltage vs Frequency

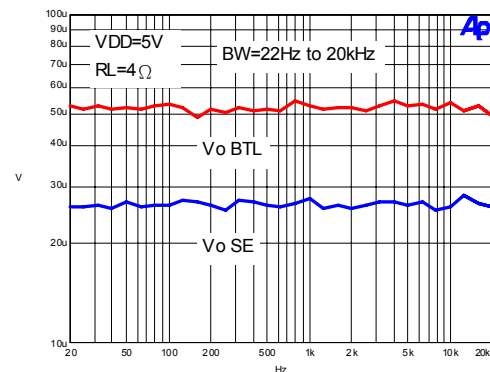

Figure 34



Output Noise Voltage vs Frequency

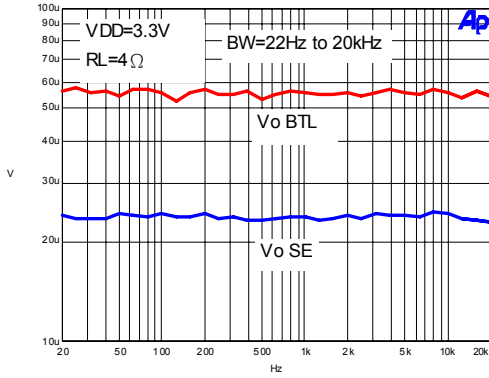

Figure 35

Supply Ripple Rejection Ratio vs Frequency

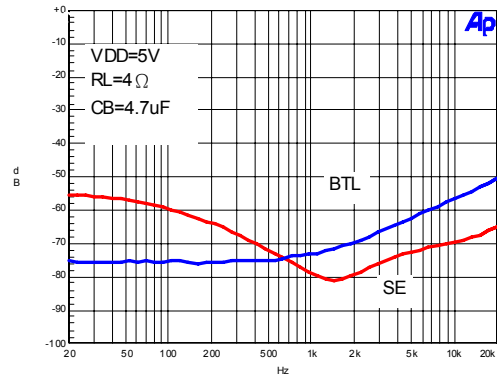

Figure 36

Supply Ripple Rejection Ratio vs Frequency

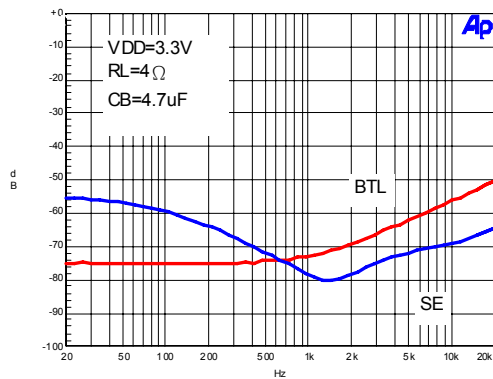

Figure 37

Crosstalk vs Frequency

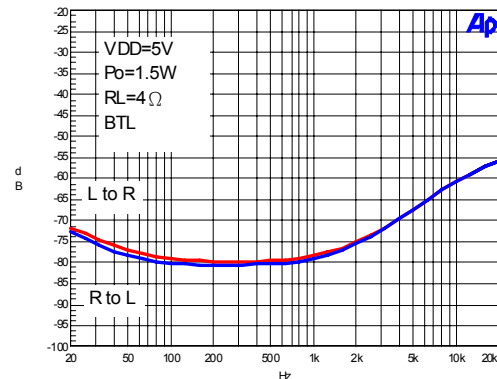

Figure 38

Crosstalk vs Frequency

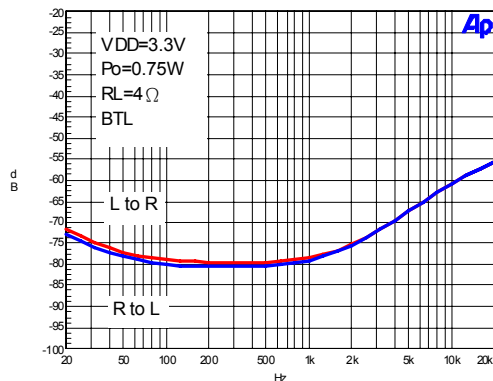

Figure 39

Crosstalk vs Frequency

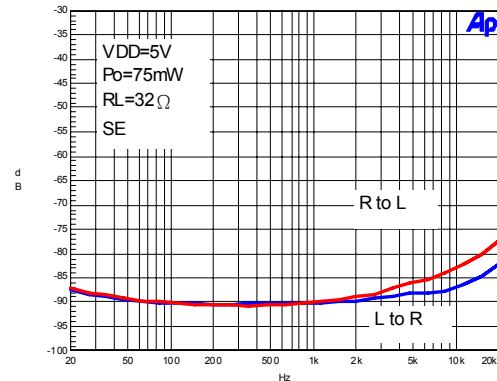

Figure 40

Crosstalk vs Frequency

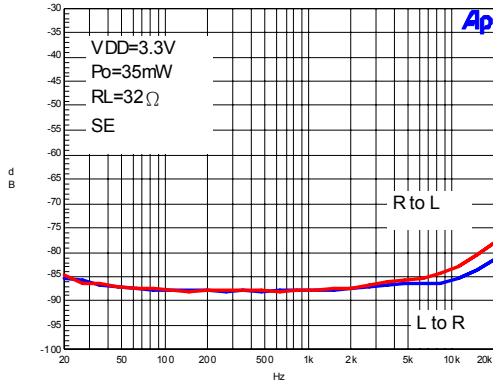

Figure 41

Closed Loop Response

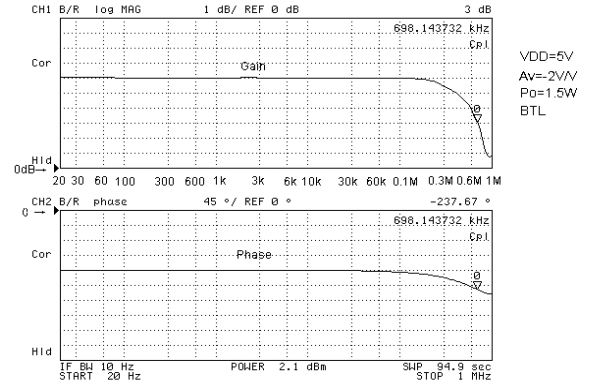

Figure 42

Closed Loop Response

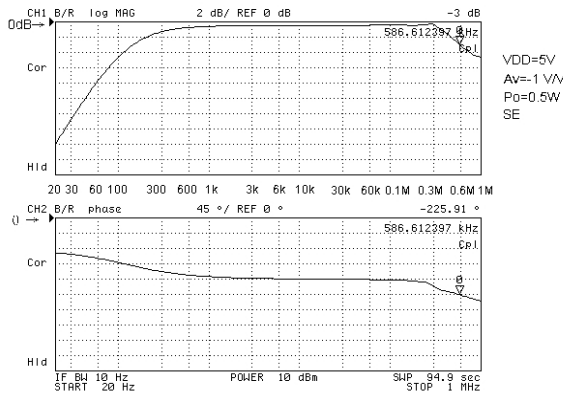

Figure 43

Closed Loop Response

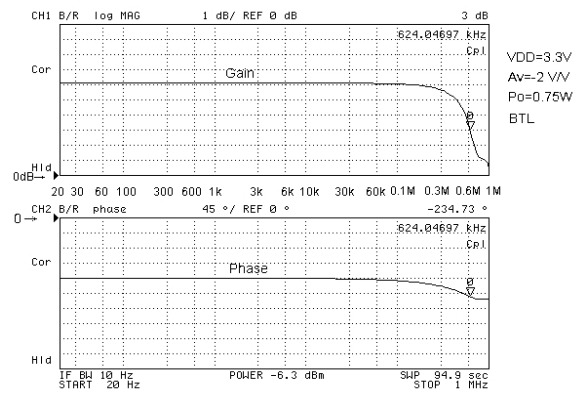

Figure 44

Closed Loop Response

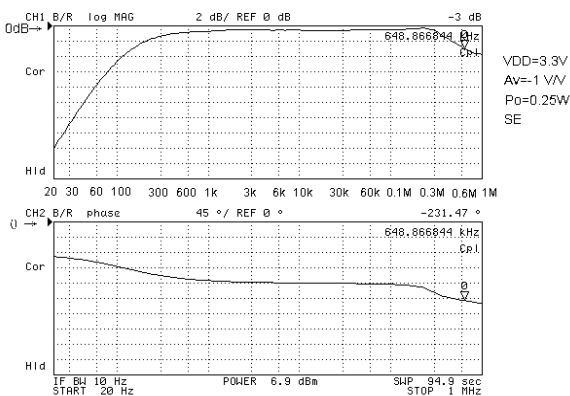

Figure 45

Supply Current vs Supply Voltage

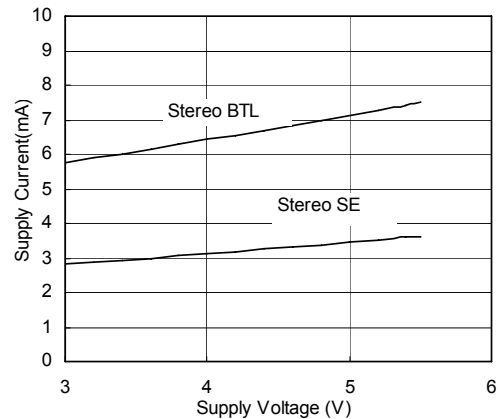

Figure 46

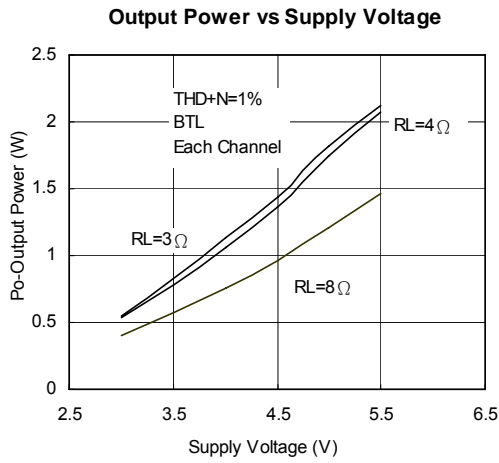

Figure 47

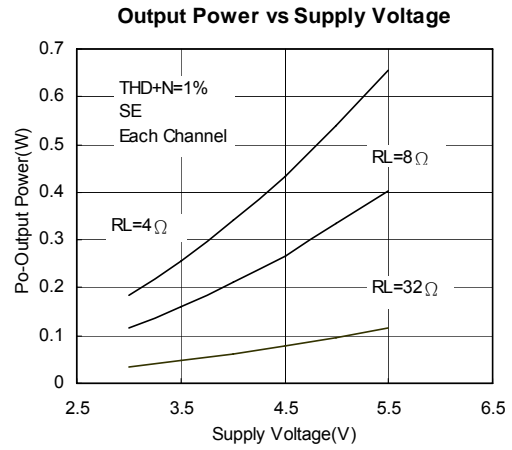

Figure 48

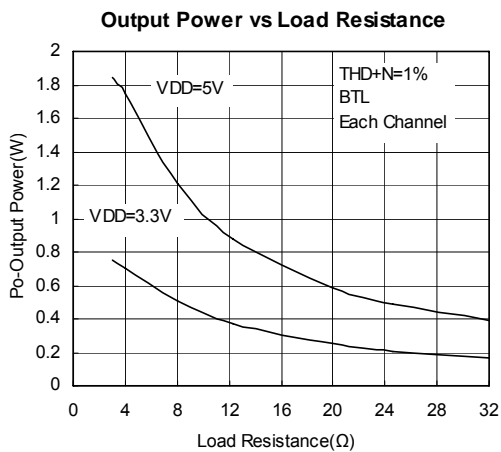

Figure 49

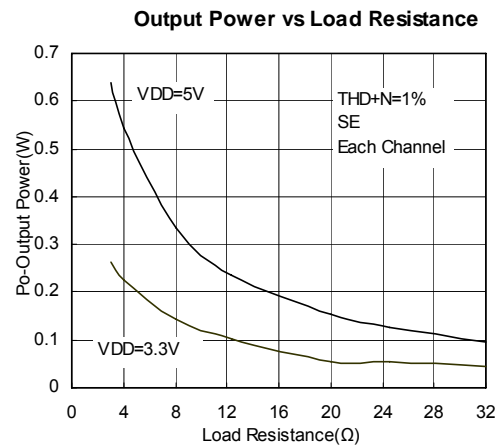

Figure 50

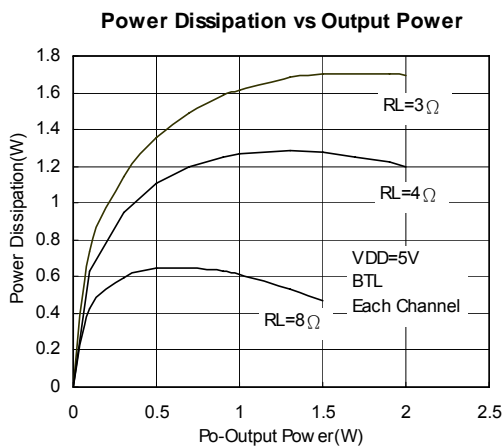

Figure 51

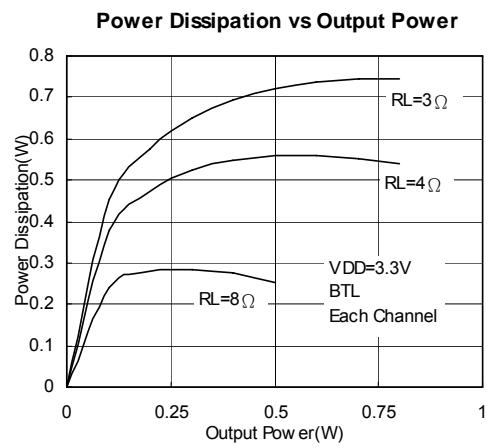
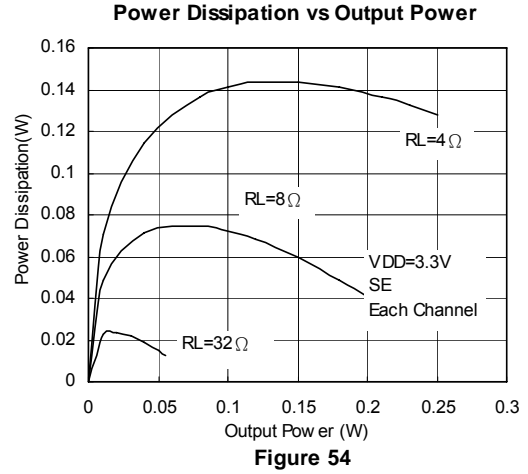
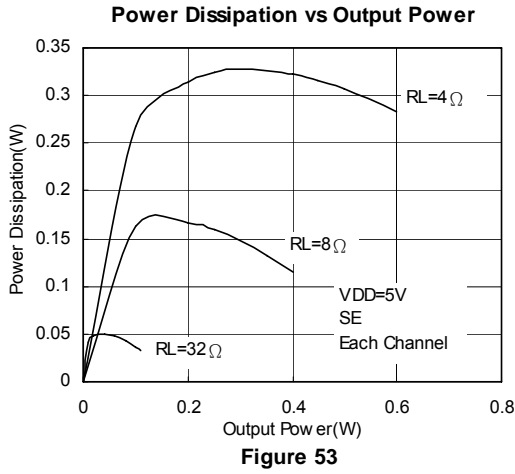
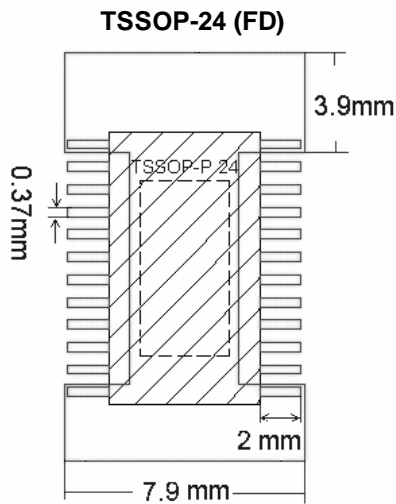

Figure 52



Recommended Minimum Footprint





Pin Description

| PIN | NAME | I/O | FUNCTION |
|-------------|----------|-----|---|
| 1,12,13,24 | GND/HS | | Ground connection for circuitry, directly connected to thermal pad. |
| 2 | TJ | O | Source a current inversely to the junction temperature. This pin should be left unconnected during normal operation. For more information, see the junction temperature measurement section of this document. |
| 3 | LOUT+ | O | Left channel + output in BTL mode, + output in SE mode. |
| 4 | LLINE IN | I | Left channel line input, selected when HP/ pin is held low. |
| 5 | LHP IN | I | Left channel headphone input, selected when HP/pin is held high. |
| 6 | LBYPASS | | Connect to voltage divider for left channel internal mid-supply bias. |
| 7 | LVDD | I | Supply voltage input for left channel and for primary bias circuits. |
| 8 | SHUTDOWN | I | Shutdown mode control signal input, places entire IC in shutdown mode when held high, $I_{DD} = 5\mu A$. |
| 9 | MUTE OUT | O | Follows MUTE IN pin, provides buffered output. |
| 10 | LOUT- | O | Left channel - output in BTL mode, high impedance state in SE mode. |
| 11 | MUTE IN | I | Mute control signal input, hold low for normal operation, hold high to mute. |
| 14 | SE/BTL | I | Mode control signal input, hold low for BTL mode, hold high for SE mode. |
| 15 | ROUT- | O | Right channel - output in BTL mode, high impedance state in SE mode. |
| 16 | HP/LINE | I | MUX control input, hold high to select headphone inputs (5,20), hold low to select line inputs (4,21). |
| 17,23 | NC | | |
| 18 | RVDD | I | Supply voltage input for right channel. |
| 19 | RBYPASS | | Connect to voltage divider for right channel internal mid-supply bias. |
| 20 | RHP IN | I | Right channel headphone input, selected when HP/pin is held high. |
| 21 | RLINE IN | I | Right channel line input, selected when HP/pin is held low. |
| 22 | ROUT+ | O | Right channel + output in BTL mode, + output in SE mode. |
| Thermal Pad | | | Recommend connecting the Thermal Pad to the GND for excellent power dissipation. |

Block Diagram

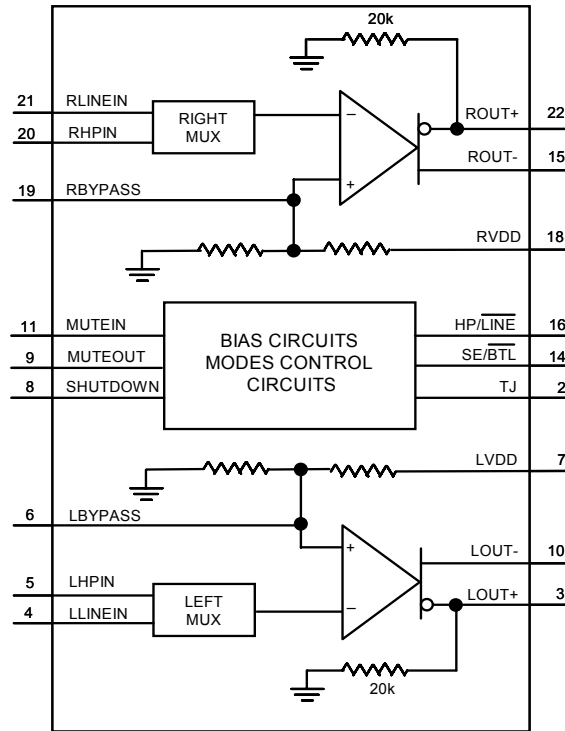

Parameter Measurement Information

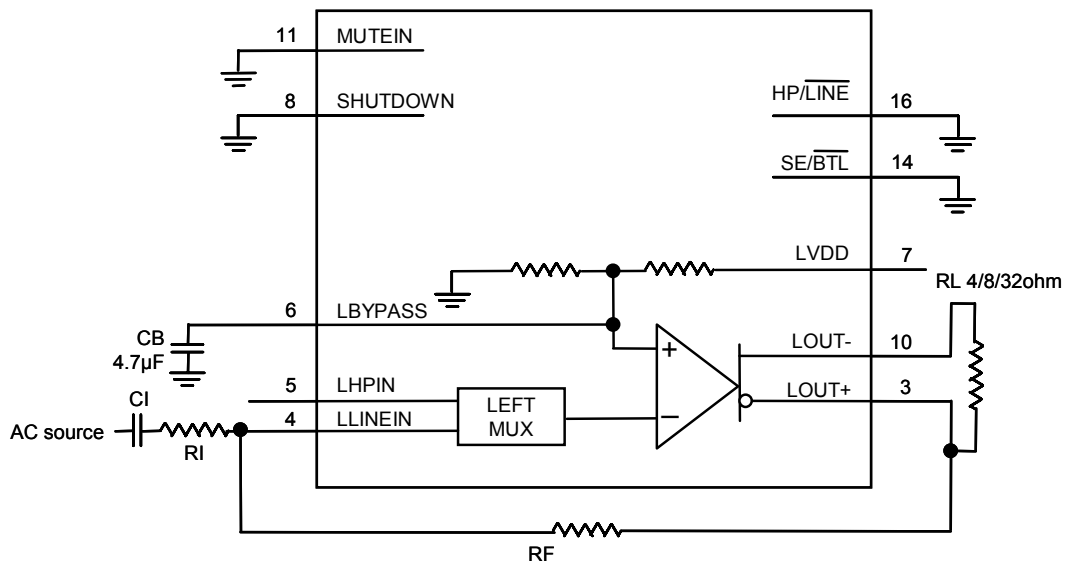

BTL Mode Test Circuit

Parameter Measurement Information (Continued)

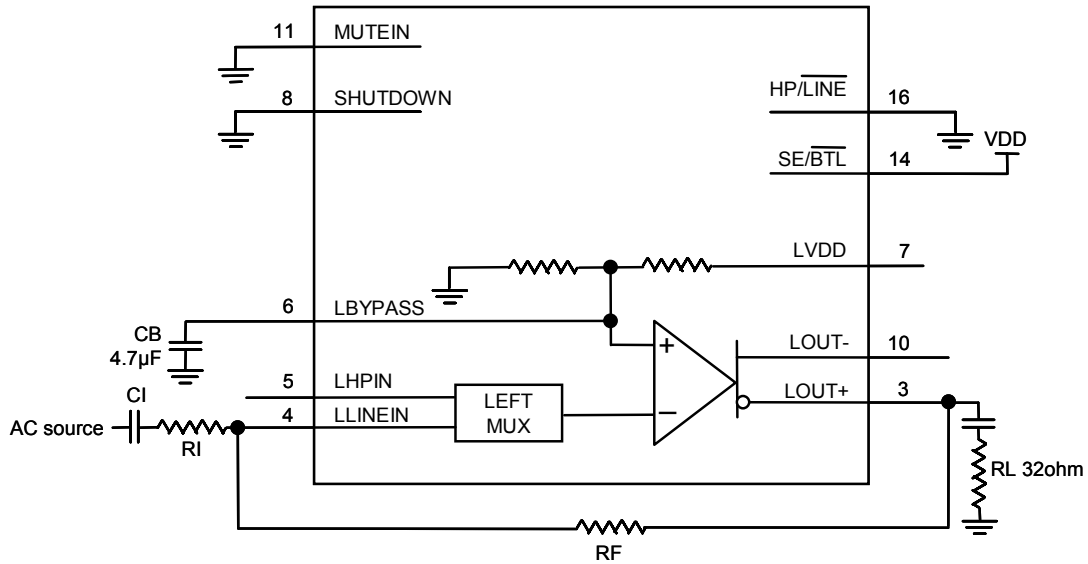

SE Mode Test Circuit

Application Information

Input MUX Operation

There are two input signal paths – HP & Line. With the prompt setting, G1420 allows the setting of different gains for BTL and SE modes. Generally, speakers typically require approximately a factor of 10 more gain for similar volume listening levels as compared with headphones.

$$SE\ Gain_{(HP)} = -(R_{F(HP)}/R_{I(HP)})$$

$$BTL\ Gain_{(LINE)} = -2(R_{F(LINE)}/R_{I(LINE)})$$

To achieve headphones and speakers listening parity, $(R_{F(LINE)}/R_{I(LINE)})$ is suggested to be 5 times of $(R_{F(HP)}/R_{I(HP)})$. The ratio of $(R_{F(HP)}/R_{I(HP)})$ can be determined by the applications. When the optimum distortion performance into the headphones (clear sound) is important, gain of -1 ($(R_{F(HP)}/R_{I(HP)}) = 1$) is suggested.

Single Ended Mode Operation

G1420 can drive clean, low distortion SE output power into headphone loads (generally 16Ω or 32Ω) as in Figure A. Please refer to **Electrical Characteristics** to see the performances. A coupling capacitor is needed to block the dc offset voltage, allowing pure ac signals into headphone loads. Choosing the coupling capacitor will also determine the 3 dB point of the high-pass filter network, as Figure B.

$$f_c = 1/(2\pi R_L C_C)$$

For example, a $68\mu F$ capacitor with 32Ω headphone load would attenuate low frequency performance below 73Hz. So the coupling capacitor should be well chosen to achieve the excellent bass performance when in SE mode operation.

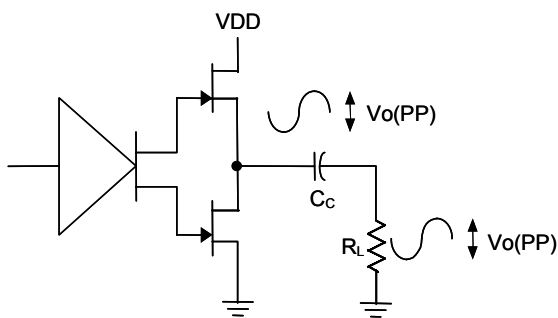

Figure A

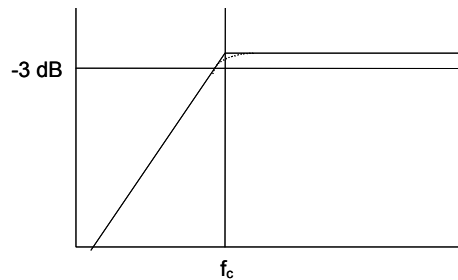

Figure B

Bridged-Tied Load Mode Operation

G1420 has two linear amplifiers to drive both ends of the speaker load in Bridged-Tied Load (BTL) mode operation. Figure C shows the BTL configuration. The differential driving to the speaker load means that when one side is slewing up, the other side is slewing down, and vice versa. This configuration in effect will double the voltage swing on the load as compared to a ground reference load. In BTL mode, the peak-to-peak voltage $V_o(PP)$ on the load will be two times than a ground reference configuration. The voltage on the load is doubled, this will also yield 4 times output power on the load at the same power supply rail and loading. Another benefit of using differential driving configuration is that BTL operation cancels the dc offsets, which eliminates the dc coupling capacitor that is needed to cancelled dc offsets in the ground reference configuration. Low-frequency performance is then limited only by the input network and speaker responses. Cost and PCB space can be minimized by eliminating the dc coupling capacitors.

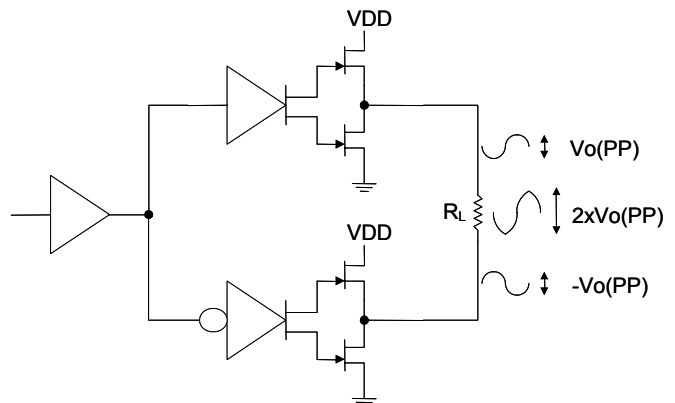

Figure C

MUTE and SHUTDOWN Mode Operations

G1420 implements the mute and shutdown mode operations to reduce supply current, I_{DD} , to the absolute minimum level during nonuse periods for battery-power conservation. When the shutdown pin (pin 8) is pulled high, all linear amplifiers will be deactivated to mute the amplifier outputs. And G1420 enters an extra low current consumption state, I_{DD} is smaller than $5\mu A$. If pulling mute-in pin (pin 11) high, it will force the activated linear amplifier to supply the $V_{DD}/2$ dc voltage on the output to mute the AC performance. In mute mode operation, the current consumption will be a little different between BTL, SE. (SE < BTL) Typically, the supply current is about 2.5mA in BTL mute operation. Shutdown and Mute-In pins should never be left unconnected, this floating condition will cause the amplifier operations unpredictable.

Optimizing DEPOP Operation

Circuitry has been implemented in G1420 to minimize the amount of popping heard at power-up and when coming out of shutdown mode. Popping occurs whenever a voltage step is applied to the speaker and making the differential voltage generated at the two ends of the speaker. To avoid the popping heard, the bypass capacitor should be chosen promptly, $1/(C_B \times 100k\Omega) \leq 1/(C_i \times (R_i + R_F))$. Where $100k\Omega$ is the output impedance of the mid-rail generator, C_B is the mid-rail bypass capacitor, C_i is the input coupling capacitor, R_i is the input impedance, R_F is the gain setting impedance which is on the feedback path. C_B is the most important capacitor. Besides it is used to reduce the popping, C_B can also determine the rate at which the amplifier starts up during startup or recovery from shutdown mode.

De-popping circuitry of G1420 is shown on Figure D. The PNP transistor limits the voltage drop across the $50k\Omega$ by slewing the internal node slowly when power is applied. At start-up, the voltage at BYPASS capacitor is 0. The PNP is ON to pull the mid-point of the bias circuit down. So the capacitor sees a lower effective voltage, and thus the charging is slower. This appears as a linear ramp (while the PNP transistor is conducting), followed by the expected exponential ramp of an R-C circuit.

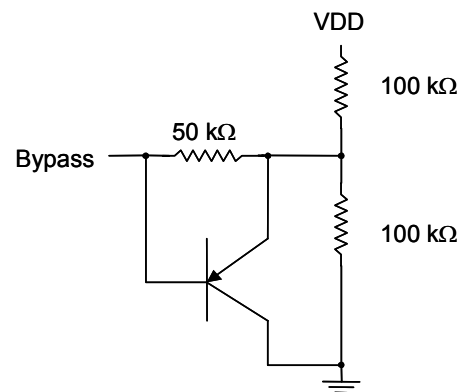

Figure D

Junction Temperature Measurement

Characterizing a PCB layout with respect to thermal impedance is very difficult, as it is usually impossible to know the junction temperature of the IC. G1420 TJ (pin 2) sources a current inversely proportional to the junction temperature. Typically TJ sources $120\mu A$ for a 5V supply at $25^\circ C$. And the slope is approximately $0.22\mu A/^\circ C$. As the resistors have a tolerance of $\pm 20\%$, these values should be calibrated on each device. When the temperature sensing function is not used, TJ pin can be left floating or tied to VDD to reduce the current consumption.

Temperature sensing circuit is shown on Figure E.

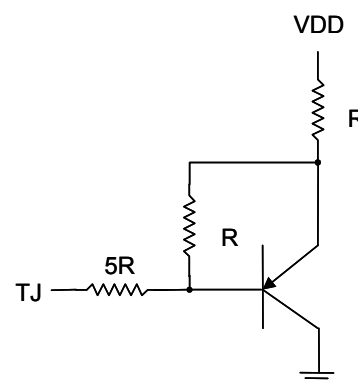
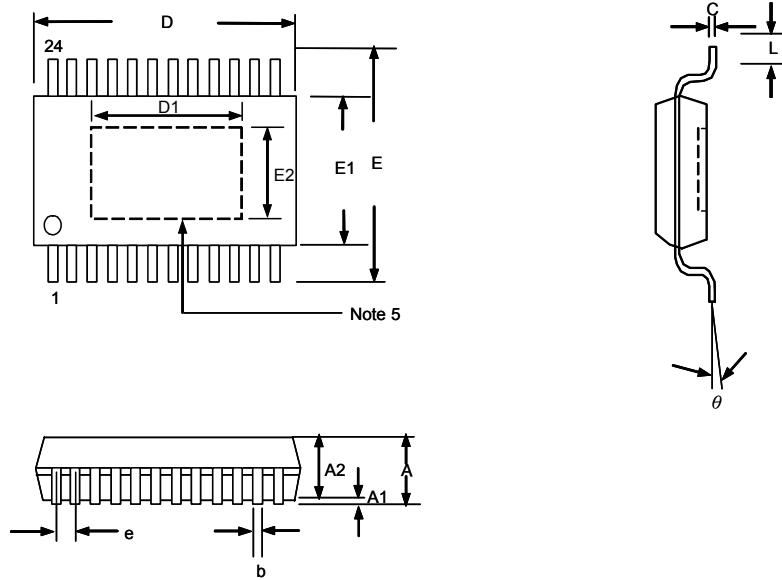

Figure E

Package Information



TSSOP-24 (FD) Package

NOTE:

1. Package body sizes exclude mold flash protrusions or gate burrs
2. Tolerance $\pm 0.1\text{mm}$ unless otherwise specified
3. Coplanarity : 0.1mm
4. Controlling dimension is millimeter. Converted inch dimensions are not necessarily exact.
5. Die pad exposure size is according to lead frame design.
6. Follow JEDEC MO-153

| SYMBOLS | DIMENSION IN MM | | | DIMENSION IN INCH | | |
|----------|-----------------|------|------|-------------------|-------|-------|
| | MIN | NOM | MAX | MIN | NOM | MAX |
| A | ---- | ---- | 1.20 | ---- | ---- | 0.047 |
| A1 | 0.00 | ---- | 0.15 | 0.000 | ---- | 0.006 |
| A2 | 0.80 | 1.00 | 1.05 | 0.031 | 0.039 | 0.041 |
| b | 0.19 | ---- | 0.30 | 0.007 | ---- | 0.012 |
| C | 0.20 | ---- | ---- | 0.008 | ---- | ---- |
| D | 7.7 | 7.8 | 7.9 | 0.303 | 0.307 | 0.311 |
| D1 | 4.4 | ---- | 4.9 | 0.173 | ---- | 0.193 |
| E | 6.40 BSC | | | 0.252 BSC | | |
| E1 | 4.30 | 4.40 | 4.50 | 0.169 | 0.173 | 0.177 |
| E2 | 2.7 | ---- | 3.2 | 0.106 | ---- | 0.126 |
| e | 0.65 BSC | | | 0.026 BSC | | |
| L | 0.45 | 0.60 | 0.75 | 0.018 | 0.024 | 0.030 |
| θ | 0° | ---- | 8° | 0° | ---- | 8° |

Taping Specification

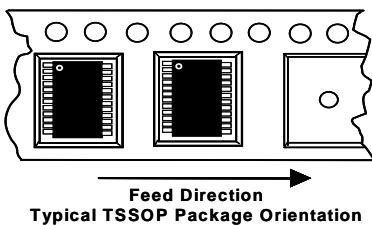

| PACKAGE | Q'TY/REEL |
|---------------|-----------|
| TSSOP-24 (FD) | 2,500 ea |