

International IOR Rectifier HEXFRED™

PD-95733

HFA04TB60PbF

Ultrafast, Soft Recovery Diode

Features

- Ultrafast Recovery
- Ultrasoft Recovery
- Very LOW I_{RRM}
- Very Low Q_{rr}
- Specified at Operating Conditions
- Lead-Free

Benefits

- Reduced RFI and EMI
- Reduced Power Loss in Diode and Switching Transistor
- Higher Frequency Operation
- Reduced Snubbing
- Reduced Parts Count

Description

International Rectifier's HFA04TB60 is a state of the art ultra fast recovery diode. Employing the latest in epitaxial construction and advanced processing techniques it features a superb combination of characteristics which result in performance which is unsurpassed by any rectifier previously available. With basic ratings of 600 volts and 8 amps per Leg continuous current, the HFA04TB60 is especially well suited for use as the companion diode for IGBTs and MOSFETs. In addition to ultra fast recovery time, the HEXFRED product line features extremely low values of peak recovery current (I_{RRM}) and does not exhibit any tendency to "snap-off" during the t_b portion of recovery. The HEXFRED features combine to offer designers a rectifier with lower noise and significantly lower switching losses in both the diode and the switching transistor. These HEXFRED advantages can help to significantly reduce snubbing, component count and heatsink sizes. The HEXFRED HFA04TB60 is ideally suited for applications in power supplies and power conversion systems (such as inverters), motor drives, and many other similar applications where high speed, high efficiency is needed.

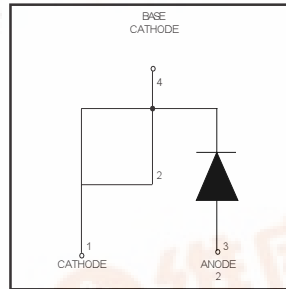

$V_R = 600V$
$V_F = 1.8V$
$Q_{rr}^* = 40nC$
$di_{(rec)}/dt^* = 280A/\mu s$
* 125°C

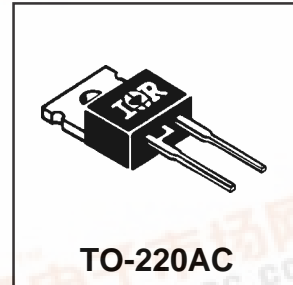

Absolute Maximum Ratings

	Parameter	Max	Units
V_R	Cathode-to-Anode Voltage	600	V
$I_F @ T_C = 100^\circ C$	Continuous Forward Current	4.0	A
I_{FSM}	Single Pulse Forward Current	25	
I_{FRM}	Maximum Repetitive Forward Current	16	
$P_D @ T_C = 25^\circ C$	Maximum Power Dissipation	25	W
$P_D @ T_C = 100^\circ C$	Maximum Power Dissipation	10	
T_J T_{STG}	Operating Junction and Storage Temperature Range	-55 to +150	C



Electrical Characteristics @ $T_J = 25^\circ\text{C}$ (unless otherwise specified)

	Parameter	Min	Typ	Max	Units	Test Conditions
V_{BR}	Cathode Anode Breakdown Voltage	600			V	$I_R = 100\mu\text{A}$
V_{FM}	Max Forward Voltage		1.5	1.8	V	$I_F = 4.0\text{A}$
			1.8	2.2		$I_F = 8.0\text{A}$ See Fig. 1
			1.4	1.7		$I_F = 4.0\text{A}, T_J = 125^\circ\text{C}$
I_{RM}	Max Reverse Leakage Current		0.17	3.0	μA	$V_R = V_R$ Rated See Fig. 2
			44	300		$T_J = 125^\circ\text{C}, V_R = 0.8 \times V_R$ Rated
C_T	Junction Capacitance		4.0	8.0	pF	$V_R = 200\text{V}$ See Fig. 3
L_S	Series Inductance		8.0		nH	Measured lead to lead 5mm from package body

Dynamic Recovery Characteristics @ $T_J = 25^\circ\text{C}$ (unless otherwise specified)

	Parameter	Min	Typ	Max	Units	Test Conditions
t_{rr}	Reverse Recovery Time		17		ns	$I_F = 1.0\text{A}, di_f/dt = 200\text{A}/\mu\text{s}, V_R = 30\text{V}$
t_{rr1}	See Fig. 5, 6 & 16		28	42		$T_J = 25^\circ\text{C}$
t_{rr2}			38	57		$T_J = 125^\circ\text{C}$
I_{RRM1}	Peak Recovery Current		2.9	5.2	A	$T_J = 25^\circ\text{C}$
I_{RRM2}	See Fig. 7 & 8		3.7	6.7		$T_J = 125^\circ\text{C}$
Q_{rr1}	Reverse Recovery Charge		40	60	nC	$T_J = 25^\circ\text{C}$
Q_{rr2}	See Fig. 9 & 10		70	105		$T_J = 125^\circ\text{C}$
$di_{(rec)M}/dt1$	Peak Rate of Fall of Recovery Current		280		$\text{A}/\mu\text{s}$	$T_J = 25^\circ\text{C}$
$di_{(rec)M}/dt2$	During t_b See Fig. 11 & 12		235			$T_J = 125^\circ\text{C}$

Thermal - Mechanical Characteristics

	Parameter	Min	Typ	Max	Units
$T_{lead}^{\text{①}}$	Lead Temperature			300	$^\circ\text{C}$
R_{thJC}	Thermal Resistance, Junction to Case			5.0	K/W
$R_{thA}^{\text{②}}$	Thermal Resistance, Junction to Ambient			80	
$R_{thS}^{\text{③}}$	Thermal Resistance, Case to Heat Sink		0.5		
Wt	Weight		2.0		g
			0.07		(oz)
T	Mounting Torque		6.0	12	Kg-cm
			5.0	10	lbf-in

- ① 0.063 in. from Case (1.6mm) for 10 sec
 ② Typical Socket Mount
 ③ Mounting Surface, Flat, Smooth and Greased

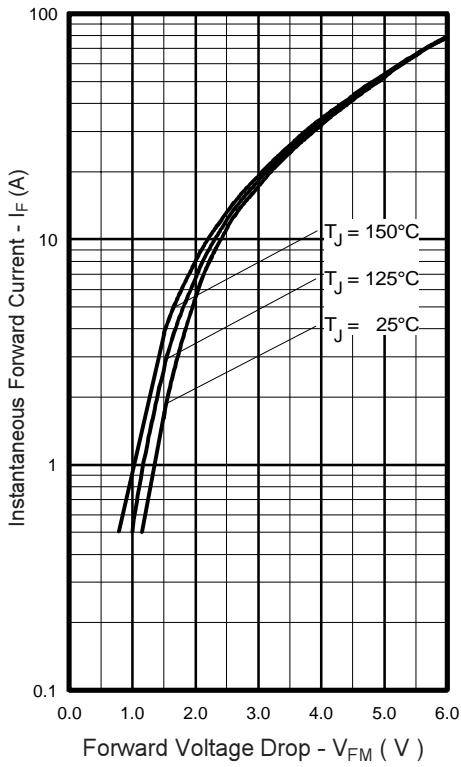

Fig. 1 - Maximum Forward Voltage Drop vs. Instantaneous Forward Current,

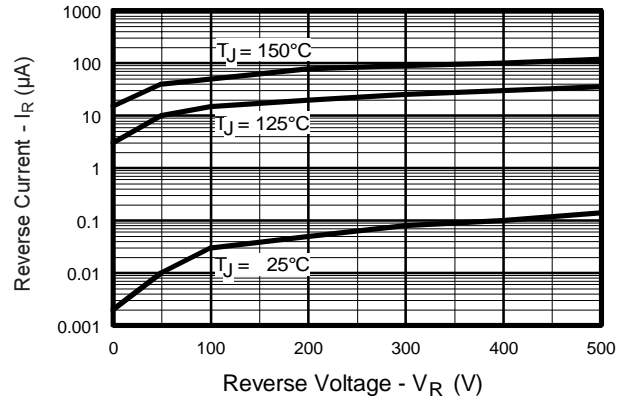

Fig. 2 - Typical Reverse Current vs. Reverse Voltage

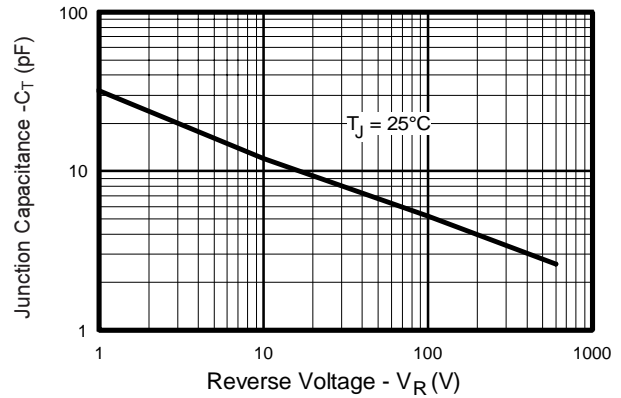

Fig. 3 - Typical Junction Capacitance vs. Reverse Voltage

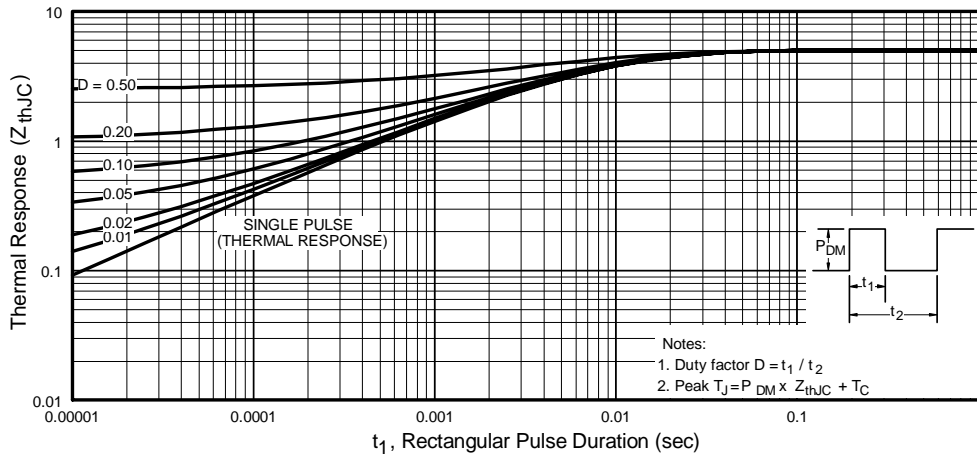

Fig. 4 - Maximum Thermal Impedance Z_{thJC} Characteristics

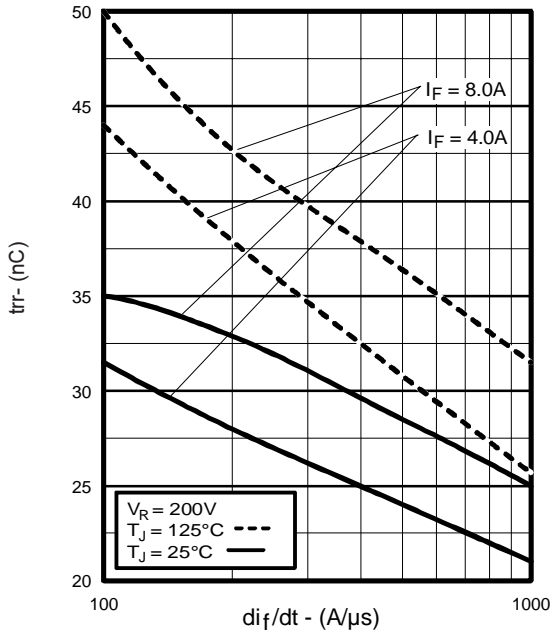

Fig. 5 - Typical Reverse Recovery vs. di_f/dt

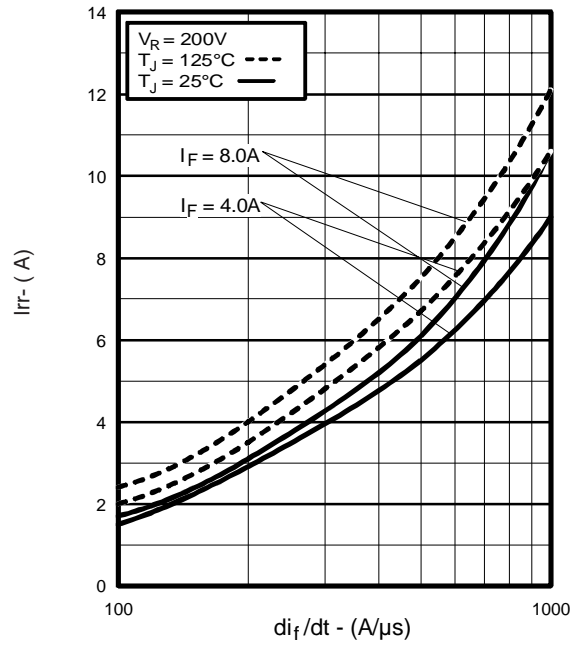

Fig. 6 - Typical Recovery Current vs. di_f/dt

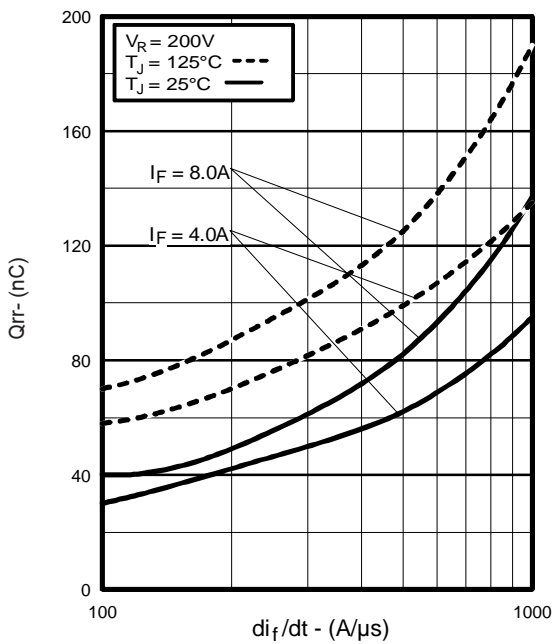

Fig. 7 - Typical Stored Charge vs. di_f/dt

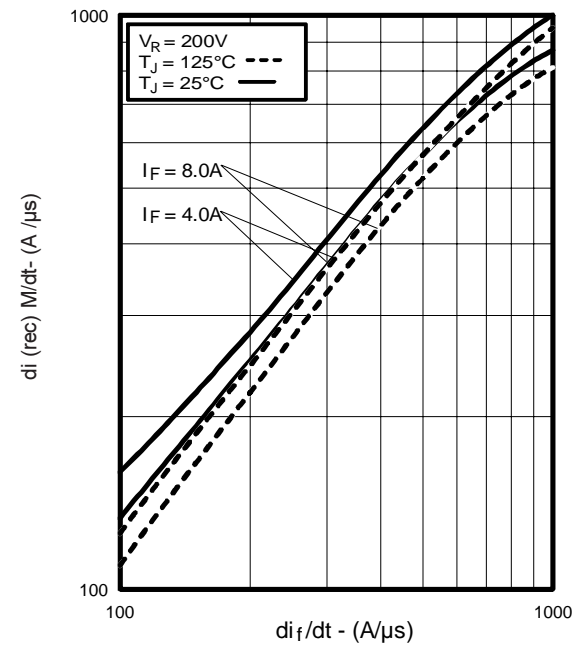

Fig. 8 - Typical $di_{(rec)M}/dt$ vs. di_f/dt

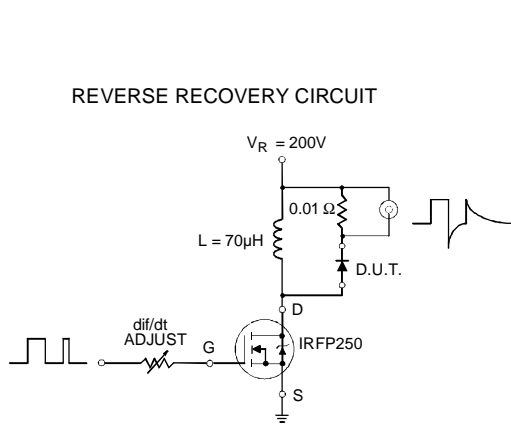

Fig. 9 - Reverse Recovery Parameter Test Circuit

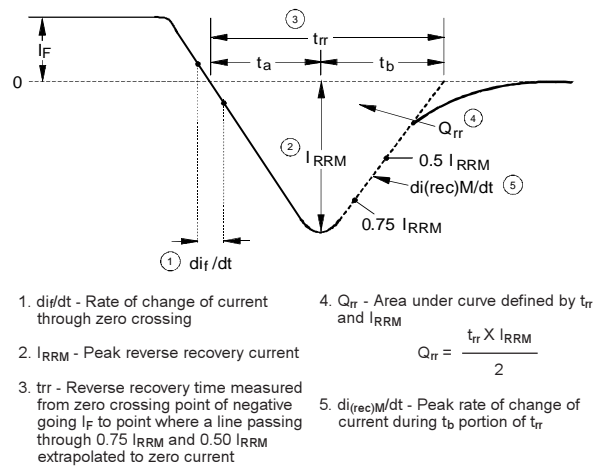

Fig. 10 - Reverse Recovery Waveform and Definitions

HFA04TB60PbF

International
IOR Rectifier

TO-220AC Package Outline

Dimensions are shown in millimeters (inches)

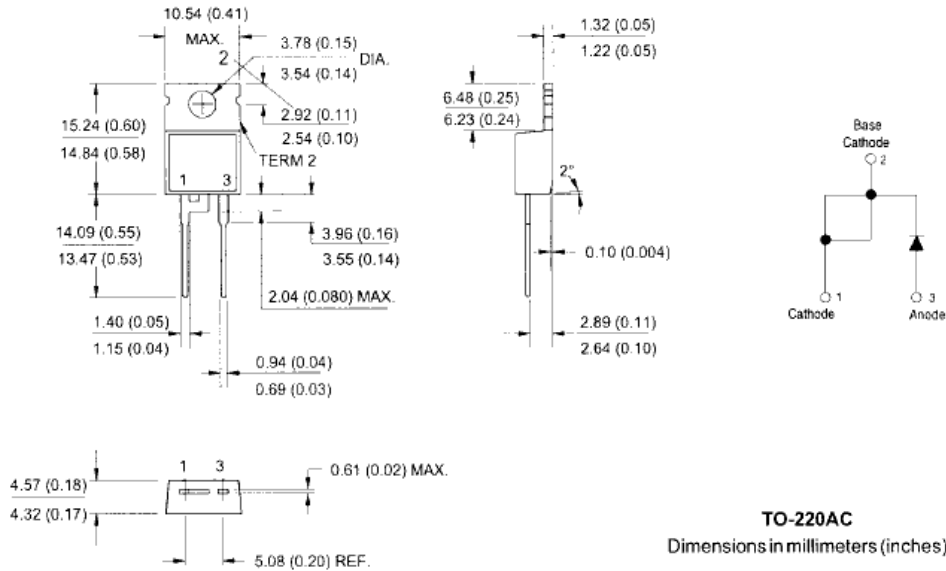

TO-220AC Part Marking Information

EXAMPLE: THIS IS A HFA06TB120
LOT CODE 1789
ASSEMBLED ON WW 19, 2001
IN THE ASSEMBLY LINE "C"

Note: "P" in the beginning of date code indicates "Lead-Free"

OR

EXAMPLE: THIS IS A HFA06TB120
LOT CODE 1789
ASSEMBLED ON WW 19, 2001
IN THE ASSEMBLY LINE "C"

Note: "P" in assembly line position indicates "Lead-Free"

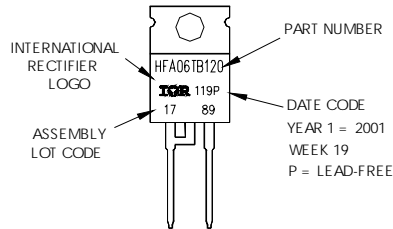
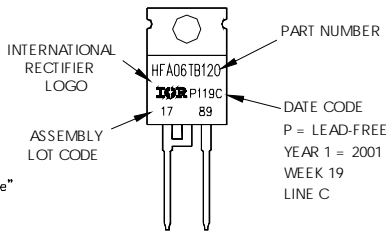

Data and specifications subject to change without notice.

International
IOR Rectifier

IR WORLD HEADQUARTERS: 233 Kansas St., El Segundo, California 90245, USA Tel: (310) 252-7105
TAC Fax: (310) 252-7903

Visit us at www.irf.com for sales contact information. 10/04