

International Rectifier

HEXFRED™

HFA06TB120PbF

Ultrafast, Soft Recovery Diode

Features

- Ultrafast Recovery
- Ultrasoft Recovery
- Very Low I_{RRM}
- Very Low Q_{rr}
- Specified at Operating Conditions
- Lead-Free

Benefits

- Reduced RFI and EMI
- Reduced Power Loss in Diode and Switching Transistor
- Higher Frequency Operation
- Reduced Snubbing
- Reduced Parts Count

Description

International Rectifier's HFA06TB120 is a state of the art ultra fast recovery diode. Employing the latest in epitaxial construction and advanced processing techniques it features a superb combination of characteristics which result in performance which is unsurpassed by any rectifier previously available. With basic ratings of 1200 volts and 6 amps continuous current, the HFA06TB120 is especially well suited for use as the companion diode for IGBTs and MOSFETs. In addition to ultra fast recovery time, the HEXFRED product line features extremely low values of peak recovery current (I_{RRM}) and does not exhibit any tendency to "snap-off" during the t_b portion of recovery. The HEXFRED features combine to offer designers a rectifier with lower noise and significantly lower switching losses in both the diode and the switching transistor. These HEXFRED advantages can help to significantly reduce snubbing, component count and heatsink sizes. The HEXFRED HFA06TB120 is ideally suited for applications in power supplies and power conversion systems (such as inverters), motor drives, and many other similar applications where high speed, high efficiency is needed.

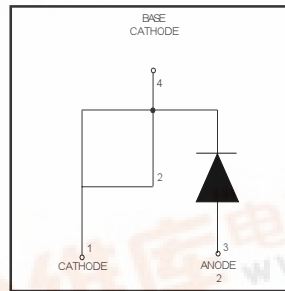

$V_R = 1200V$
$V_F(\text{typ.})^* = 2.4V$
$I_{F(AV)} = 6.0A$
$Q_{rr}(\text{typ.}) = 116nC$
$I_{RRM}(\text{typ.}) = 4.4A$
$t_{rr}(\text{typ.}) = 26ns$
$di_{(rec)M}/dt(\text{typ.})^* = 100A/\mu s$

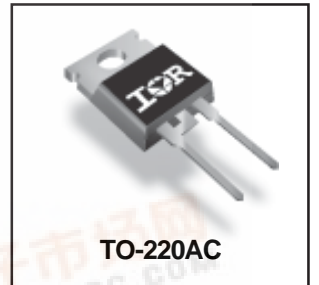

Absolute Maximum Ratings

	Parameter	Max.	Units
V_R	Cathode-to-Anode Voltage	1200	V
$I_F @ T_C = 100^\circ C$	Continuous Forward Current	8.0	A
I_{FSM}	Single Pulse Forward Current	80	
I_{FRM}	Maximum Repetitive Forward Current	24	
$P_D @ T_C = 25^\circ C$	Maximum Power Dissipation	62.5	W
$P_D @ T_C = 100^\circ C$	Maximum Power Dissipation	25	
T_J	Operating Junction and Storage Temperature Range	-55 to +150	$^\circ C$



HFA06TB120PbF

Electrical Characteristics @ $T_J = 25^\circ\text{C}$ (unless otherwise specified)

	Parameter	Min.	Typ.	Max.	Units	Test Conditions
V_{BR}	Cathode Anode Breakdown Voltage	1200	—	—	V	$I_R = 100\mu\text{A}$
V_{FM}	Max. Forward Voltage	—	2.7	3.0	V	$I_F = 6.0\text{A}$
		—	3.5	3.9		$I_F = 12\text{A}$
		—	2.4	2.8		$I_F = 6.0\text{A}, T_J = 125^\circ\text{C}$
I_{RM}	Max. Reverse Leakage Current	—	0.26	5.0	μA	$V_R = V_R \text{ Rated}$
		—	110	500		$T_J = 125^\circ\text{C}, V_R = 0.8 \times V_R \text{ Rated}$
C_T	Junction Capacitance	—	9.0	14	pF	$V_R = 200\text{V}$
L_S	Series Inductance	—	8.0	—	nH	Measured lead to lead 5mm from pkg body

Dynamic Recovery Characteristics @ $T_J = 25^\circ\text{C}$ (unless otherwise specified)

	Parameter	Min.	Typ.	Max.	Units	Test Conditions
t_{rr}	Reverse Recovery Time	—	26	—	ns	$I_F = 1.0\text{A}, di_f/dt = 200\text{A}/\mu\text{s}, V_R = 30\text{V}$
t_{rr1}		—	53	80		$T_J = 25^\circ\text{C}$
t_{rr2}		—	87	130		$T_J = 125^\circ\text{C}$
I_{RRM1}	Peak Recovery Current	—	4.4	8.0	A	$T_J = 25^\circ\text{C}$
I_{RRM2}		—	5.0	9.0		$T_J = 125^\circ\text{C}$
Q_{rr1}	Reverse Recovery Charge	—	116	320	nC	$T_J = 25^\circ\text{C}$
Q_{rr2}		—	233	585		$T_J = 125^\circ\text{C}$
$di_{(rec)M}/dt1$	Peak Rate of Recovery	—	180	—	$\text{A}/\mu\text{s}$	$T_J = 25^\circ\text{C}$
$di_{(rec)M}/dt2$	Current During t_b	—	100	—		$T_J = 125^\circ\text{C}$

$I_F = 6.0\text{A}$
 $V_R = 200\text{V}$
 $di_f/dt = 200\text{A}/\mu\text{s}$

Thermal - Mechanical Characteristics

	Parameter	Min.	Typ.	Max.	Units
$T_{\text{lead}} \textcircled{1}$	Lead Temperature	—	—	300	$^\circ\text{C}$
R_{thJC}	Thermal Resistance, Junction to Case	—	—	2.0	K/W
$R_{\text{thJA}} \textcircled{2}$	Thermal Resistance, Junction to Ambient	—	—	80	
$R_{\text{thCS}} \textcircled{3}$	Thermal Resistance, Case to Heat Sink	—	0.5	—	
W_t	Weight	—	2.0	—	g
		—	0.07	—	(oz)
	Mounting Torque	6.0	—	12	Kg-cm
		5.0	—	10	lbf-in

$\textcircled{1}$ 0.063 in. from Case (1.6mm) for 10 sec

$\textcircled{2}$ Typical Socket Mount

$\textcircled{3}$ Mounting Surface, Flat, Smooth and Greased

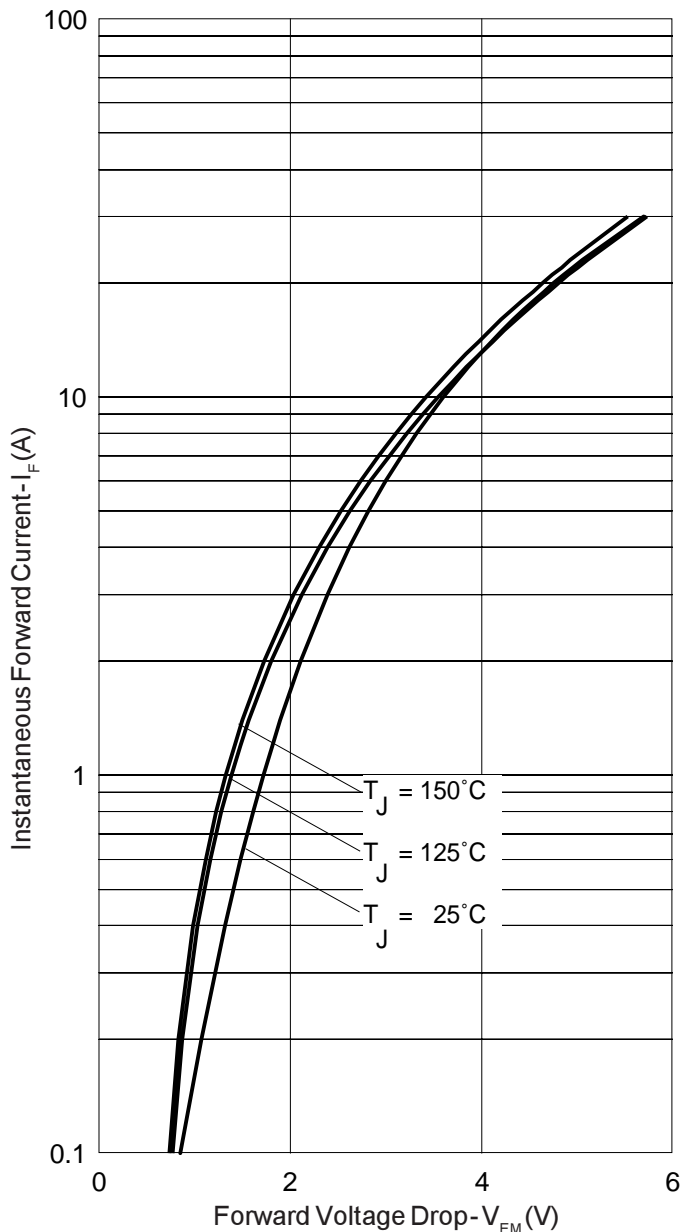

Fig. 1 - Typical Forward Voltage Drop Characteristics

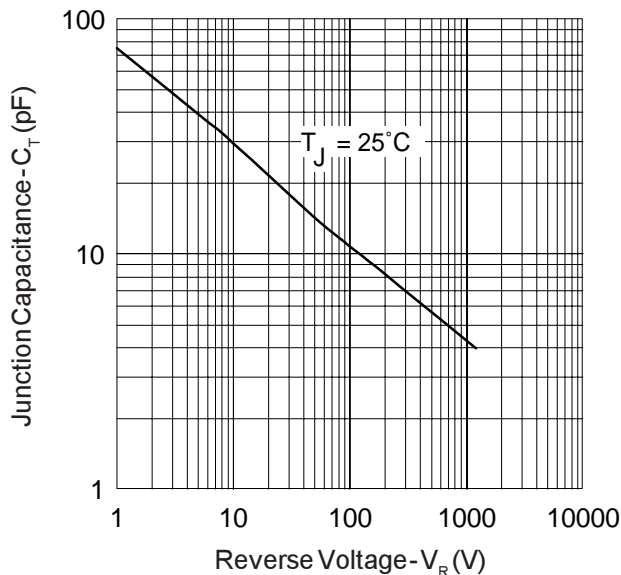
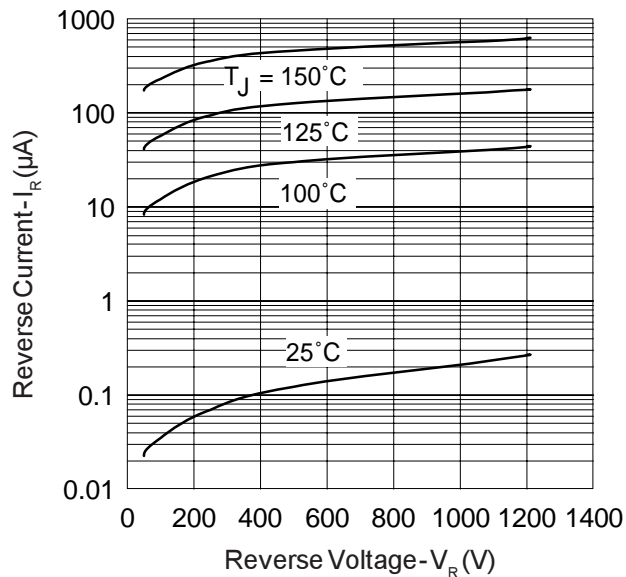
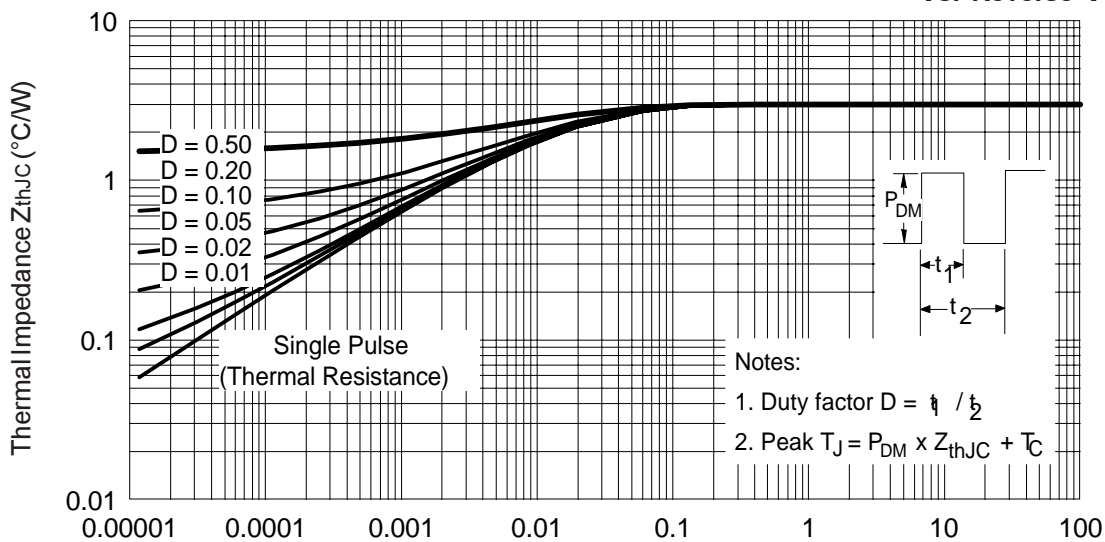

Fig. 3 - Typical Junction Capacitance Vs. Reverse Voltage



Notes:

1. Duty factor $D = t_1 / t_2$
2. Peak $T_J = P_{DM} \times Z_{thJC} + T_C$

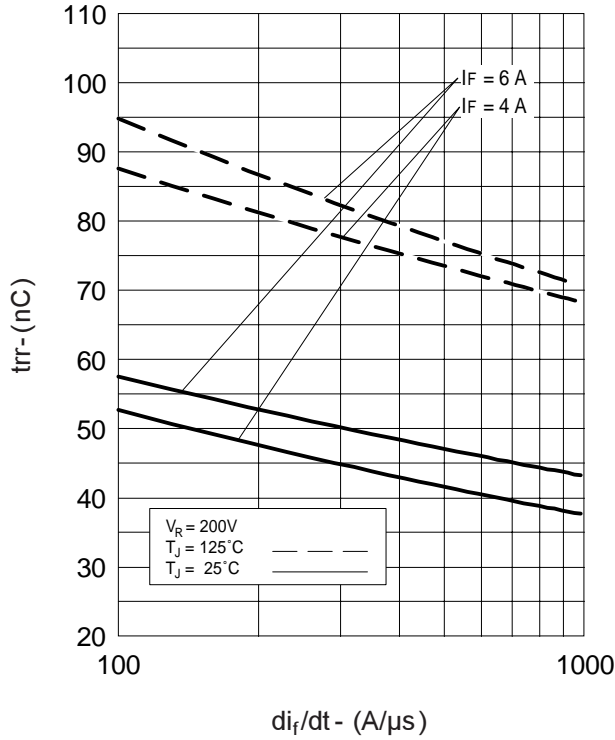

Fig. 5 - Typical Reverse Recovery Vs. di_f/dt

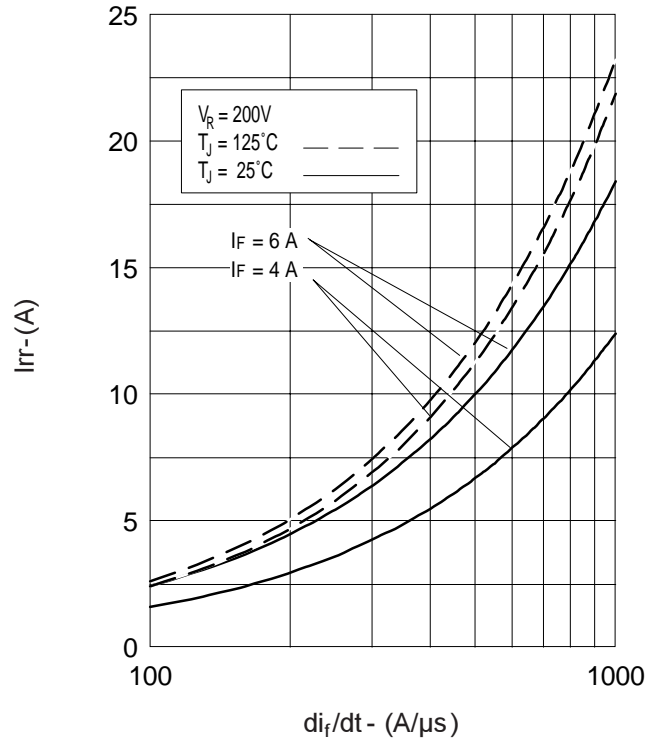

Fig. 6 - Typical Recovery Current Vs. di_f/dt

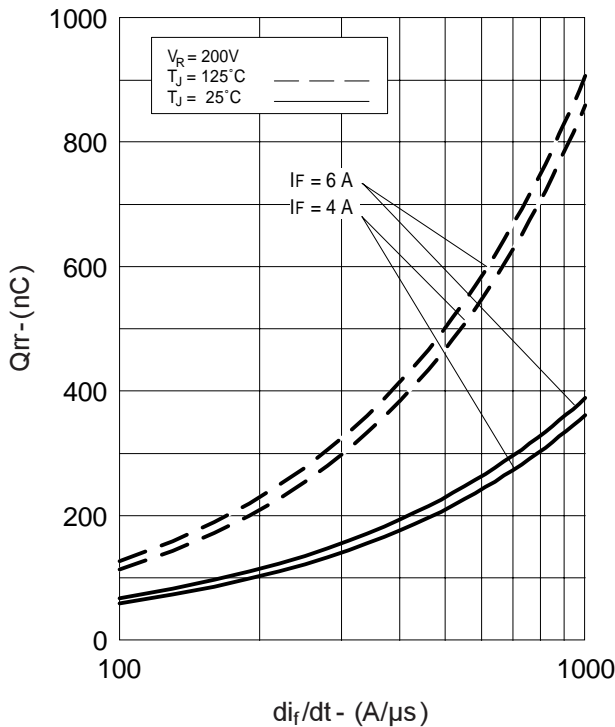

Fig. 8 - Typical Stored Charge vs. di_f/dt

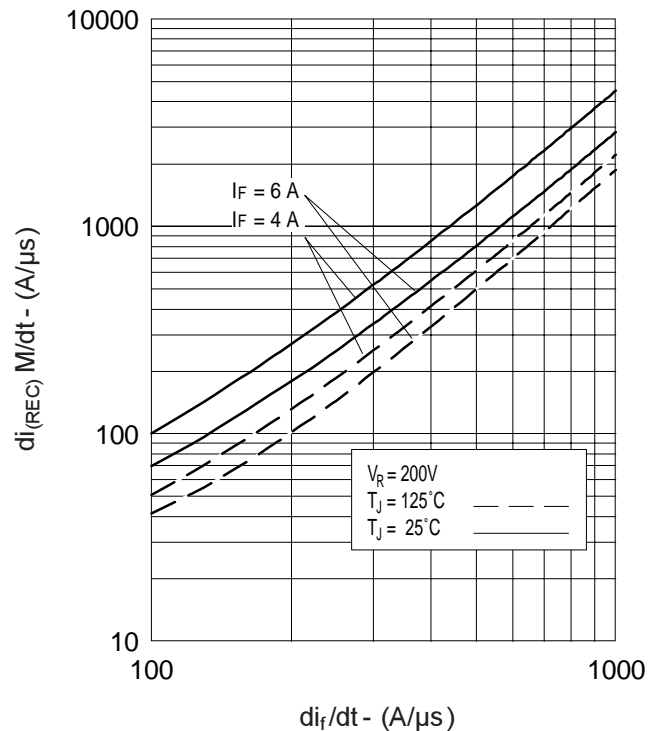

Fig. 7 - Typical $di_{(REC)}$ M/dt vs. di_f/dt

REVERSE RECOVERY CIRCUIT

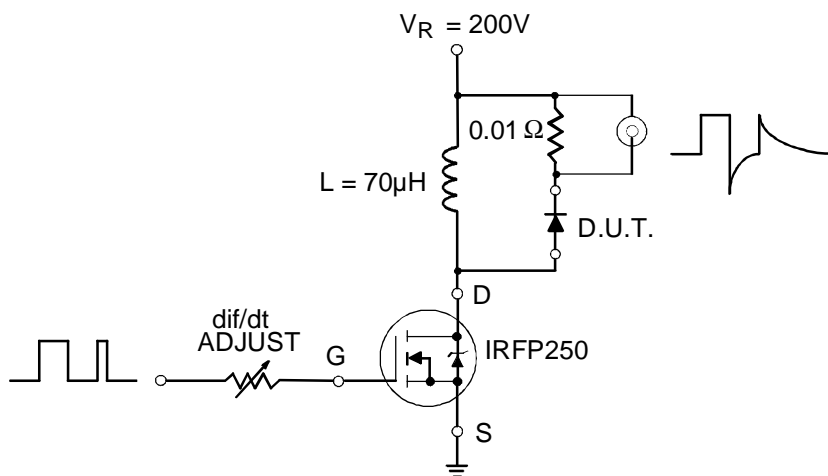
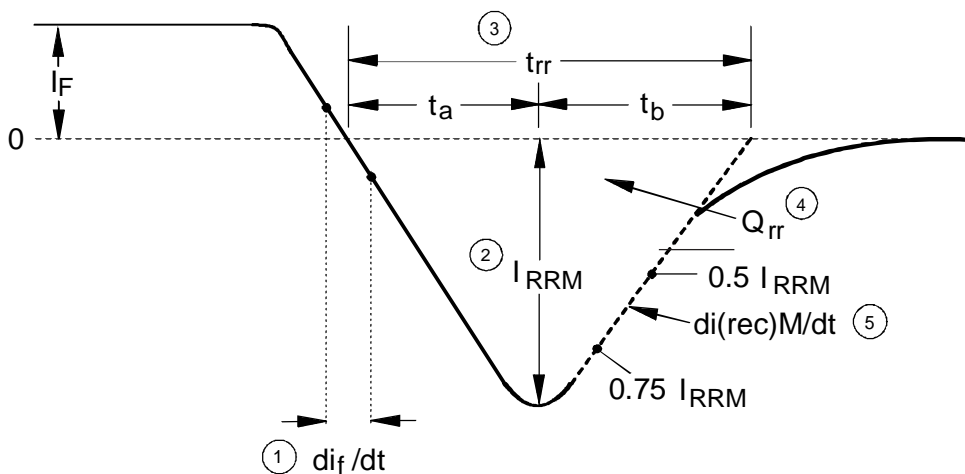

Fig. 9- Reverse Recovery Parameter Test Circuit



1. di_f/dt - Rate of change of current through zero crossing

2. I_{RRM} - Peak reverse recovery current

3. t_{rr} - Reverse recovery time measured from zero crossing point of negative going I_F to point where a line passing through $0.75 I_{RRM}$ and $0.50 I_{RRM}$ extrapolated to zero current

4. Q_{rr} - Area under curve defined by t_{rr} and I_{RRM}

$$Q_{rr} = \frac{t_{rr} \times I_{RRM}}{2}$$

5. $di_{(rec)M}/dt$ - Peak rate of change of current during t_b portion of t_{rr}

Fig. 10 - Reverse Recovery Waveform and Definitions

HFA06TB120PbF

TO-220AC Package Outline

Dimensions are shown in millimeters (inches)

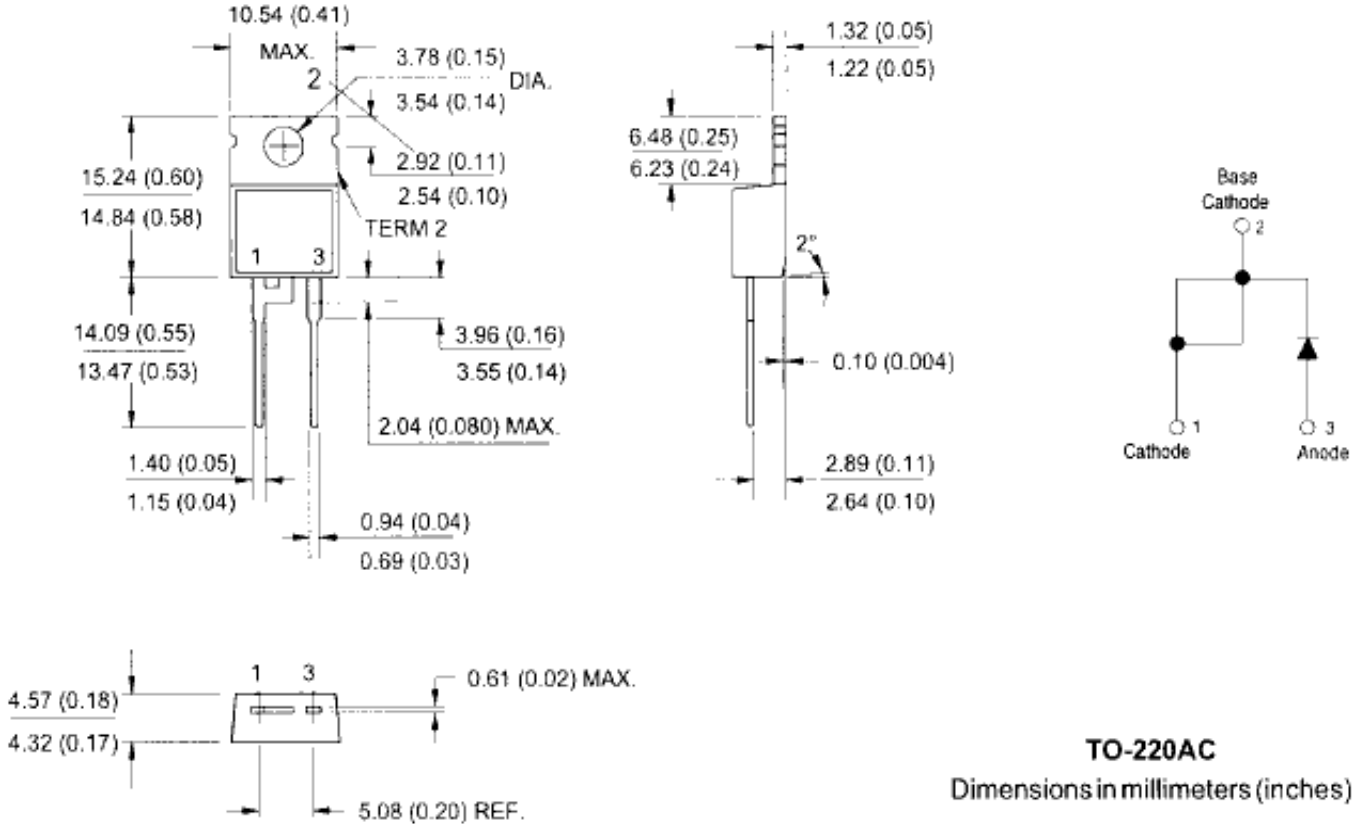

TO-220AC Part Marking Information

EXAMPLE: THIS IS A HFA06TB120
LOT CODE 1789
ASSEMBLED ON WW 19, 2001
IN THE ASSEMBLY LINE "C"

Note: "P" in the beginning of date code indicates "Lead-Free"

OR

EXAMPLE: THIS IS A HFA06TB120
LOT CODE 1789
ASSEMBLED ON WW 19, 2001
IN THE ASSEMBLY LINE "C"

Note: "P" in assembly line position indicates "Lead-Free"

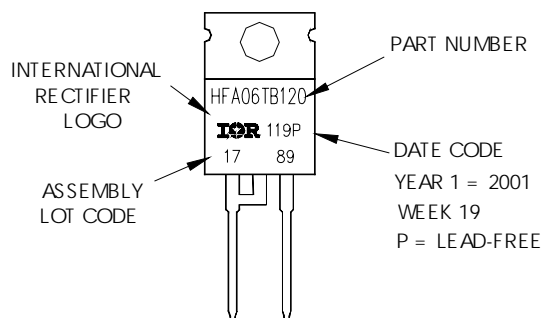
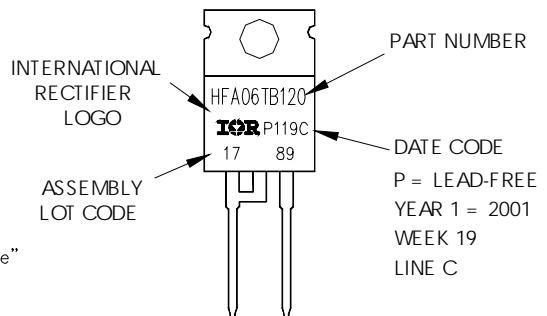

Ordering Information Table

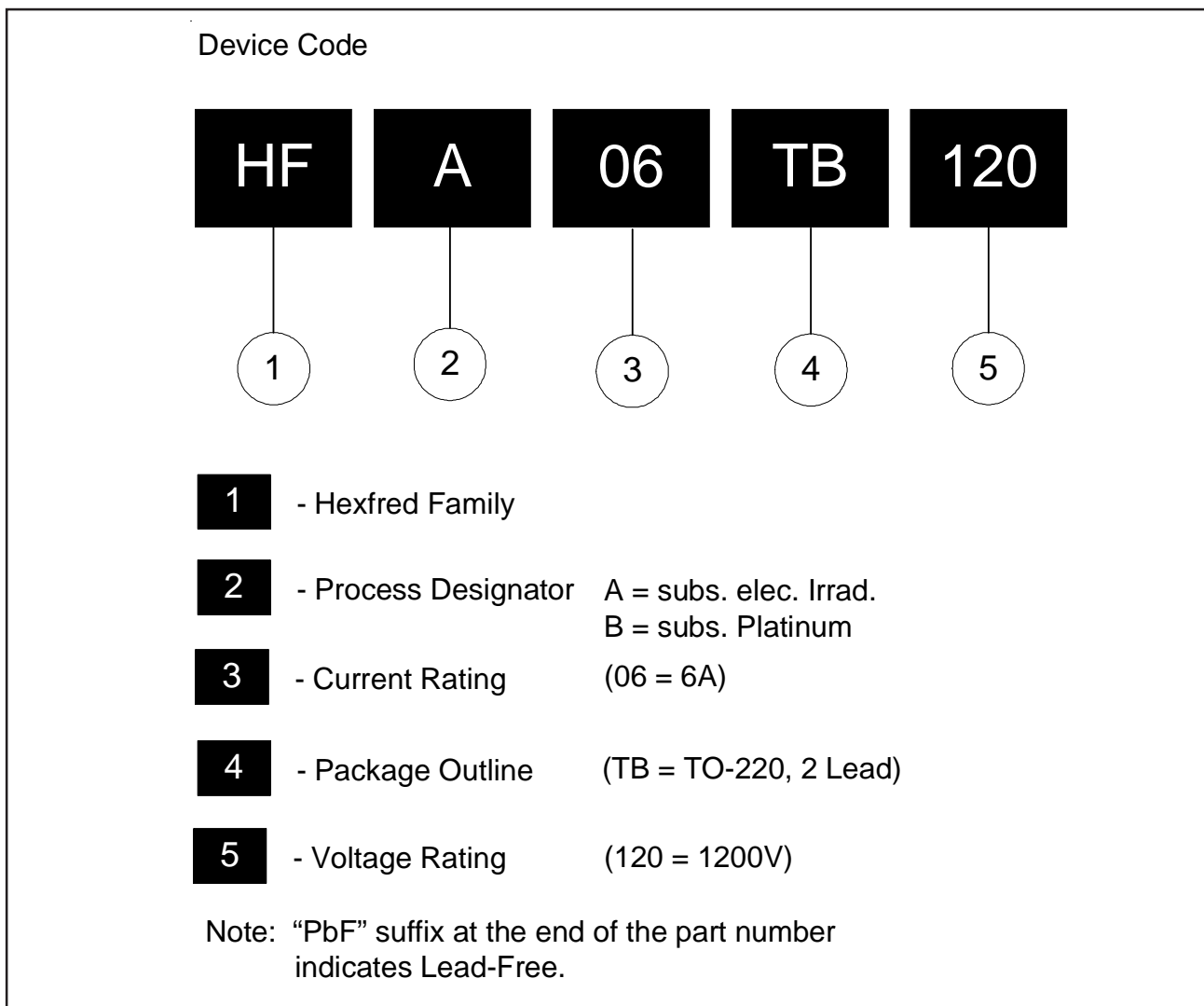

Data and specifications subject to change without notice.