

# International IR Rectifier HEXFRED™

PD-96037

## HFA08TB60SPbF

Ultrafast, Soft Recovery Diode

### Features

- Ultrafast Recovery
- Ultrasoft Recovery
- Very Low  $I_{RRM}$
- Very Low  $Q_{rr}$
- Specified at Operating Conditions
- Lead-Free

### Benefits

- Reduced RFI and EMI
- Reduced Power Loss in Diode and Switching Transistor
- Higher Frequency Operation
- Reduced Snubbing
- Reduced Parts Count

### Description

International Rectifier's HFA08TB60S is a state of the art ultra fast recovery diode. Employing the latest in epitaxial construction and advanced processing techniques it features a superb combination of characteristics which result in performance which is unsurpassed by any rectifier previously available. With basic ratings of 600 volts and 8 amps continuous current, the HFA08TB60S is especially well suited for use as the companion diode for IGBTs and MOSFETs. In addition to ultra fast recovery time, the HEXFRED product line features extremely low values of peak recovery current ( $I_{RRM}$ ) and does not exhibit any tendency to "snap-off" during the  $t_b$  portion of recovery. The HEXFRED features combine to offer designers a rectifier with lower noise and significantly lower switching losses in both the diode and the switching transistor. These HEXFRED advantages can help to significantly reduce snubbing, component count and heatsink sizes. The HEXFRED HFA08TB60S is ideally suited for applications in power supplies (PFC Boost diode) and power conversion systems (such as inverters), motor drives, and many other similar applications where high speed, high efficiency is needed.

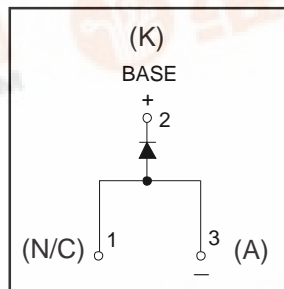

$V_R = 600V$
$V_F(\text{typ.})^* = 1.4V$
$I_F(\text{AV}) = 8.0A$
$Q_{rr}(\text{typ.}) = 65nC$
$I_{RRM} = 5.0A$
$t_{rr}(\text{typ.}) = 18ns$
$di_{(rec)M}/dt(\text{typ.}) = 240A/\mu s$

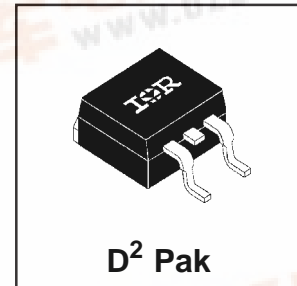

### Absolute Maximum Ratings

	Parameter	Max.	Units
$V_R$	Cathode-to-Anode Voltage	600	V
$I_F @ T_C = 100^\circ C$	Continuous Forward Current	8.0	A
$I_{FSM}$	Single Pulse Forward Current	60	
$I_{FRM}$	Maximum Repetitive Forward Current	24	
$P_D @ T_C = 25^\circ C$	Maximum Power Dissipation	36	W
$P_D @ T_C = 100^\circ C$	Maximum Power Dissipation	14	
$T_J$	Operating Junction and	-55 to +150	$^\circ C$
$T_{STG}$	Storage Temperature Range		

\* 125°C

www.irf.com

1

10/07/05



# HFA08TB60SPbF

International  
**IRF** Rectifier

## Electrical Characteristics @ T<sub>J</sub> = 25°C (unless otherwise specified)

	Parameter	Min.	Typ.	Max.	Units	Test Conditions
V <sub>BR</sub>	Cathode Anode Breakdown Voltage	600	—	—	V	I <sub>R</sub> = 100μA
V <sub>FM</sub>	Max Forward Voltage	—	1.4	1.7	V	I <sub>F</sub> = 8.0A
		—	1.7	2.1		I <sub>F</sub> = 16A See Fig. 1
		—	1.4	1.7		I <sub>F</sub> = 8.0A, T <sub>J</sub> = 125°C
I <sub>RM</sub>	Max Reverse Leakage Current	—	0.3	5.0	μA	V <sub>R</sub> = V <sub>R</sub> Rated See Fig. 2
		—	100	500		T <sub>J</sub> = 125°C, V <sub>R</sub> = 0.8 x V <sub>R</sub> Rated
C <sub>T</sub>	Junction Capacitance	—	10	25	pF	V <sub>R</sub> = 200V See Fig. 3
L <sub>S</sub>	Series Inductance	—	8.0	—	nH	Measured lead to lead 5mm from package body

## Dynamic Recovery Characteristics @ T<sub>J</sub> = 25°C (unless otherwise specified)

	Parameter	Min.	Typ.	Max.	Units	Test Conditions
t <sub>rr</sub>	Reverse Recovery Time	—	18	—	ns	I <sub>F</sub> = 1.0A, di/dt = 200A/μs, V <sub>R</sub> = 30V
t <sub>rr1</sub>	See Fig. 5, 6	—	37	55		T <sub>J</sub> = 25°C
t <sub>rr2</sub>		—	55	90		T <sub>J</sub> = 125°C
I <sub>RRM1</sub>	Peak Recovery Current	—	3.5	5.0	A	T <sub>J</sub> = 25°C
		—	4.5	8.0		T <sub>J</sub> = 125°C
Q <sub>rr1</sub>	Reverse Recovery Charge See Fig. 7	—	65	138	nC	T <sub>J</sub> = 25°C
Q <sub>rr2</sub>		—	124	360		T <sub>J</sub> = 125°C
di <sub>(rec)M</sub> /dt1	Peak Rate of Fall of Recovery Current During t <sub>b</sub> See Fig. 8	—	240	—	A/μs	T <sub>J</sub> = 25°C
di <sub>(rec)M</sub> /dt2		—	210	—		T <sub>J</sub> = 125°C

## Thermal - Mechanical Characteristics

	Parameter	Min.	Typ.	Max.	Units
T <sub>lead</sub> ①	Lead Temperature	—	—	300	°C
R <sub>thJC</sub>	Thermal Resistance, Junction to Case	—	—	3.5	K/W
R <sub>thJA</sub> ②	Thermal Resistance, Junction to Ambient	—	—	80	
Wt	Weight	—	2.0	—	g
		—	0.07	—	(oz)

① 0.063 in. from Case (1.6mm) for 10 sec

② Typical Socket Mount

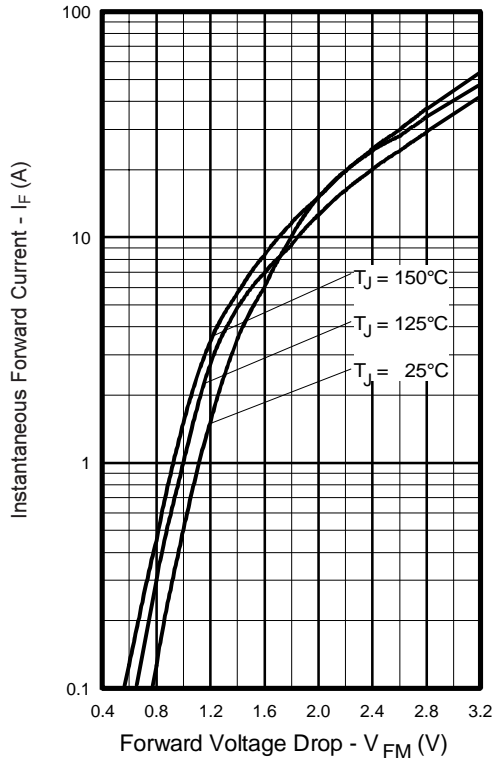

**Fig. 1 - Maximum Forward Voltage Drop vs. Instantaneous Forward Current**

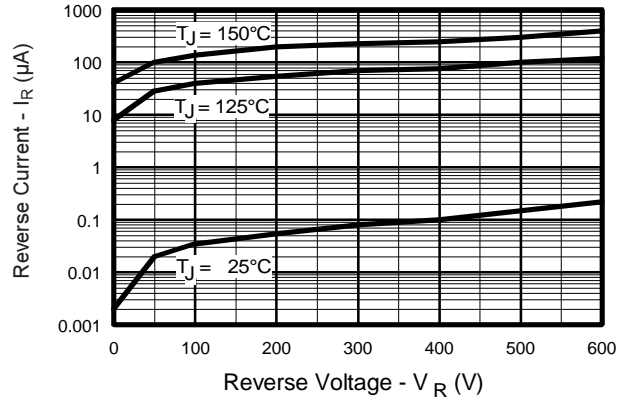

**Fig. 2 - Typical Reverse Current vs. Reverse Voltage**

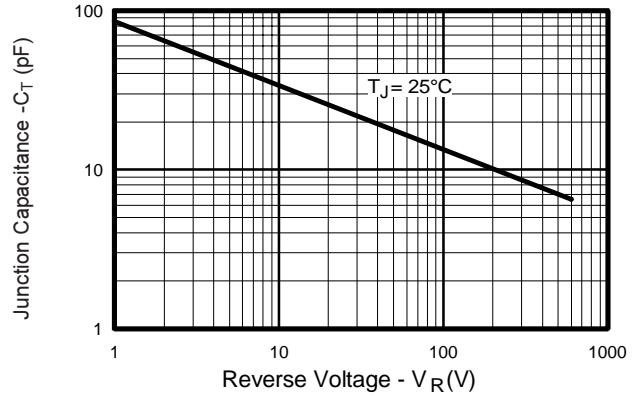

**Fig. 3 - Typical Junction Capacitance vs. Reverse Voltage**

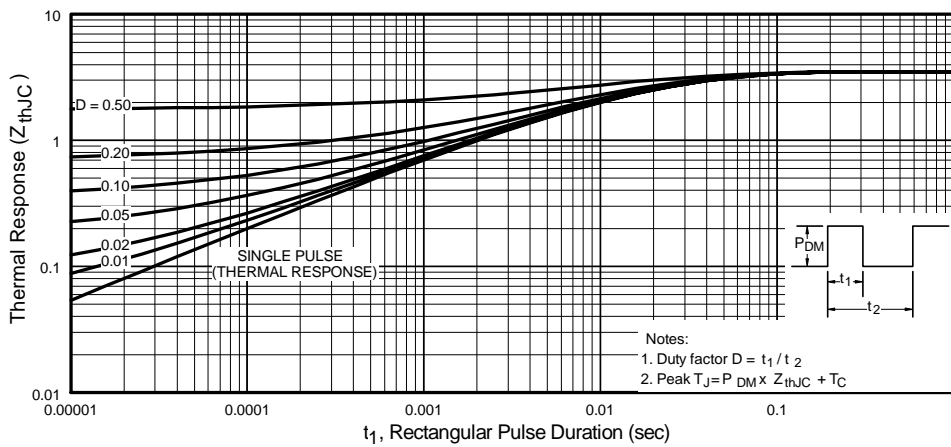

**Fig. 4 - Maximum Thermal Impedance  $Z_{thJC}$  Characteristics**

# HFA08TB60SPbF

International  
**IR** Rectifier

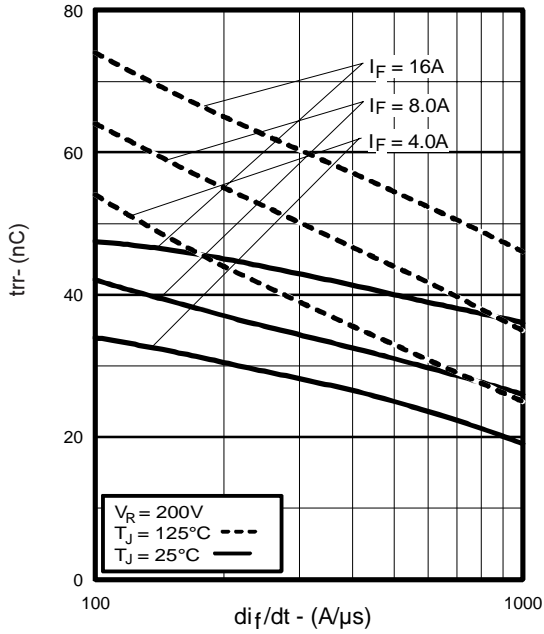

Fig. 5 - Typical Reverse Recovery vs.  $di_f/dt$

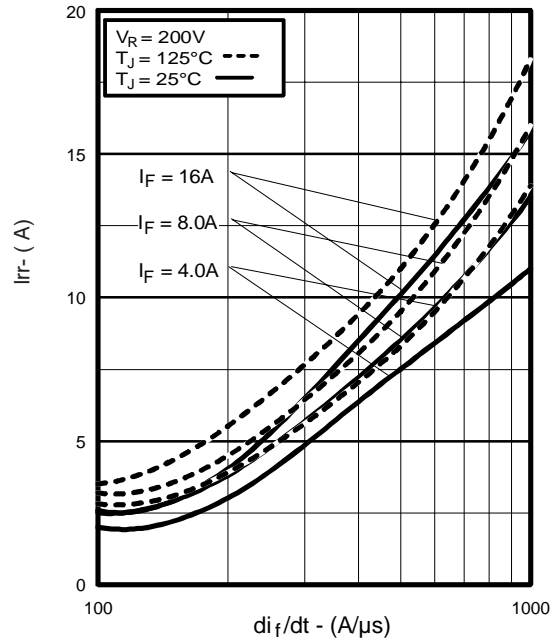

Fig. 6 - Typical Recovery Current vs.  $di_f/dt$

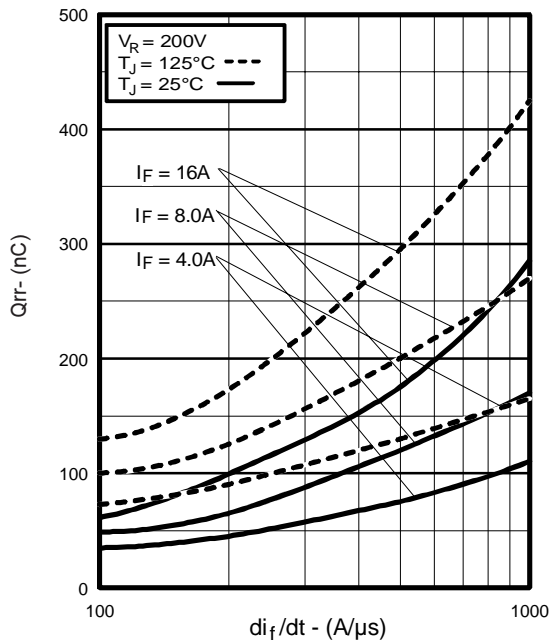

Fig. 7 - Typical Stored Charge vs.  $di_f/dt$

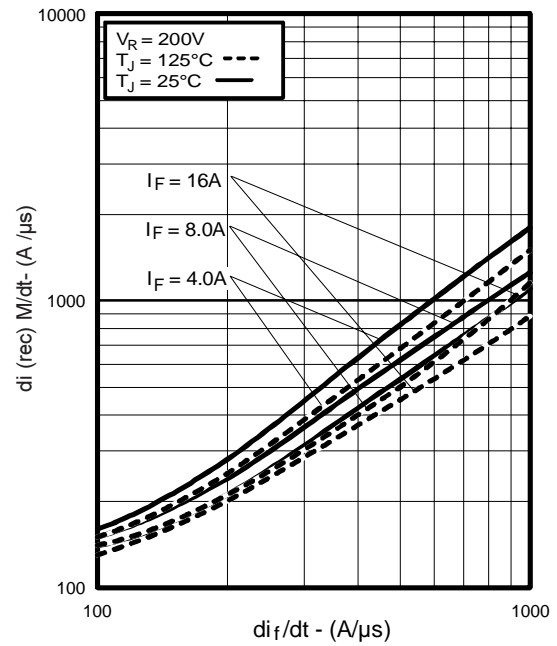
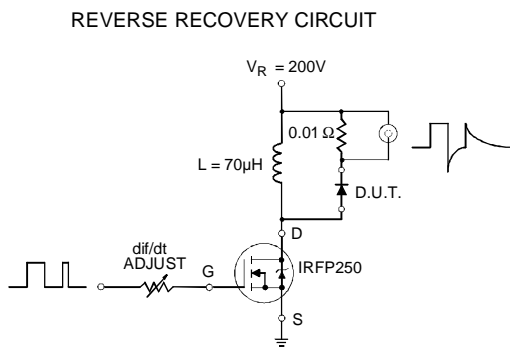
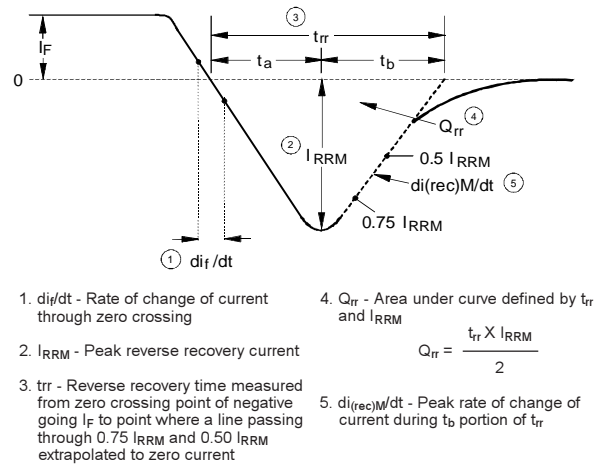

Fig. 8 - Typical  $di_{(rec)M}/dt$  vs.  $di_f/dt$



**Fig. 9 - Reverse Recovery Parameter Test Circuit**



**Fig. 10 - Reverse Recovery Waveform and Definitions**

# HFA08TB60SPbF

International  
**IR** Rectifier

## D<sup>2</sup>PAK Package Outline

Dimensions are shown in millimeters (inches)

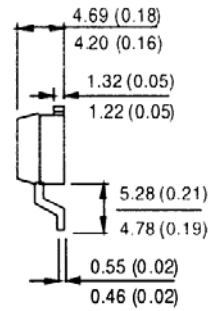
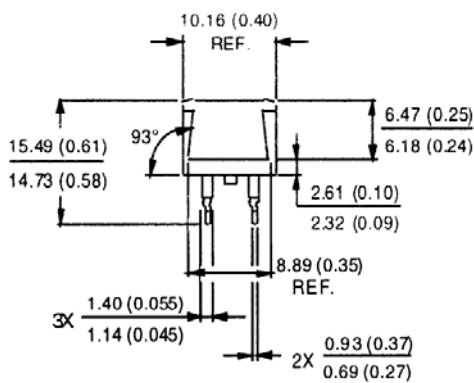

MINIMUM RECOMMENDED FOOTPRINT

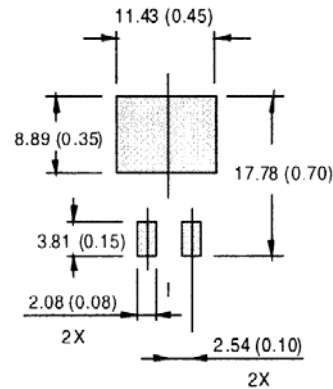
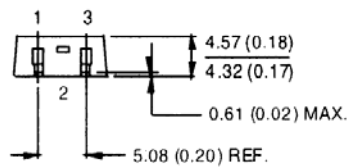

Conforms to JEDEC Outline D<sup>2</sup>PAK  
Dimensions in millimeters and inches

## D<sup>2</sup>PAK Part Marking Information

EXAMPLE: THIS IS A HFA08TB60S

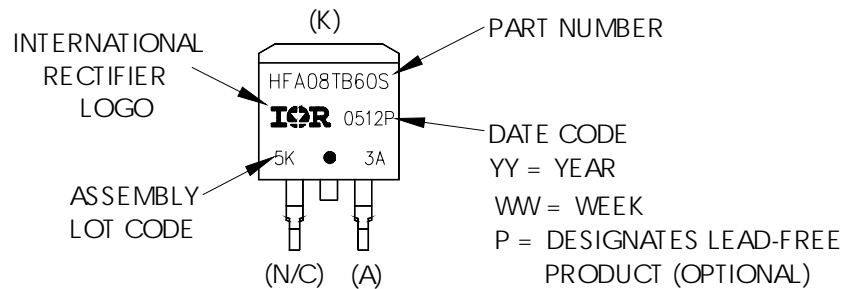

## D<sup>2</sup>PAK Tape & Reel Information

Dimensions are shown in millimeters (inches)

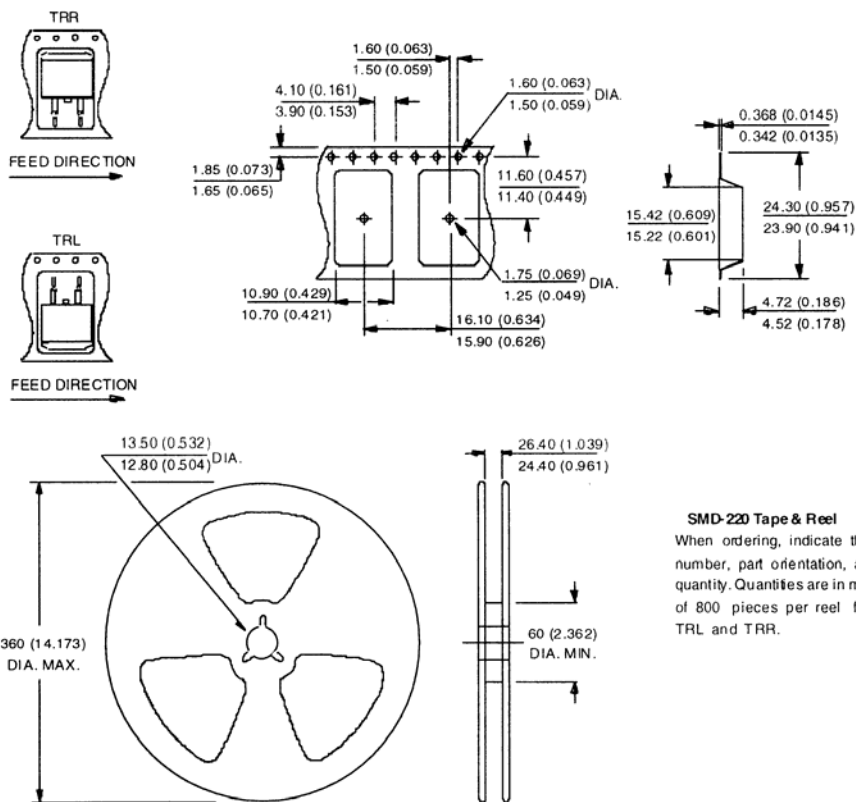

### SMD-220 Tape & Reel

When ordering, indicate the part number, part orientation, and the quantity. Quantities are in multiples of 800 pieces per reel for both TRL and TRR.

Data and specifications subject to change without notice.  
 This product has been designed and qualified for the Consumer market.  
 Qualifications Standards can be found on IR's Web site.

International  
**IR** Rectifier

IR WORLD HEADQUARTERS: 233 Kansas St., El Segundo, California 90245, USA Tel: (310) 252-7105

TAC Fax: (310) 252-7903

Visit us at [www.irf.com](http://www.irf.com) for sales contact information.10/05