

International
IR Rectifier
HEXFRED™

PD-95689

HFA30TA60CPbF

Ultrafast, Soft Recovery Diode

Features

- Ultrafast Recovery
- Ultrasoft Recovery
- Very Low I_{RRM}
- Very Low Q_{rr}
- Guaranteed Avalanche
- Specified at Operating Conditions
- Lead-Free

Benefits

- Reduced RFI and EMI
- Reduced Power Loss in Diode and Switching Transistor
- Higher Frequency Operation
- Reduced Snubbing
- Reduced Parts Count

Description

International Rectifier's HFA30TA60C is a state of the art center tap ultra fast recovery diode. Employing the latest in epitaxial construction and advanced processing techniques it features a superb combination of characteristics which result in performance which is unsurpassed by any rectifier previously available. With basic ratings of 600 volts and 15 amps per Leg continuous current, the HFA30TA60C is especially well suited for use as the companion diode for IGBTs and MOSFETs. In addition to ultra fast recovery time, the HEXFRED product line features extremely low values of peak recovery current (I_{RRM}) and does not exhibit any tendency to "snap-off" during the t_b portion of recovery. The HEXFRED features combine to offer designers a rectifier with lower noise and significantly lower switching losses in both the diode and the switching transistor. These HEXFRED advantages can help to significantly reduce snubbing, component count and heatsink sizes. The HEXFRED HFA30TA60C is ideally suited for applications in power supplies and power conversion systems (such as inverters), motor drives, and many other similar applications where high speed, high efficiency is needed.

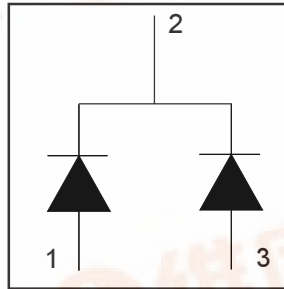

$V_R = 600V$
$V_F(\text{typ.})^* = 1.2V$
$I_{F(AV)} = 15A$
$Q_{rr}(\text{typ.}) = 80nC$
$I_{RRM}(\text{typ.}) = 4.0A$
$t_{rr}(\text{typ.}) = 19ns$
$di_{(rec)M}/dt(\text{typ.})^* = 160A/\mu s$

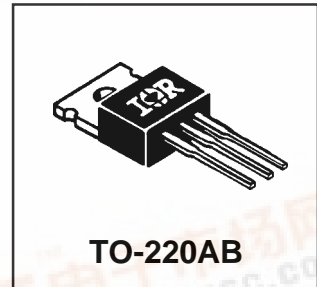

Absolute Maximum Ratings (per Leg)

	Parameter	Max	Units
V_R	Cathode-to-Anode Voltage	600	V
$I_F @ T_C = 25^\circ C$	Continuous Forward Current	15	A
$I_F @ T_C = 100^\circ C$	Continuous Forward Current		
I_{FSM}	Single Pulse Forward Current		
I_{FRM}	Maximum Repetitive Forward Current		
$P_D @ T_C = 25^\circ C$	Maximum Power Dissipation	74	W
$P_D @ T_C = 100^\circ C$	Maximum Power Dissipation	29	
T_J T_{STG}	Operating Junction and Storage Temperature Range	-55 to +150	C

* 125°C



HFA30TA60CPbF

International
IR Rectifier

Electrical Characteristics (per Leg) @ T_J = 25°C (unless otherwise specified)

	Parameter	Min.	Typ.	Max.	Units	Test Conditions
V _{BR}	Cathode Anode Breakdown Voltage	600	---	---	V	I _R = 100μA
V _{FM}	Max Forward Voltage	---	1.3	1.7	V	I _F = 15A
		---	1.5	2.0		I _F = 30A
		---	1.2	1.6		I _F = 15A, T _J = 125°C
I _{RM}	Max Reverse Leakage Current	---	1.0	10	μA	V _R = V _R Rated
		---	400	1000		T _J = 125°C, V _R = 0.8 x V _R Rated
C _T	Junction Capacitance	---	25	50	pF	V _R = 200V
L _S	Series Inductance	---	8	---	nH	Measured lead to lead 5mm from package body

Dynamic Recovery Characteristics (per Leg) @ T_J = 25°C (unless otherwise specified)

	Parameter	Min.	Typ.	Max.	Units	Test Conditions
t _{rr}	Reverse Recovery Time	---	19	---	ns	I _F = 1.0A, di _F /dt = 200A/μs, V _R = 30V
t _{rr1}	See Fig. 5, 10	---	42	60		T _J = 25°C
t _{rr2}		---	70	120		T _J = 125°C
I _{RRM1}	Peak Recovery Current	---	4.0	6.0	A	T _J = 25°C
I _{RRM2}	See Fig. 6	---	6.5	10		T _J = 125°C
Q _{rr1}	Reverse Recovery Charge	---	80	180	nC	T _J = 25°C
Q _{rr2}	See Fig. 7	---	220	600		T _J = 125°C
di _{(rec)M} /dt1	Peak Rate of Fall of Recovery Current	---	250	---	A/μs	T _J = 25°C
di _{(rec)M} /dt2	During t _b See Fig. 8	---	160	---		T _J = 125°C

Thermal - Mechanical Characteristics (per Leg)

	Parameter	Min.	Typ.	Max.	Units
T _{lead} ①	Lead Temperature	---	---	300	°C
R _{thJC}	Junction-to-Case, Single Leg Conducting	---	---	1.7	K/W
	Junction-to-Case, Both Legs Conducting	---	---	0.85	
R _{thJA} ②	Thermal Resistance, Junction to Ambient	---	---	40	
R _{thCS} ③	Thermal Resistance, Case to Heat Sink	---	0.25	---	
Wt	Weight	---	6.0	---	g
		---	0.21	---	(oz)
	Mounting Torque	6.0	---	12	Kg-cm
		5.0	---	10	lbf•in

① 0.063 in. from Case (1.6mm) for 10 sec

② Typical Socket Mount

③ Mounting Surface, Flat, Smooth and Greased

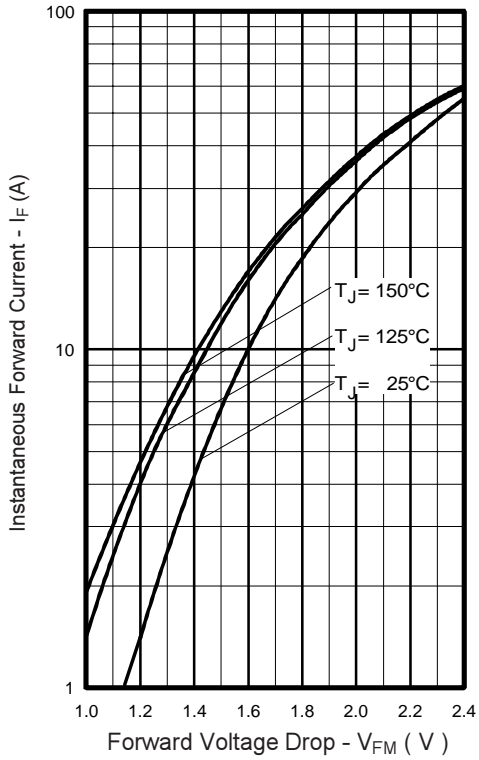

Fig. 1 - Maximum Forward Voltage Drop vs. Instantaneous Forward Current, (per Leg)

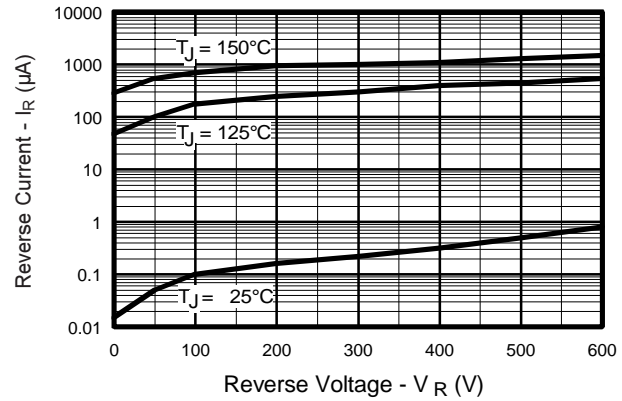

Fig. 2 - Typical Reverse Current vs. Reverse Voltage, (per Leg)

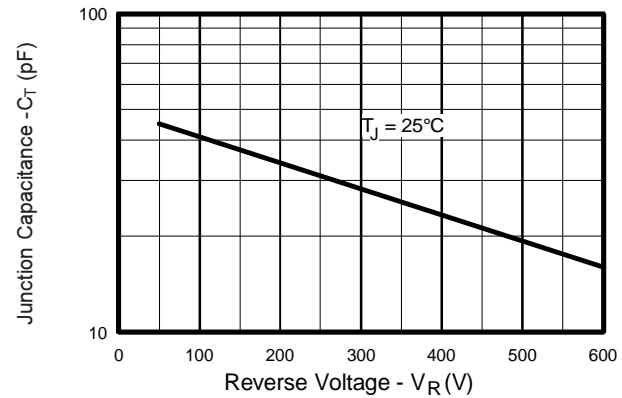

Fig. 3 - Typical Junction Capacitance vs. Reverse Voltage, (per Leg)

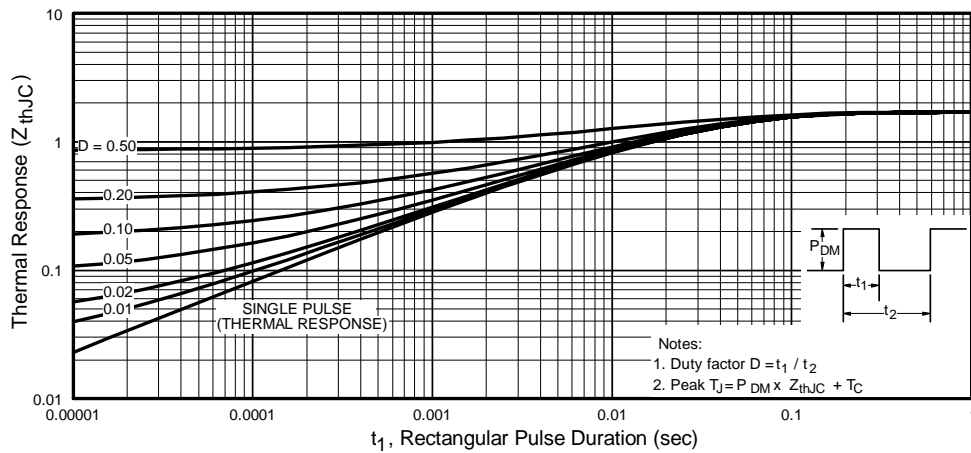

Fig. 4 - Maximum Thermal Impedance Z_{thJC} Characteristics, (per Leg)

HFA30TA60CPbF

International
IR Rectifier

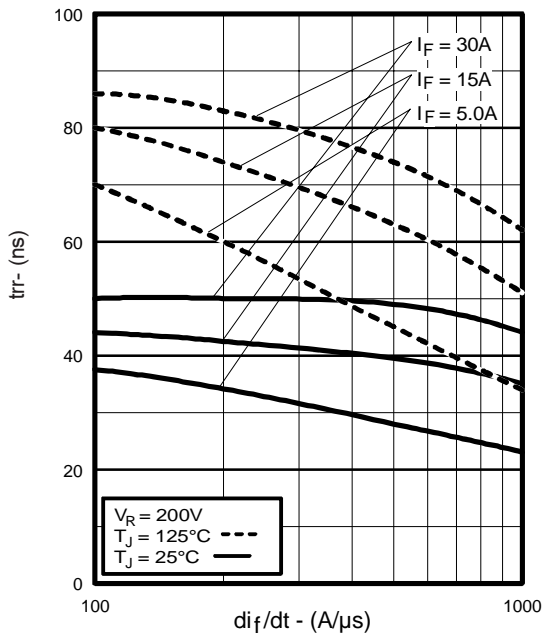

Fig. 5 - Typical Reverse Recovery Time vs. di_f/dt , (per Leg)

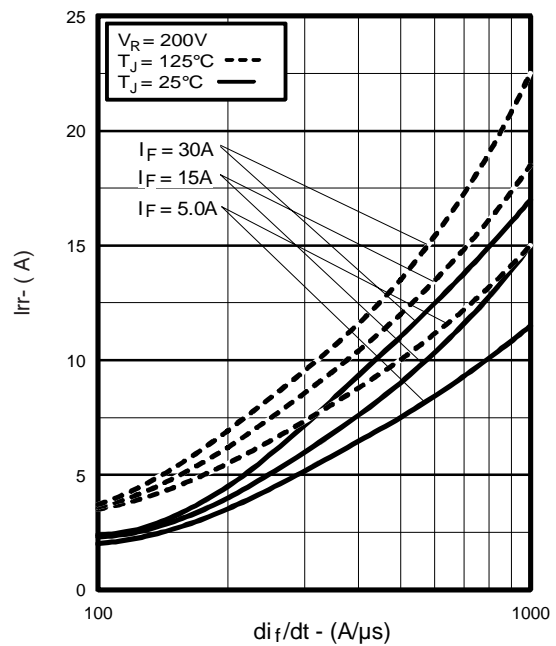

Fig. 6 - Typical Recovery Current vs. di_f/dt , (per Leg)

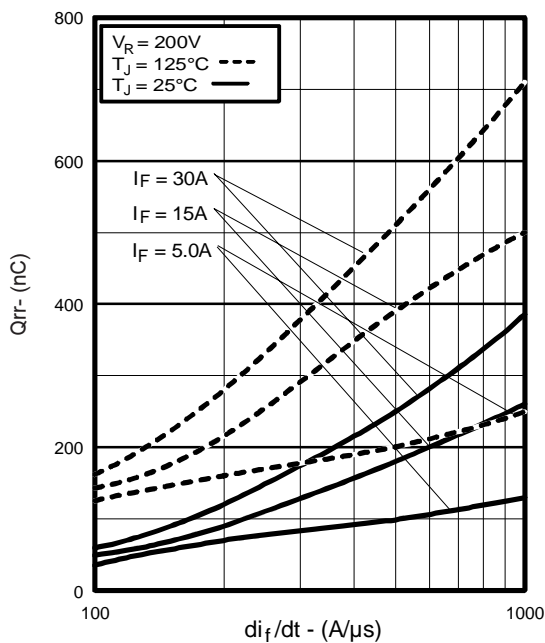

Fig. 7 - Typical Stored Charge vs. di_f/dt , (per Leg)

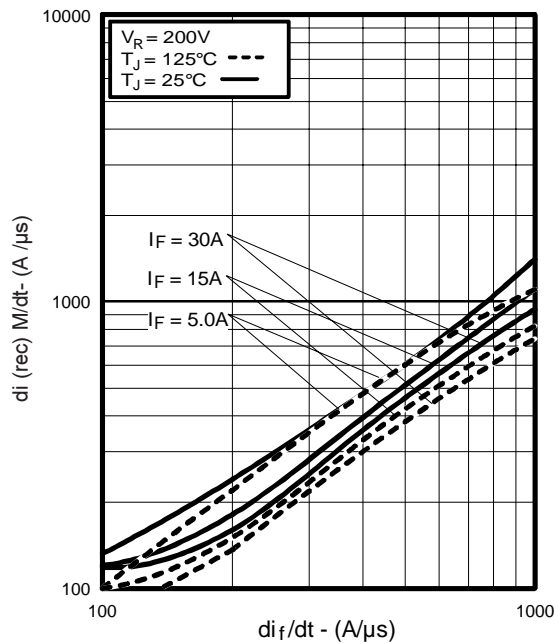

Fig. 8 - Typical $di_{(rec)M}/dt$ vs. di_f/dt , (per Leg)

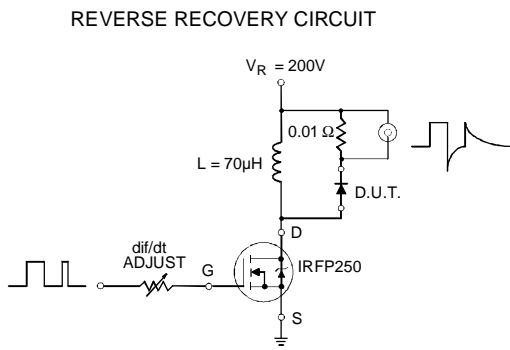

Fig. 9 - Reverse Recovery Parameter Test Circuit

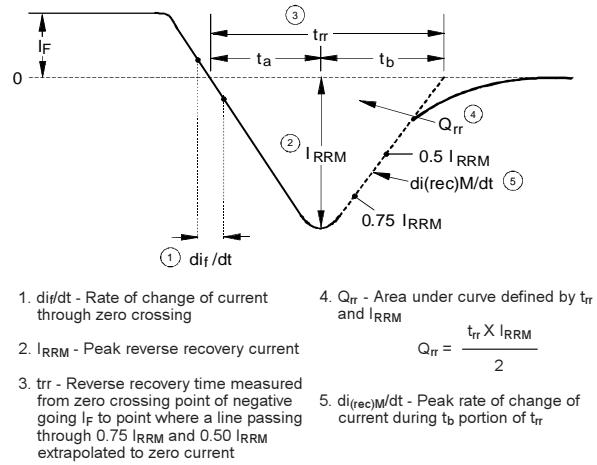

Fig. 10 - Reverse Recovery Waveform and Definitions

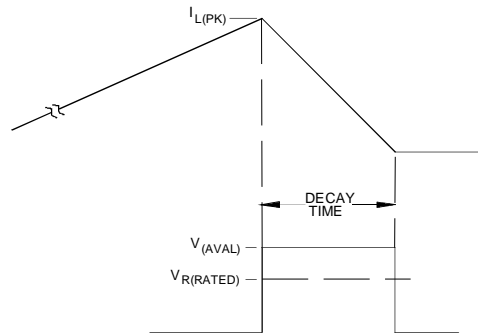
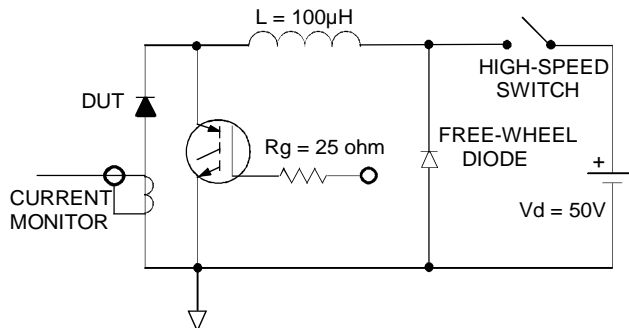

Fig. 11 - Avalanche Test Circuit and Waveforms

HFA30TA60CPbF

International
IR Rectifier

TO-220AB Package Outline

Dimensions are shown in millimeters (inches)

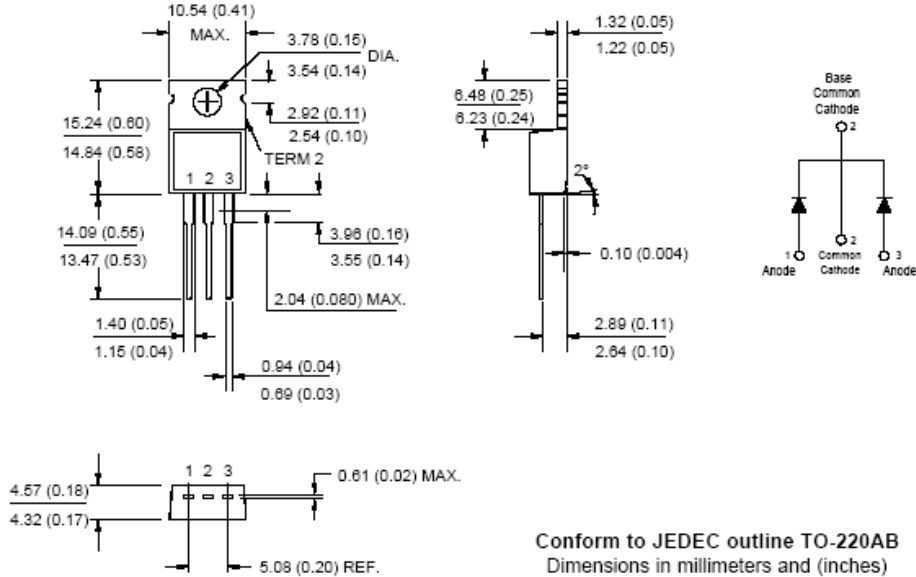

TO-220AB Part Marking Information

EXAMPLE: THIS IS A HFA16TA60C
LOT CODE 1789
ASSEMBLED ON WW 19, 2001
IN THE ASSEMBLY LINE "C"

Note: "P" in the beginning of date code indicates "Lead-Free"

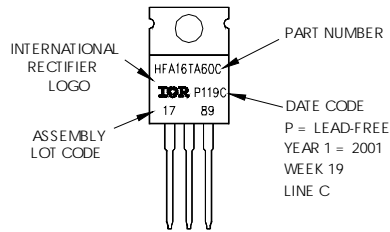

OR

EXAMPLE: THIS IS A HFA16TA60C
LOT CODE 1789
ASSEMBLED ON WW 19, 2001

Note: "P" in assembly line position indicates "Lead-Free"

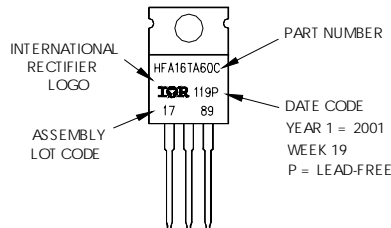

Data and specifications subject to change without notice.

International
IR Rectifier

IR WORLD HEADQUARTERS: 233 Kansas St., El Segundo, California 90245, USA Tel: (310) 252-7105
TAC Fax: (310) 252-7903

Visit us at www.irf.com for sales contact information. 10/04

www.irf.com