

HF2100

MINIATURE HIGH POWER RELAY



File No.:E134517



File No.:R50038042



File No.:EQ125 File No.:CQC02001001955



Features

- 30A switching capability
- PCB coil terminals, ideal for heavy duty load
- 2.5kV dielectric strength (between coil and contacts)
- Wash tight and flux proofed types available
- Class F insulation available
- Environmental friendly product (RoHS compliant)
- Outline Dimensions: (32.2 x 27.5 x 28.0) mm

CONTACT DATA

Contact arrangement	1A	1B	1C (NO)	1C (NC)
Contact resistance	50mΩ (at 1A, 6VDC)			
Contact material	AgCdO			
Contact rating (Res. load)	30A 240VAC 20A 30VDC	15A 240VAC 10A 30VDC	20A 240VAC 20A 30VDC	10A 240VAC 10A 30VDC
Max. switching capacity	7200VA 600W	3600VA 300W	4800VA 600W	2400VA 300W
Max. switching voltage	277VAC / 30VDC			
Max. switching current	40A	15A	20A	10A
Mechanical endurance	1 x 10 ⁷ OPS			
Electrical endurance	1 x 10 ⁵ OPS			

COIL

Coil power	900mW
------------	-------

COIL DATA

at 23°C

Nominal Voltage VDC	Pick-up Voltage VDC	Drop-out Voltage VDC	Max. Allowable Voltage VDC	Coil Resistance Ω
5	3.75	0.5	6.5	27 x (±10%)
6	4.50	0.6	7.8	40 x (±10%)
9	6.75	0.9	11.7	97 x (±10%)
12	9.00	1.2	15.6	155 x (±10%)
15	11.25	1.5	19.5	256 x (±10%)
18	13.50	1.8	23.4	380 x (±10%)
24	18.00	2.4	31.2	660 x (±10%)
48	36.00	4.8	62.4	2560 x (±10%)
70	52.50	7.0	91.0	5500 x (±10%)
110	82.50	11.0	143.0	13450 x (±10%)

CHARACTERISTICS

Insulation resistance	1000MΩ (at 500VDC)	
Dielectric strength	Between coil & contacts	2500VAC 1min
	Between open contacts	1500VAC 1min
Operate time (at nomi. volt.)	15ms max.	
Release time (at nomi. volt.)	10ms max.	
Ambient temperature	Class B	-55°C to 100°C
	Class F	-55°C to 125°C
Shock resistance	Functional	100m/s ² (10g)
	Destructive	1000m/s ² (100g)
Vibration resistance	10Hz to 55Hz 1.5mm DA	
Humidity	98% RH, 40°C	
Termination	PCB & QC	
Unit weight	Approx. 35g	
Construction	Wash tight, Flux proofed	

Notes: 1) The data shown above are initial values.
2) Please find coil temperature curve in the characteristic curves below.



HONGFA RELAY

ISO9001、ISO/TS16949、ISO14001、OHSAS18001 CERTIFIED

2007 Rev. 2.01

SAFETY APPROVAL RATINGS

UL&CUR

Load type	Volts	1 Form A	1 Form B	1 Form C (NO)	1 Form C (NO)
General purpose	125/240VAC	30A	15A	--	15A
	277VAC	30A	30A	30A	30A
Resistive	125/240VAC	30A	15A	--	--
	30VDC	20A	10A	20A	10A
	277VAC	20A	--	--	--
	240VAC	15A	--	--	--
Ballast	125/240/277VAC	6A	3A	6A	3A
Pilot duty	125VAC	800VA	290VA	800VA	290VA
	125VAC	690VA	--	690VA	--
	125VAC	800VA	--	800VA	--
	240VAC	1152VA	768VA	1152VA	768VA
	277VAC	764VA	--	764VA	--
Motor load	125VAC	1HP	1/4HP	1HP	1/4HP
	240VAC	2HP	1HP	2HP	1HP
	125VAC	1HP	--	1HP	--
	125/277VAC	3/4HP	--	3/4HP	--
Definite purpose (LRA-loaded rotor) (FLA-full load)	120VAC	82.8LRA, 13.8FLA	--	82.8LRA, 13.8FLA	--
	125VAC	96LRA, 30FLA	33LRA, 10FLA	60LRA, 20FLA	33LRA, 10FLA
	125VAC	60LRA, 20FLA	30LRA, 12FLA	60LRA, 20FLA	30LRA, 12FLA
	125VAC	82.8LRA, 27FLA	--	82.8LRA, 27FLA	--
	240VAC	80LRA, 30FLA	33LRA, 10FLA	80LRA, 20FLA	33LRA, 10FLA
	240VAC	41.4LRA, 6.9FLA	--	41.48LRA, 6.9FLA	--
	277VAC	60LRA, 20FLA	--	60LRA, 20FLA	--
Tungsten	125VAC	15A	--	15A	--
	240VAC	5A	--	5A	3A
	120VAC	--	3A	--	--
	240VAC	--	3A	--	--

Notes: Only some typical ratings are listed above. If more details are required, please contact us.

ORDERING INFORMATION

Type	HF2100	-1A	-12D	E	F	(XXX)
Contact arrangement	1A: 1Form A	1B: 1Form B	1C: 1Form C			
Coil voltage	5, 6, 9, 12, 15, 18, 24, 48, 70, 110VDC					
Construction¹⁾	E: Wash tight		Nil: Flux proofed			
Insulation standard	F: Class F		Nil: Class B			
Customer special code²⁾ (Only for special requirements)	e.g. (551) stands for RoHS compliant (Cadmium containing contacts) (555) stands for RoHS compliant (Cadmium-free contacts)					

Notes: 1) Under the ambience with dangerous gas like H₂S, SO₂ or NO₂, wash tight type is recommended; please test the relay in real applications. If the ambience allows, flux proofed is preferentially recommended.

2) HF2100 is an environmental friendly product. Please mark a special code (555) or (551) when ordering. (551) stands RoHS compliant with Cadmium contact; (555) stands for RoHS compliant with Cadmium-free contact.

OUTLINE DIMENSIONS, WIRING DIAGRAM AND PC BOARD LAYOUT

Unit: mm

1 Form A

Outline Dimensions

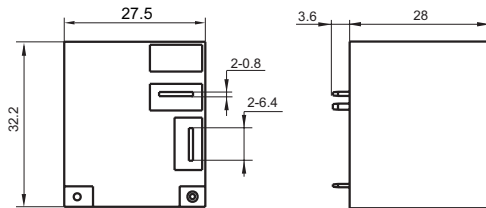

Wiring Diagram

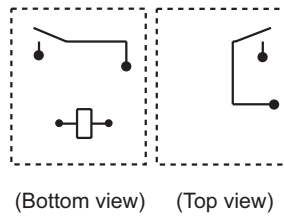

PCB Layout
(Bottom view)

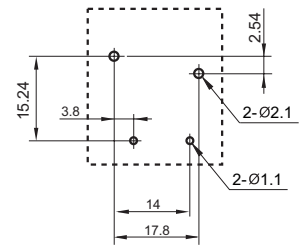

1 Form B

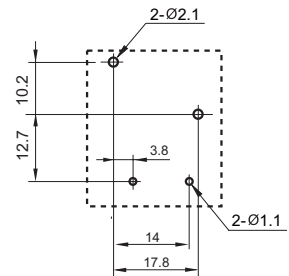
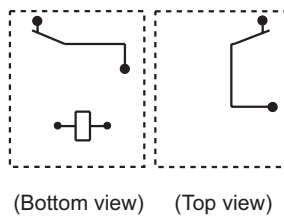
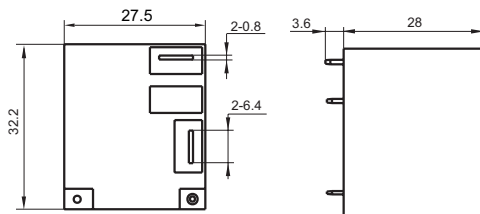

1 Form C

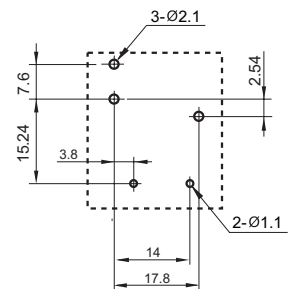
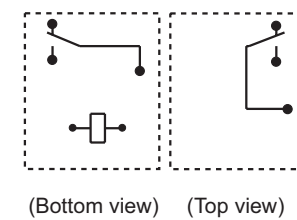
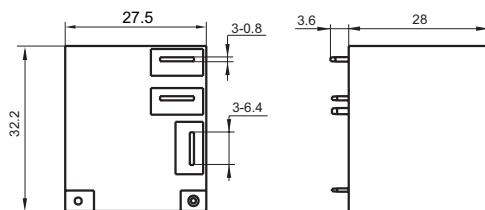

- Remark: 1) In case of no tolerance shown in outline dimension: outline dimension $\leq 1\text{mm}$, tolerance should be $\pm 0.2\text{mm}$; outline dimension $> 1\text{mm}$ and $\leq 5\text{mm}$, tolerance should be $\pm 0.3\text{mm}$; outline dimension $> 5\text{mm}$, tolerance should be $\pm 0.4\text{mm}$.
 2) The tolerance without indicating for PCB layout is always $\pm 0.1\text{mm}$.

CHARACTERISTIC CURVES

COIL TEMPERATURE RISE

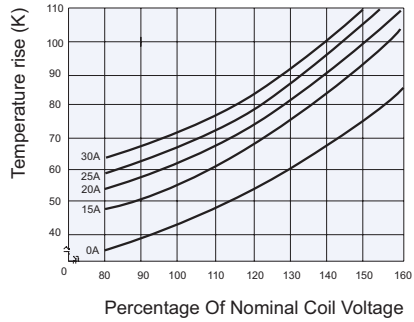

MAXIMUM SWITCHING POWER

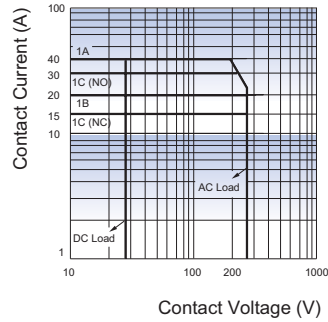

ENDURANCE CURVE

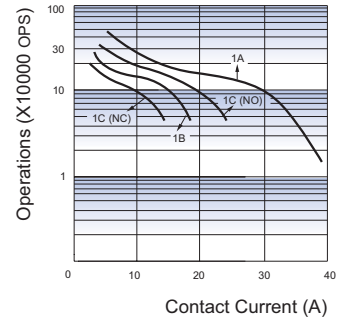

Disclaimer

This datasheet is for the customers' reference. All the specifications are subject to change without notice.

We could not evaluate all the performance and all the parameters for every possible application. Thus the user should be in a right position to choose the suitable product for their own application. If there is any query, please contact Hongfa for the technical service. However, it is the user's responsibility to determine which product should be used only.