



HMC-C025

0.5dB LSB GaAs MMIC 6-BIT DIGITAL ATTENUATOR MODULE, DC - 13 GHz



Typical Applications

The HMC-C025 is ideal for:

- Telecom Infrastructure
- Military Radio, Radar & ECM
- Space Systems
- Test Instrumentation

Functional Diagram

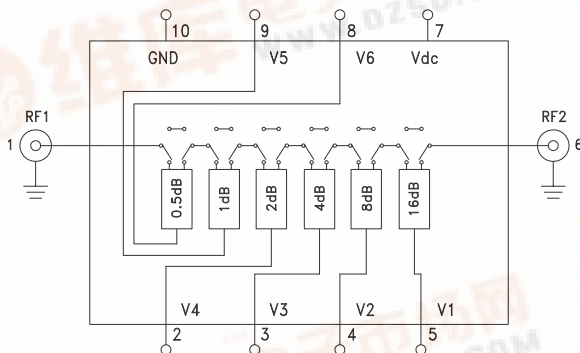

Features

- 0.5 dB LSB Steps to 31.5 dB
- Single Control Line Per Bit
- ± 0.3 dB Typical Bit Error
- CMOS Compatible Control
- Hermetically Sealed Module
- Field Replaceable SMA Connectors
- -55 to +85 C Operating Temperature

General Description

The HMC-C025 is a DC to 13 GHz 6-bit GaAs IC Digital Attenuator housed in a miniature hermetic module. This wideband attenuator features 4 dB typical insertion loss, +38 dBm input IP3, and bit values of 0.5 (LSB), 1, 2, 4, 8, and 16 dB for a total attenuation of 31.5 dB. Attenuation accuracy is excellent with ±0.3 dB typical step error. Six control voltage inputs, toggled between 0 and +5V, are used to select each attenuation state. A single Vdc bias of -5V allows operation at frequencies down to DC. Removable SMA connectors can be detached to allow direct connection of the module's I/O pins to a microstrip or coplanar circuit.

Electrical Specifications, $T_A = +25^\circ C$, with $V_{dc} = -5V$ & $V_{CTL} = 0/+5V$

Parameter	Frequency (GHz)	Min.	Typ.	Max.	Units
Insertion Loss	DC - 4.0 GHz		3.2	3.7	dB
	4.0 - 8.0 GHz		4.2	4.7	dB
	8.0 - 11.0 GHz		5.0	5.5	dB
	11.0 - 13.0 GHz		5.5	6.0	dB
Attenuation Range	DC - 13.0 GHz		31.5		dB
Return Loss (RF1 & RF2, All Atten. States)	DC - 13.0 GHz		12		dB
Attenuation Accuracy: (Referenced to Insertion Loss) All States	DC - 3.0 GHz	± (0.2 + 3% of Atten. Setting) Max			dB
	3.0 - 10.0 GHz	± (0.4 + 3% of Atten. Setting) Max			dB
	3.0 - 10.0 GHz	± (0.4 + 4% of Atten. Setting) Max			dB
	10.0 - 13.0 GHz	± (0.6 + 6% of Atten. Setting) Max			dB
Input Power for 0.1 dB Compression	1.0 - 13.0 GHz		22		dBm
Input Third Order Intercept Point (Two-Tone Input Power = 0 dBm Each Tone)	1.0 - 13.0 GHz	RF State	46		dBm
		All Other States	38		dBm
Switching Characteristics	DC - 13.0 GHz				
tRISE, tFALL (10/90% RF)			22		ns
tON/tOFF (50% CTL to 10/90% RF)			45		ns



0.5dB LSB GaAs MMIC 6-BIT DIGITAL ATTENUATOR MODULE, DC - 13 GHz

Insertion Loss

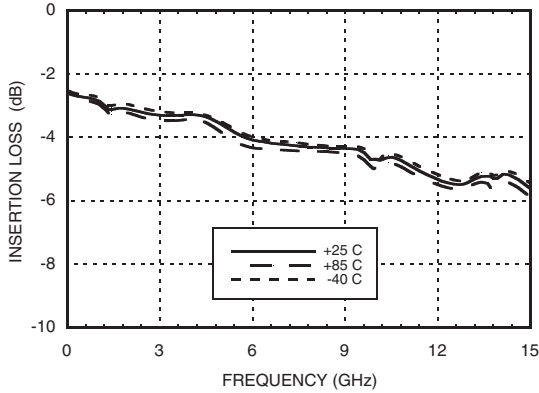

Return Loss RF1, RF2
(Only Major States are Shown)

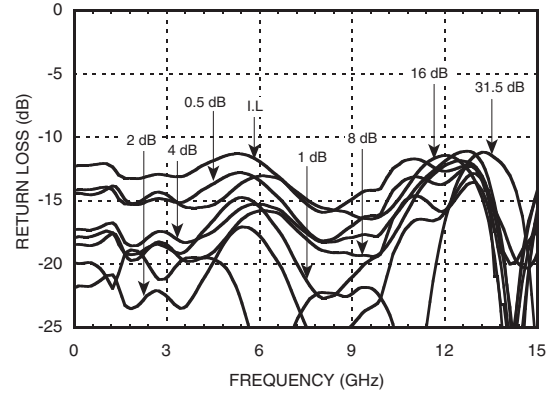

Normalized Attenuation
(Only Major States are Shown)

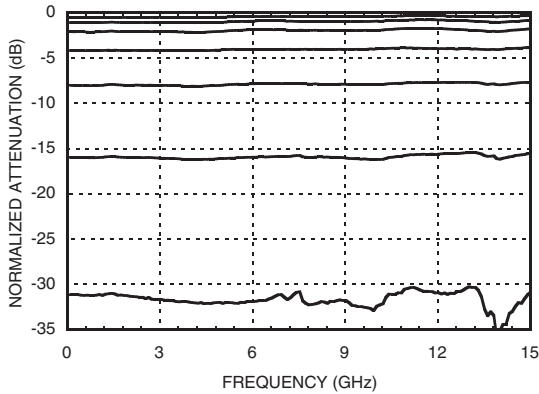

Bit Error vs. Attenuation State

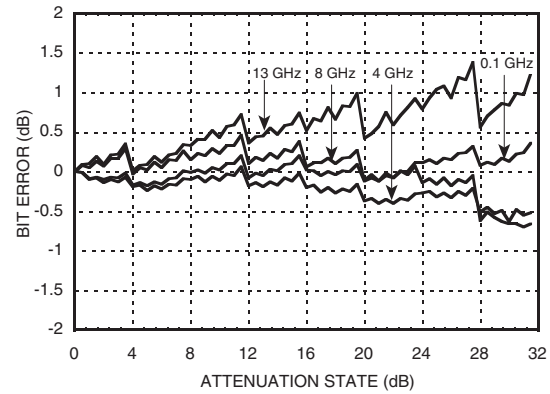

Bit Error vs. Frequency
(Only Major States are Shown)

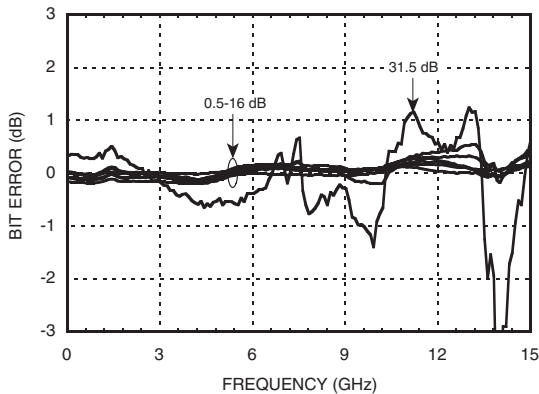

Relative Phase vs. Frequency
(Only Major States are Shown)

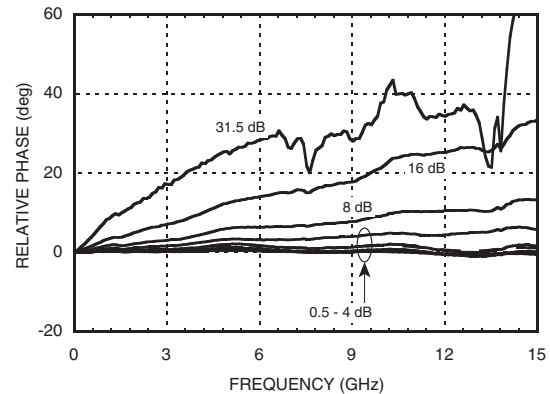

0.5dB LSB GaAs MMIC 6-BIT DIGITAL ATTENUATOR MODULE, DC - 13 GHz

Worst Case Step Error Between Successive Attenuation States

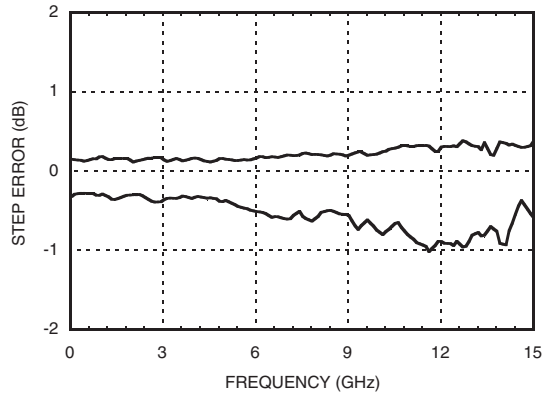

Bias Voltage & Current

Vdc Range= -5 Vdc ± 10%		
Vdc	I _{dc} (Typ.) (mA)	I _{dc} (Max.) (mA)
-5.0	5	9

(Bias current increases with switching rate to 15 - 20 mA)

Control Voltage (CMOS Compatible)

State	Bias Condition
Low	0 to +1.5V @ 5 µA Typ.
High	+3.5 to +5.0V @ 800 µA Typ.

Truth Table

Control Voltage Input						Attenuation State RF1 - RF2
V1 16 dB	V2 8 dB	V3 4 dB	V4 2 dB	V5 1 dB	V6 0.5 dB	
Low	Low	Low	Low	Low	Low	Reference I.L.
Low	Low	Low	Low	Low	High	0.5 dB
Low	Low	Low	Low	High	Low	1 dB
Low	Low	Low	High	Low	Low	2 dB
Low	Low	High	Low	Low	Low	4 dB
Low	High	Low	Low	Low	Low	8 dB
High	Low	Low	Low	Low	Low	16 dB
High	High	High	High	High	High	31.5 dB

Any combination of the above states will provide an attenuation approximately equal to the sum of the bits selected.

Absolute Maximum Ratings

Control Voltage (V1 to V6)	-0.5V to +5.5V
Bias Voltage (Vdc)	-7 Vdc
Storage Temperature	-65 to + 150 °C
Operating Temperature	-55 to +85 °C
RF Input Power (0.5 - 13.0 GHz)	+25 dBm



ELECTROSTATIC SENSITIVE DEVICE
OBSERVE HANDLING PRECAUTIONS

**0.5dB LSB GaAs MMIC 6-BIT DIGITAL
ATTENUATOR MODULE, DC - 13 GHz**

Outline Drawing

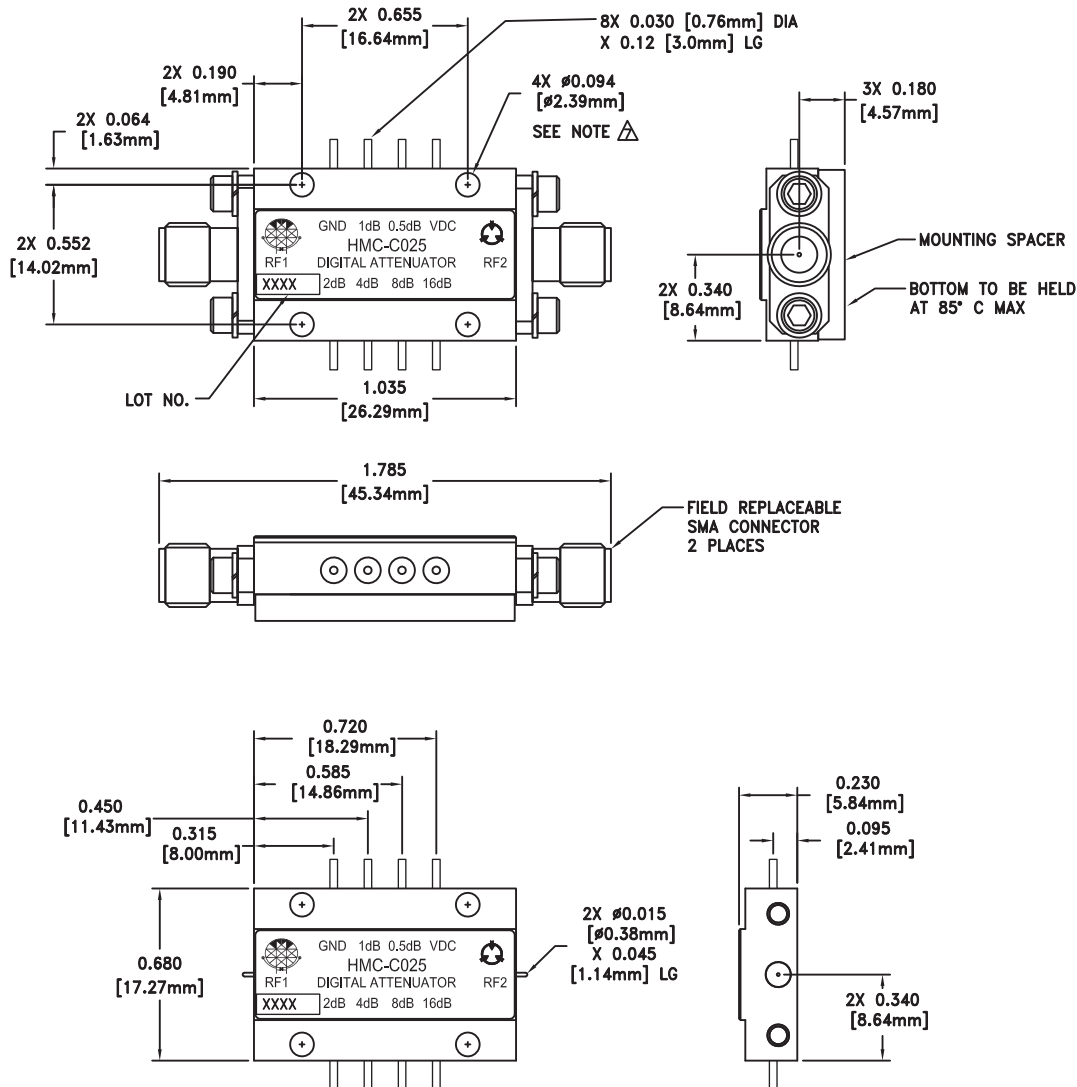

Package Information

Package Type	C-6
Package Weight ^[1]	17.4 gms ^[2]
Spacer Weight	3 gms ^[2]

[1] Includes the connectors

[2] ±1 gms Tolerance

NOTES:

1. PACKAGE, LEADS, COVER MATERIAL: KOVAR™
 2. SPACER MATERIAL: ALUMINUM
 3. PLATING: ELECTROLYTIC GOLD 50 MICROINCHES MIN., OVER ELECTROLYTIC NICKEL 75 MICROINCHES MIN.
 4. ALL DIMENSIONS ARE IN INCHES [MILLIMETERS].
 5. TOLERANCES ±.005 [0.13] UNLESS OTHERWISE SPECIFIED.
 6. FIELD REPLACEABLE SMA CONNECTORS. TENSOLITE 5602 - 5CCSF OR EQUIVALENT.
- ▲ MOUNT MODULE TO SYSTEM PLATFORM WITH #2-56 HARDWARE

Pin Description

Pin Number	Function	Description	Interface Schematic
1	RF1	This pin is DC coupled and matched to 50 Ohms. Blocking capacitors are required if RF line potential is not equal to 0 Vdc.	
5, 4, 3, 2, 9, 8	V1 - V6	See truth table and control voltage table.	
6	RF2	This pin is DC coupled and matched to 50 Ohms. Blocking capacitors are required if RF line potential is not equal to 0 Vdc.	
7	Vdc	Supply voltage: -5 Vdc ±10%.	
10	GND	Power Supply Ground	



HMC-C025

**0.5dB LSB GaAs MMIC 6-BIT DIGITAL
ATTENUATOR MODULE, DC - 13 GHz**