

# HMC543

## 22.5° MMIC 4-BIT DIGITAL PHASE SHIFTER, 8 - 12 GHz

### Typical Applications

The HMC543 is ideal for:

- EW Receivers
- Weather & Military Radar
- Satellite Communications
- Beamforming Modules

### Features

- Low RMS Phase Error: 5°
- Low Insertion Loss: 6.5 dB
- Excellent Flatness
- 360° Coverage, LSB = 22.5°
- Die Size: 0.99 x 2.46 x 0.1 mm

### Functional Diagram

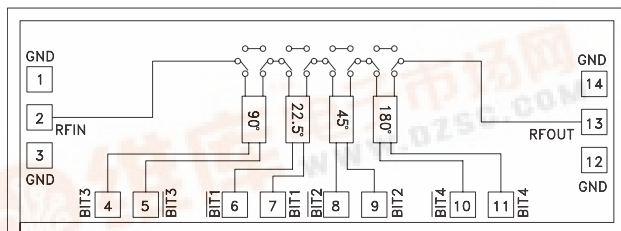

### General Description

The HMC543 is a 4-bit digital phase shifter die which is rated from 8 to 12 GHz, providing 0 to 360 degrees of phase coverage, with a LSB of 22.5 degrees. The HMC543 features very low RMS phase error of 5 degrees and extremely low insertion loss variation of  $\pm 0.8$  dB across all phase states. This high accuracy phase shifter is controlled with complementary logic of 0/-3V, and requires no fixed bias voltage and is internally matched to 50 Ohms with no external components. Simple external level shifting circuitry can be used to convert a positive CMOS control voltage into complementary negative control signals.

### Electrical Specifications, $T_A = +25^\circ C$ , 50 Ohm System, Control Voltage = 0/-3V

Parameter	Min.	Typ.	Max.	Units
Frequency Range	8		12	GHz
Insertion Loss*		5	7	dB
Input Return Loss*		10		dB
Output Return Loss*		10		dB
Phase Error*		$\pm 10$	$\pm 15$	deg
RMS Phase Error		5		deg
Gain Variation*		$\pm 0.8$		dB
Input Power for 1 dB Compression	21	24.5		dBm
Input Third Order Intercept		40		dBm
Control Voltage Current		<2		mA

\*Note: All States Shown



**22.5° MMIC 4-BIT DIGITAL  
PHASE SHIFTER, 8 - 12 GHz**

**Insertion Loss, All States**

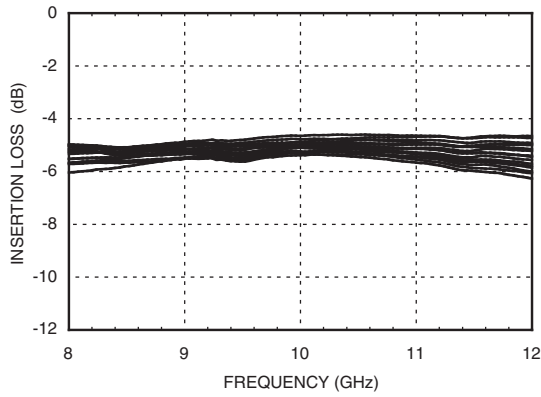

**Normalized Loss, All States**

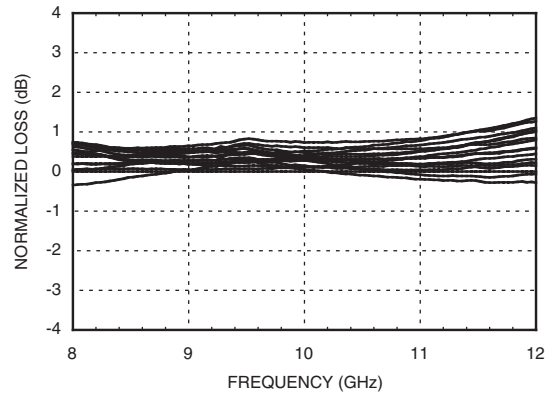

**Input Return Loss, All States**

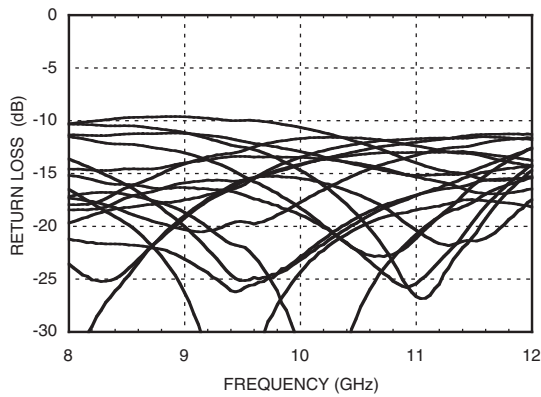

**Phase Error, All States**

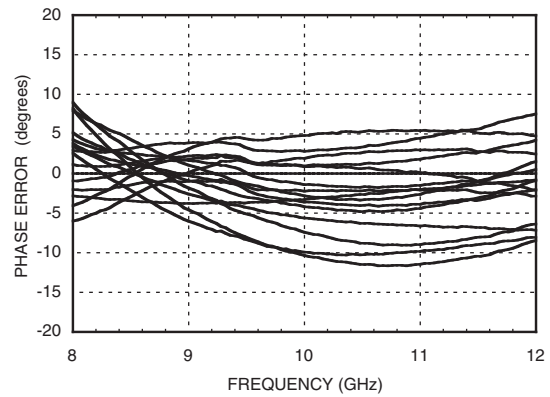

**Output Return Loss, All States**

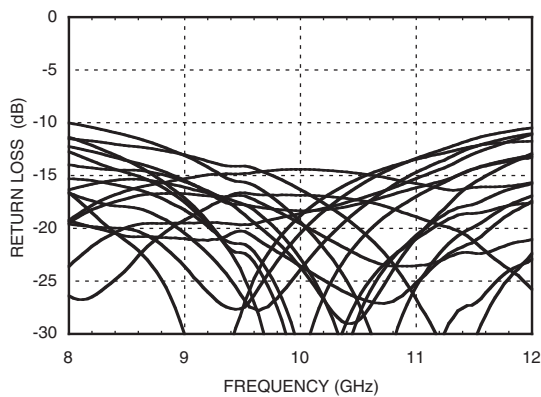

**Relative Phase Shift, All States**

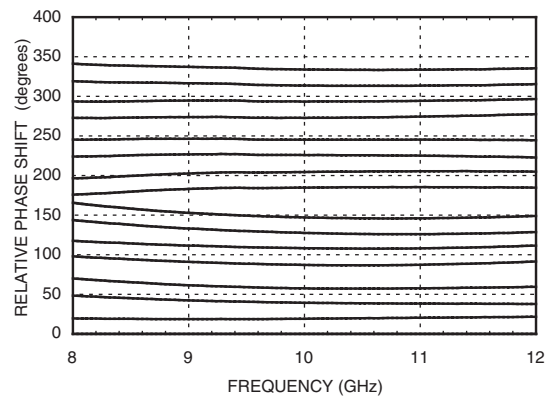

**22.5° MMIC 4-BIT DIGITAL  
PHASE SHIFTER, 8 - 12 GHz**

**Relative Phase Shift,  
RMS, Average, Max, All States**

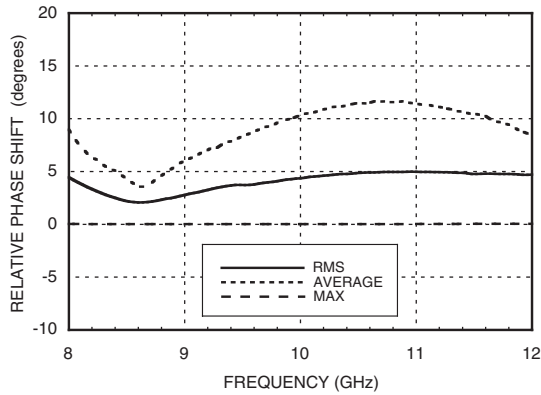

**Input IP3, All States**

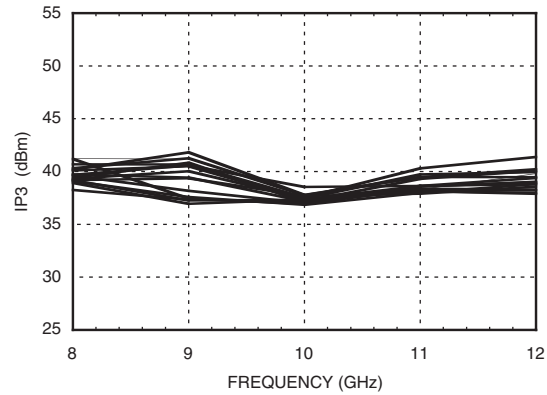

**Input IP2, All States**

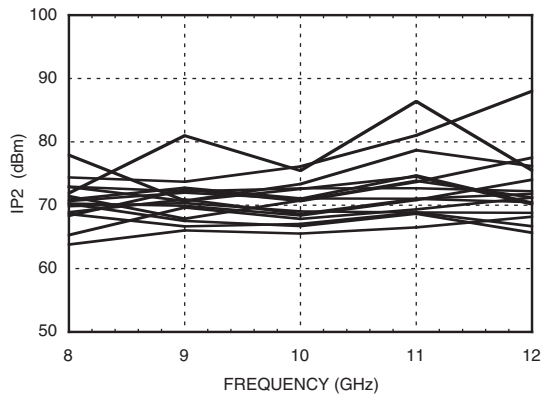

**Input P1dB, All States**

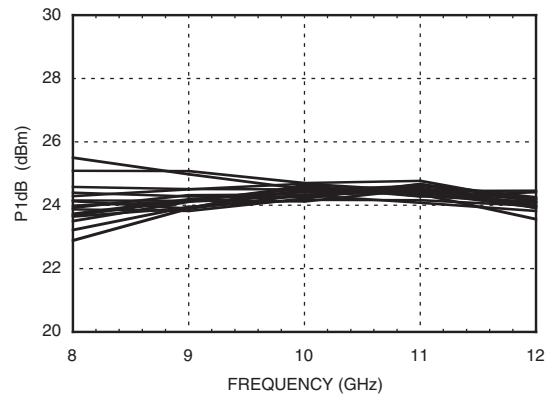

**RMS Phase Error vs. Temperature**

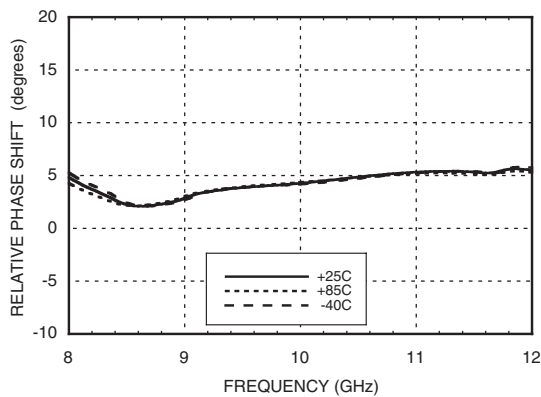

**Maximum Insertion Loss vs. Temperature**

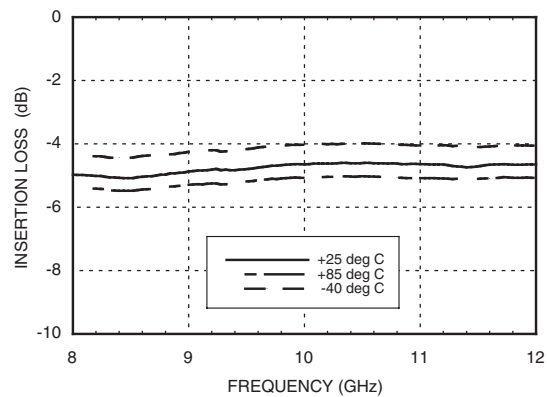

**22.5° MMIC 4-BIT DIGITAL  
PHASE SHIFTER, 8 - 12 GHz**

**Phase Error vs. State**

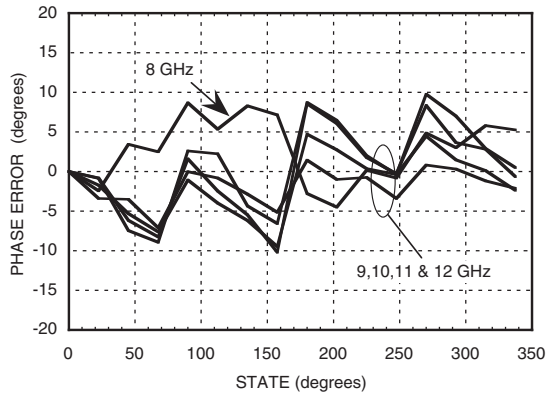

**Absolute Maximum Ratings**

Input Power (RFin) (8-12 GHz)	+27 dBm (T= +85 °C)
Channel Temperature (Tc)	150 °C
Thermal Resistance (channel to die bottom)	130 °C/W
Storage Temperature	-65 to +150 °C
Operating Temperature	-40 to +85 °C

**Control Voltage**

State	Bias Condition
Low (0)	-2.5 to -3.5V @ 0.4 μA Typ.
High (1)	0 to +0.3V @ 0.4 μA Typ.



**ELECTROSTATIC SENSITIVE DEVICE  
OBSERVE HANDLING PRECAUTIONS**

**Truth Table**

Control Voltage Input								Phase Shift (Degree) RFIN - RFOUT
Bit 1	$\overline{\text{Bit 1}}$	Bit 2	$\overline{\text{Bit 2}}$	Bit 3	$\overline{\text{Bit 3}}$	Bit 4	$\overline{\text{Bit 4}}$	
0	1	0	1	0	1	0	1	Reference
1	0	0	1	0	1	0	1	22.5
0	1	1	0	0	1	0	1	45.0
0	1	0	1	1	0	0	1	90.0
0	1	0	1	0	1	1	0	180.0
1	0	1	0	1	0	1	0	337.5

Any combination of the above states will provide a phase shift approximately equal to the sum of the bits selected.

**22.5° MMIC 4-BIT DIGITAL  
PHASE SHIFTER, 8 - 12 GHz**

**Outline Drawing**

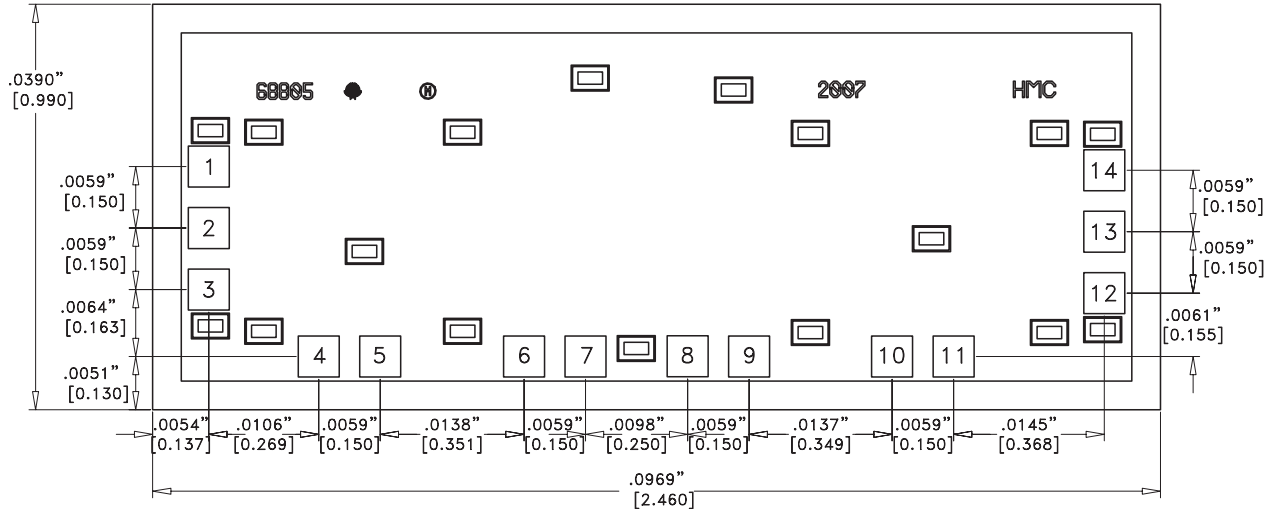

**Die Packaging Information [1]**

Standard	Alternate
GP-2	[2]

[1] Refer to the "Packaging Information" section for die packaging dimensions.



[2] For alternate packaging information contact Hittite Microwave Corporation.

NOTES:

1. ALL DIMENSIONS IN INCHES (MILLIMETERS)
2. DIE THICKNESS IS 0.007
3. TYPICAL BOND PAD IS 0.004 SQUARE
4. BACKSIDE METALLIZATION: GOLD
5. BACKSIDE METAL IS GROUND
6. BOND PADS METALLIZATION: GOLD
7. NO CONNECTION REQUIRED FOR UNLABELED BOND PADS
8. OVERALL DIE SIZE  $\pm 0.002$

## 22.5° MMIC 4-BIT DIGITAL PHASE SHIFTER, 8 - 12 GHz

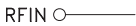
### Pad Descriptions

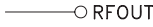
Pad Number	Function	Description	Interface Schematic
1, 3, 12, 14	GND	These pins and die bottom must be connected to RF/DC ground.	
2	RFIN	This port is matched to 50 Ohms.	
4, 7, 9, 11	BIT3, BIT1, BIT2, BIT4	Non-Inverted Control Input. See truth table and control voltage tables.	
5, 6, 8, 10	$\overline{\text{BIT3}}, \overline{\text{BIT1}}$ $\overline{\text{BIT2}}, \overline{\text{BIT4}}$	Inverted Control Input. See truth table and control voltage tables.	
13	RFOUT	This port is matched to 50 Ohms.	

### Application Circuit

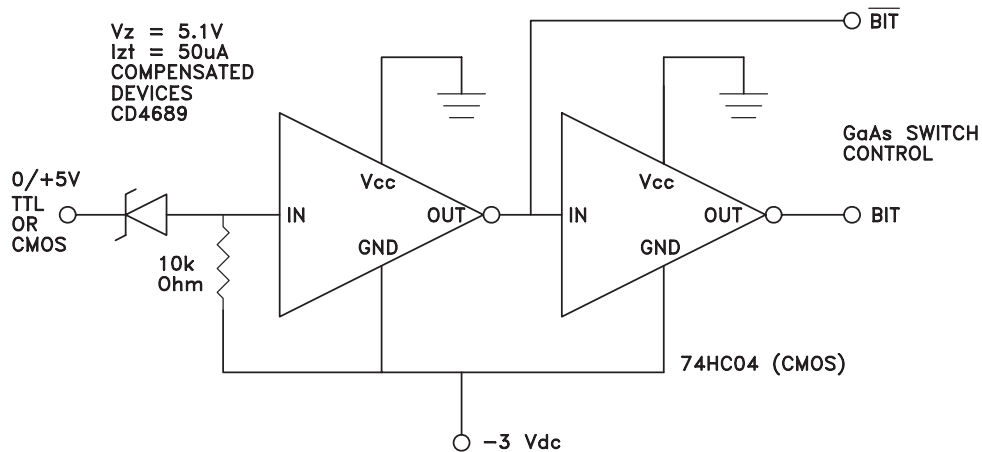

**22.5° MMIC 4-BIT DIGITAL  
PHASE SHIFTER, 8 - 12 GHz**

**Assembly Diagram**

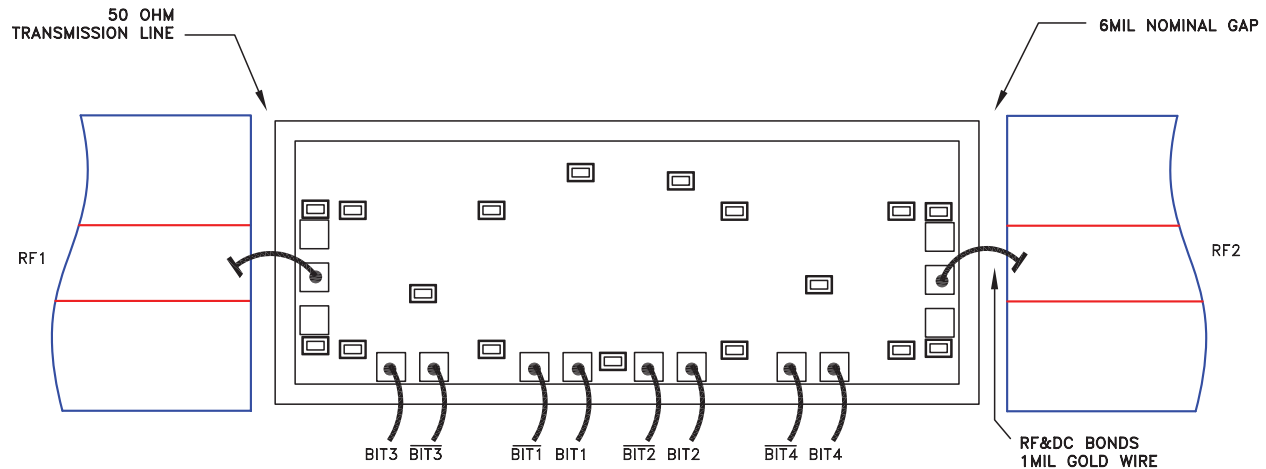

**Handling Precautions**

Follow these precautions to avoid permanent damage.

**Storage:** All bare die are placed in either Waffle or Gel based ESD protective containers, and then sealed in an ESD protective bag for shipment. Once the sealed ESD protective bag has been opened, all die should be stored in a dry nitrogen environment.

**Cleanliness:** Handle the chips in a clean environment. DO NOT attempt to clean the chip using liquid cleaning systems.

**Static Sensitivity:** Follow ESD precautions to protect against  $\pm 250V$  ESD strikes.

**Transients:** Suppress instrument and bias supply transients while bias is applied. Use shielded signal and bias cables to minimize inductive pick-up.

**General Handling:** Handle the chip along the edges with a vacuum collet or with a sharp pair of bent tweezers. The surface of the chip has fragile air bridges and should not be touched with vacuum collet, tweezers, or fingers.

**Mounting**

The chip is back-metallized and can be die mounted with electrically conductive epoxy. The mounting surface should be clean and flat.

**Epoxy Die Attach:** Apply a minimum amount of epoxy to the mounting surface so that a thin epoxy fillet is observed around the perimeter of the chip once it is placed into position. Cure epoxy per the manufacturer's schedule.

**Wire Bonding**

Ball or wedge bond with 0.025mm (1 mil) diameter pure gold wire. Thermosonic wirebonding with a nominal stage temperature of 150 deg. C and a ball bonding force of 40 to 50 grams or wedge bonding force of 18 to 22 grams is recommended. Use the minimum level of ultrasonic energy to achieve reliable wirebonds. Wirebonds should be started on the chip and terminated on the package or substrate. All bonds should be as short as possible  $< 0.31mm$  (12 mils).

**22.5° MMIC 4-BIT DIGITAL  
PHASE SHIFTER, 8 - 12 GHz**

**Notes**