



HMC608

GaAs PHEMT MEDIUM POWER AMPLIFIER, 9.5 - 11.5 GHz

Typical Applications

The HMC608 is ideal for:

- Point-to-Point Radios
- Point-to-Multi-Point Radios
- Military End-Use

Features

- Output IP3: +33 dBm
- Saturated Power: +27.5 dBm @ 23% PAE
- Gain: 32 dB
- Supply: +5V @ 310 mA
- 50 Ohm Matched Input/Output
- 2.1 x 1.2 x 0.1 mm Die Size

Functional Diagram

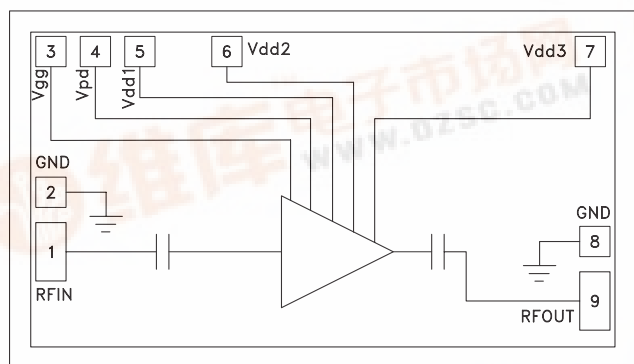

General Description

The HMC608 is a high dynamic range GaAs PHEMT MMIC Medium Power Amplifier chip. The amplifier has two modes of operation: high gain mode (Vpd pin shorted to ground); and low gain mode (Vpd pin left open). The electrical specifications in the table below are shown for the amplifier operating in high gain mode. Operating from 9.5 to 11.5 GHz, the amplifier provides 32 dB of gain, +27.5 dBm of saturated power and 23% PAE from a +5.0 V supply voltage. Noise figure is 5.5 dB while output IP3 is +33 dBm. The RF I/Os are DC blocked and matched to 50 Ohms for ease of use.

Electrical Specifications, $T_A = +25^\circ C$, $V_{dd1, 2, 3} = 5V$, $I_{dd} = 310 mA$ [1], $V_{pd} = GND$ [2]

Parameter	Min.	Typ.	Max.	Units
Frequency Range		9.5 - 11.5		GHz
Gain [3]	28	32		dB
Gain Variation Over Temperature		0.02	0.03	dB/°C
Input Return Loss		12		dB
Output Return Loss		20		dB
Output Power for 1 dB Compression (P1dB)	23	27		dBm
Saturated Output Power (Psat)		27.5		dBm
Output Third Order Intercept (IP3)		33		dBm
Noise Figure		5.5		dB
Supply Current ($I_{dd} = I_{dd1} + I_{dd2} + I_{dd3}$) ($V_{dd} = +5V$, $V_{gg} = -2.6V$ Typ.) [3]		310	350	mA

[1] Adjust Vgg between -3 to 0V to achieve $I_{dd} = 310 mA$ typical.

[2] $V_{pd} = GND$ for high gain mode, $V_{pd} = OPEN$ for low gain mode.

[3] In low gain mode, typical gain is 22 dB and typical current is 67 mA.

**GaAs PHEMT MEDIUM
POWER AMPLIFIER, 9.5 - 11.5 GHz**

Broadband Gain & Return Loss

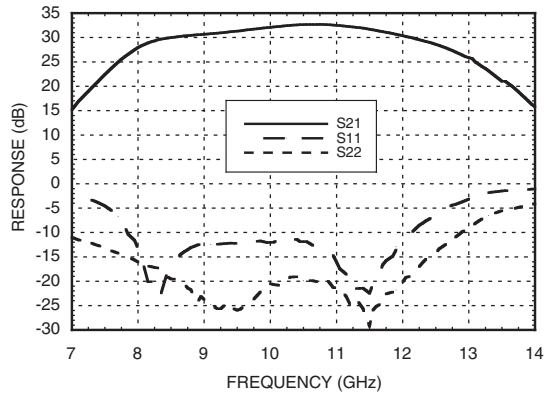

Gain vs. Temperature

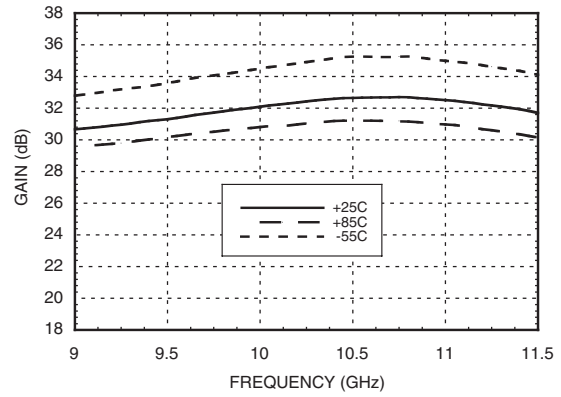

Input Return Loss vs. Temperature

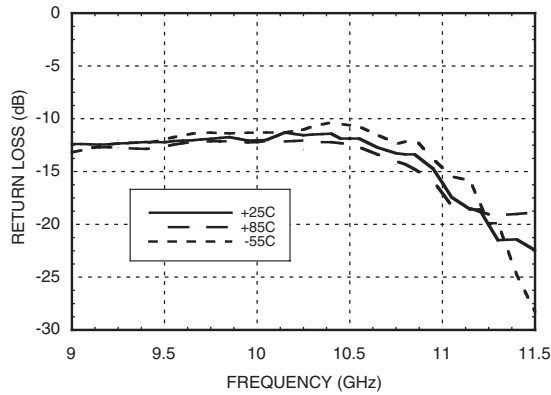

Output Return Loss vs. Temperature

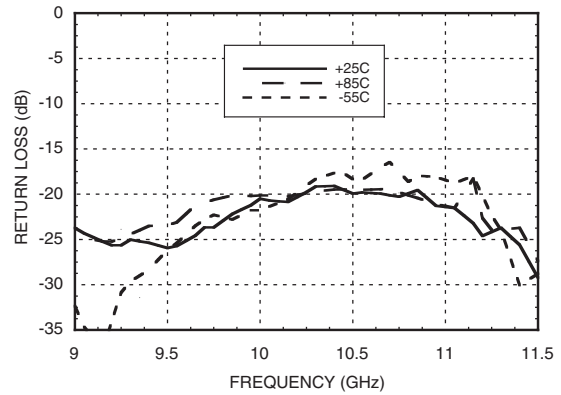

P1dB vs. Temperature

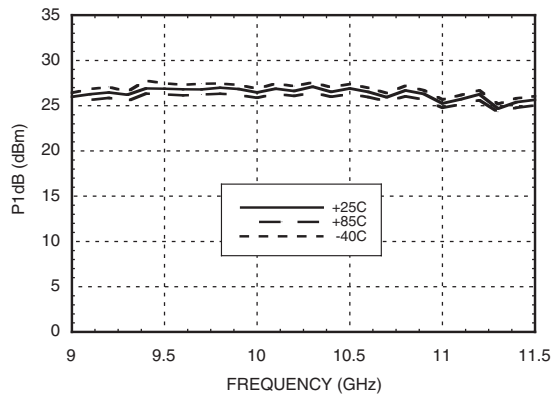

Psat vs. Temperature

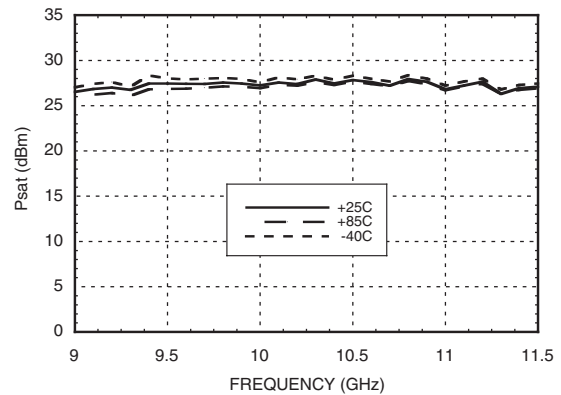

**GaAs PHEMT MEDIUM
POWER AMPLIFIER, 9.5 - 11.5 GHz**

Output IP3 vs. Temperature

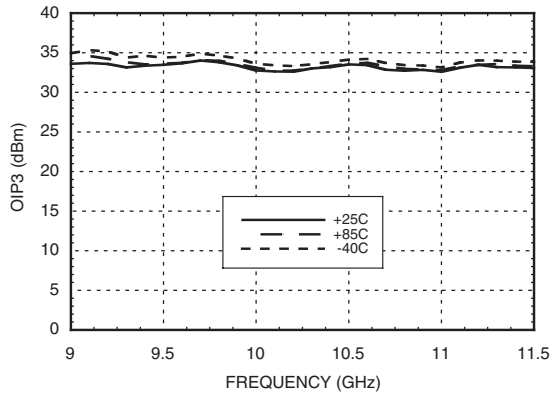

Noise Figure vs. Temperature

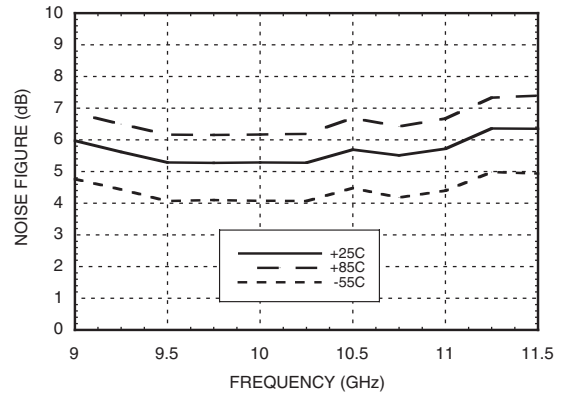

**Gain, Power & OIP3
vs. Supply Voltage @ 10.3 GHz**

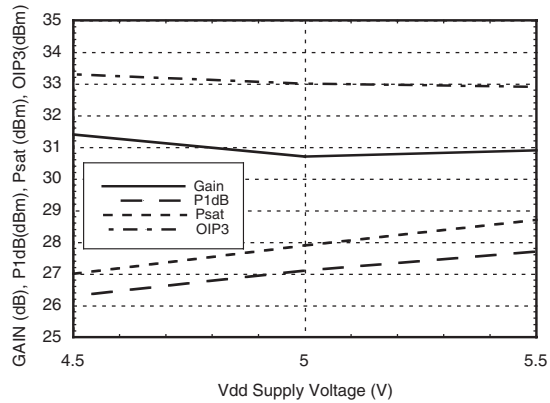

Reverse Isolation vs. Temperature

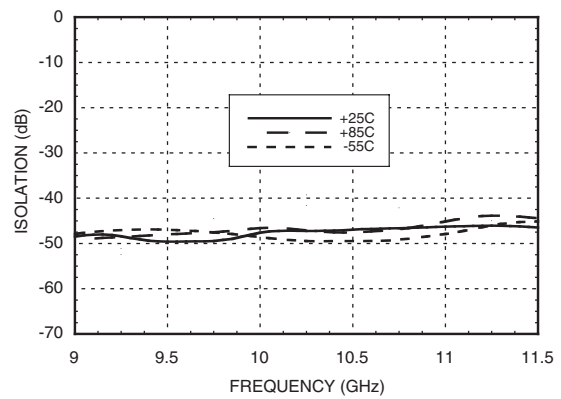

Power Compression @ 10.3 GHz

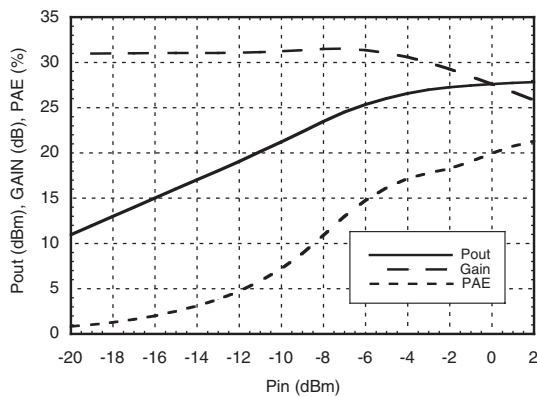

Power Dissipation

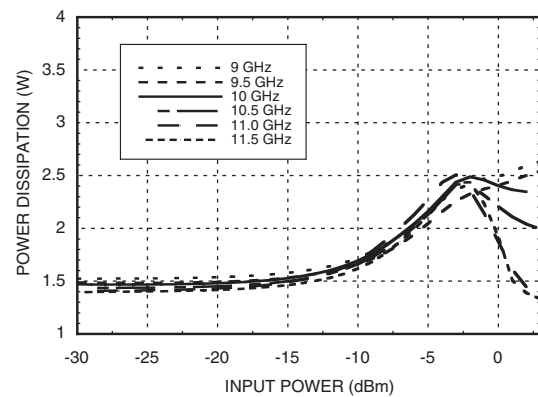

**GaAs PHEMT MEDIUM
POWER AMPLIFIER, 9.5 - 11.5 GHz**

**Low Gain Mode,
Broadband Gain & Return Loss**

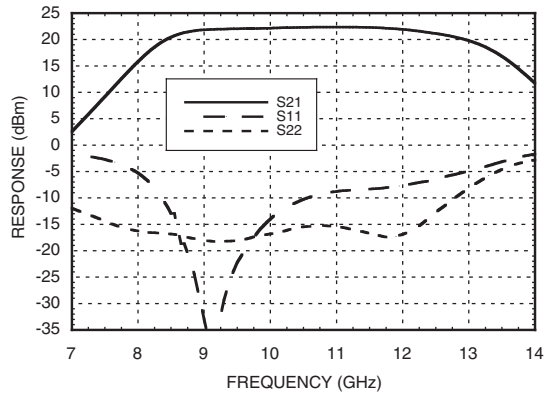

Low Gain Mode, Gain vs. Temperature

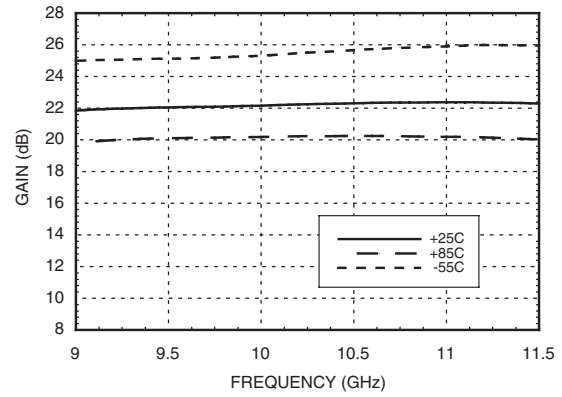

**Low Gain Mode,
Input Return Loss vs. Temperature**

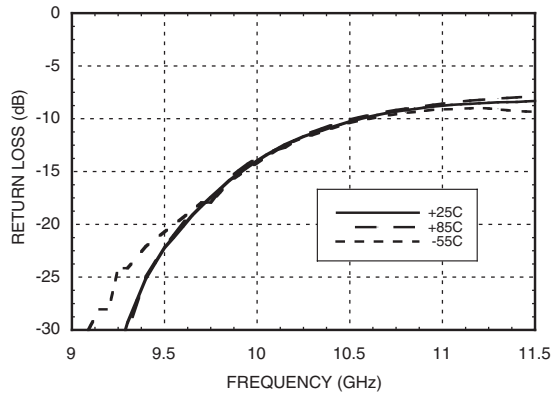

**Low Gain Mode,
Output Return Loss vs. Temperature**

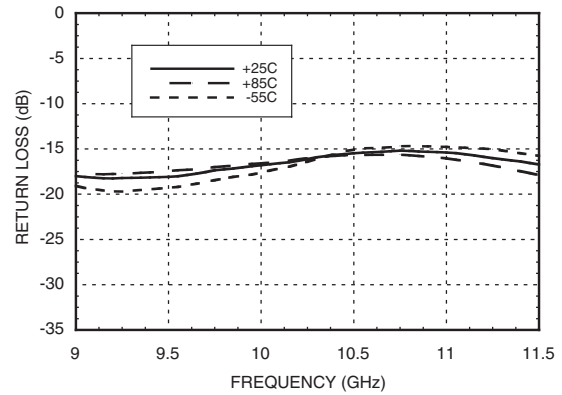

GaAs PHEMT MEDIUM POWER AMPLIFIER, 9.5 - 11.5 GHz

Absolute Maximum Ratings

Drain Bias Voltage (Vdd1, Vdd2, Vdd3)	7 Vdc
Gate Bias Voltage (Vgg)	-4.0 to -1.0 Vdc
RF Input Power (RFIn)(Vdd = +5.0 Vdc)	+10 dBm
Channel Temperature	175 °C
Continuous P _{diss} (T= 85 °C) (derate 25.89 mW/°C above 85 °C)	2.33W
Thermal Resistance (channel to die bottom)	38.6 °C/W
Storage Temperature	-65 to +150 °C
Operating Temperature	-55 to +85 °C

Typical Supply Current vs. Vdd

Vdd (Vdc)	I _{dd} (mA)
+4.5	300
+5.0	310
+5.5	325

Note: Amplifier will operate over full voltage ranges shown above. Vgg adjusted to achieve I_{dd}= 310 mA at +5.0V.



ELECTROSTATIC SENSITIVE DEVICE
OBSERVE HANDLING PRECAUTIONS

Outline Drawing

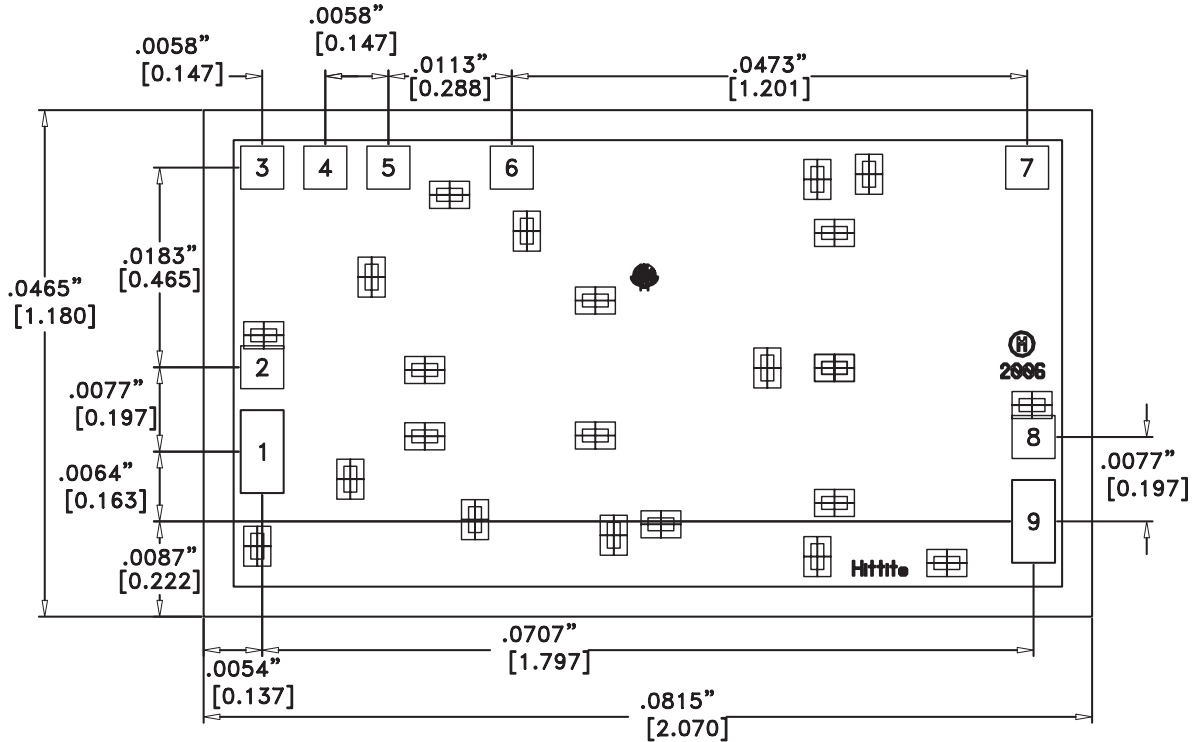

Die Packaging Information ^[1]

Standard	Alternate
GP-2	[2]

[1] Refer to the "Packaging Information" section for die packaging dimensions.



[2] For alternate packaging information contact Hittite Microwave Corporation.

NOTES:

- ALL DIMENSIONS IN INCHES [MILLIMETERS]
- NO CONNECTION REQUIRED FOR UNLABELED BOND PADS
- DIE THICKNESS IS 0.004 (0.100)
- TYPICAL BOND PAD IS 0.004 (0.100) SQUARE
- BACKSIDE METALLIZATION: GOLD
- BACKSIDE METAL IS GROUND
- BOND PAD METALIZATION: GOLD

**GaAs PHEMT MEDIUM
POWER AMPLIFIER, 9.5 - 11.5 GHz**

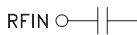
Pad Descriptions

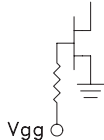
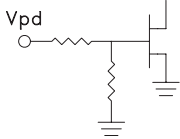
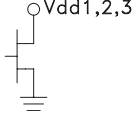
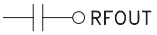
Pad Number	Function	Description	Interface Schematic
1	RFIN	This pad is AC coupled and matched to 50 Ohms.	
2, 8 and Die Bottom	GND	Die Bottom must be connected to RF/DC ground.	
3	Vgg	Gate control for amplifier. Adjust to achieve Id of 310mA. Please follow "MMIC Amplifier Biasing Procedure" Application Note. External bypass capacitors of 100 pF, 1000 pF and 2.2 μF are required.	
4	Vpd	High gain (connect to ground) / low gain mode pin control (open circuit). External bypass capacitors of 100 pF, 1000 pF and 2.2 μF are required.	
5, 6, 7	Vdd1, Vdd2, Vdd3	Power Supply Voltage for the amplifier. External bypass capacitors of 100 pF and 0.1 μF are required.	
9	RFOUT	This pad is AC coupled and matched to 50 Ohms.	

**GaAs PHEMT MEDIUM
POWER AMPLIFIER, 9.5 - 11.5 GHz**

Assembly Diagram

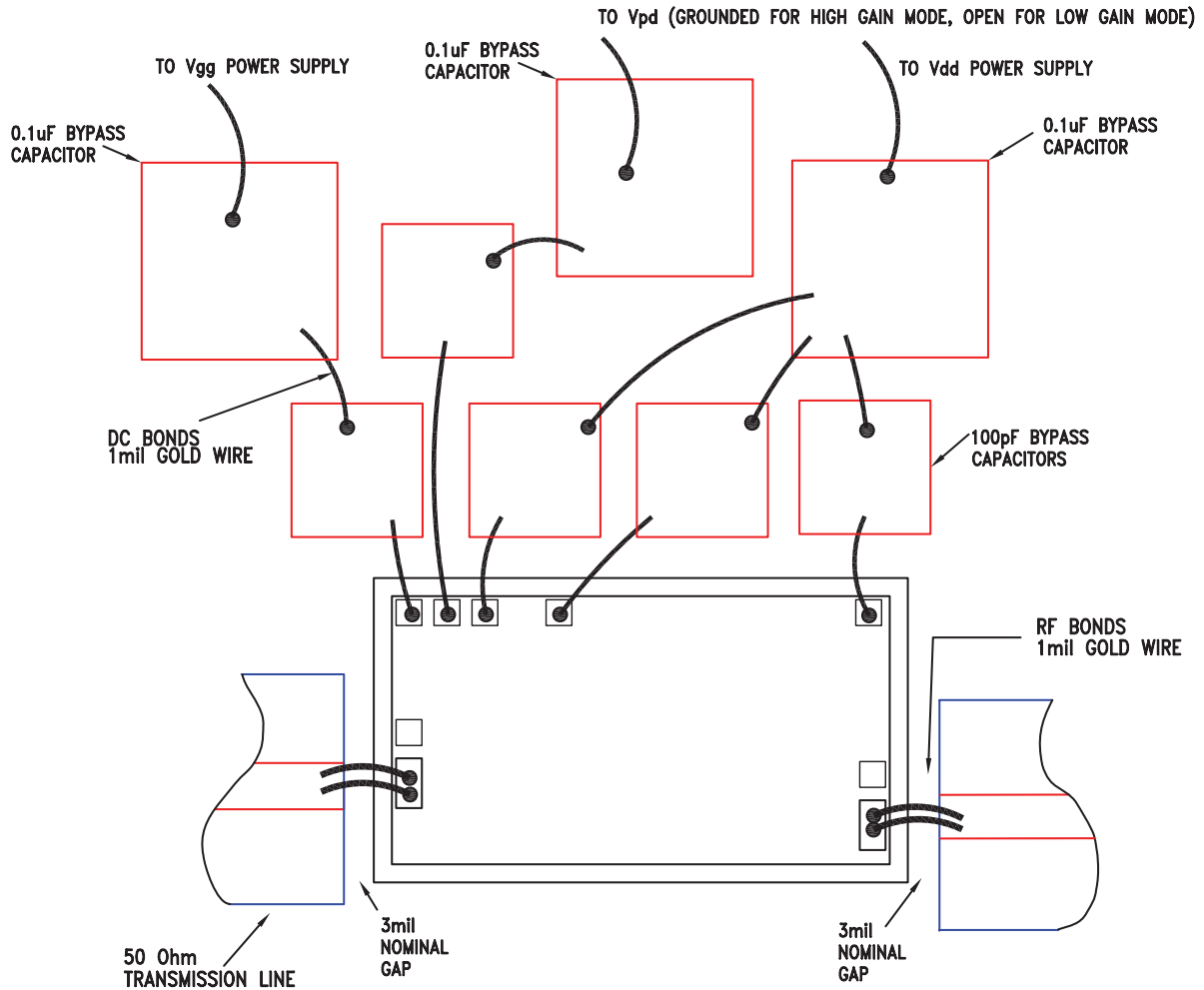

**GaAs PHEMT MEDIUM
POWER AMPLIFIER, 9.5 - 11.5 GHz**

Mounting & Bonding Techniques for Millimeterwave GaAs MMICs

The die should be attached directly to the ground plane eutectically or with conductive epoxy (see HMC general Handling, Mounting, Bonding Note).

50 Ohm Microstrip transmission lines on 0.127mm (5 mil) thick alumina thin film substrates are recommended for bringing RF to and from the chip (Figure 1). If 0.254mm (10 mil) thick alumina thin film substrates must be used, the die should be raised 0.150mm (6 mils) so that the surface of the die is coplanar with the surface of the substrate. One way to accomplish this is to attach the 0.102mm (4 mil) thick die to a 0.150mm (6 mil) thick molybdenum heat spreader (moly-tab) which is then attached to the ground plane (Figure 2).

Microstrip substrates should be brought as close to the die as possible in order to minimize bond wire length. Typical die-to-substrate spacing is 0.076mm (3 mils).

Handling Precautions

Follow these precautions to avoid permanent damage.

Storage: All bare die are placed in either Waffle or Gel based ESD protective containers, and then sealed in an ESD protective bag for shipment. Once the sealed ESD protective bag has been opened, all die should be stored in a dry nitrogen environment.

Cleanliness: Handle the chips in a clean environment. DO NOT attempt to clean the chip using liquid cleaning systems.

Static Sensitivity: Follow ESD precautions to protect against $\pm 250V$ ESD strikes.

Transients: Suppress instrument and bias supply transients while bias is applied. Use shielded signal and bias cables to minimize inductive pick-up.

General Handling: Handle the chip along the edges with a vacuum collet or with a sharp pair of bent tweezers. The surface of the chip has fragile air bridges and should not be touched with vacuum collet, tweezers, or fingers.

Mounting

The chip is back-metallized and can be die mounted with AuSn eutectic preforms or with electrically conductive epoxy. The mounting surface should be clean and flat.

Eutectic Die Attach: A 80/20 gold tin preform is recommended with a work surface temperature of 255 °C and a tool temperature of 265 °C. When hot 90/10 nitrogen/hydrogen gas is applied, tool tip temperature should be 290 °C. DO NOT expose the chip to a temperature greater than 320 °C for more than 20 seconds. No more than 3 seconds of scrubbing should be required for attachment.

Epoxy Die Attach: Apply a minimum amount of epoxy to the mounting surface so that a thin epoxy fillet is observed around the perimeter of the chip once it is placed into position. Cure epoxy per the manufacturer's schedule.

Wire Bonding

Ball or wedge bond with 0.025 mm (1 mil) diameter pure gold wire is recommended. Thermosonic wirebonding with a nominal stage temperature of 150 °C and a ball bonding force of 40 to 50 grams or wedge bonding force of 18 to 22 grams is recommended. Use the minimum level of ultrasonic energy to achieve reliable wirebonds. Wirebonds should be started on the chip and terminated on the package or substrate. All bonds should be as short as possible <0.31 mm (12 mils).

