

Agilent HPMX-7102 Dual-Band, Tri-Mode Downconverter Data Sheet

General Description

The HPMX-7102 downconverter offers a highly integrated solution for the CDMA Dual-Band, Tri-Mode (DBTM) handsets. This integrated solution leads to improvement in cost and reliability. The HPMX-7102 is part of the Agilent Technologies complete CDMA Advantage RF chipset.

The downconverter has a high input IP3 which is highly desirable for CDMA receiver dynamic range, noise, and spurious suppression.

The chip is comprised of three amplifier and mixer combinations. Individual mixers can be selected through band and mode control input.

The mixer outputs are differential providing common mode rejection. The outputs are high impedance open collectors. The HPMX-7102 features a current control of all three mixers through a DC voltage input Vcs. By setting the current varying linearity requirements can be accommodated. If used, dynamic current control reduces overall current consumption maximizing battery life.

The IC is housed in miniature BCC-24 package and manufactured on a high frequency, low noise Si-Bipolar process (25 GHz F_T). The entire IC can be put into a standby mode reducing current consumption to under 150 μ A.

Plastic BCC-24



Functional Block Diagram

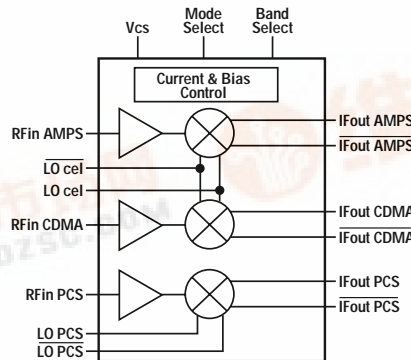

Features

- Wide band operation
- RF inputs:
 - Cellular AMPS/CDMA: 869 - 894 MHz
 - PCS CDMA: 1930 - 1990 MHz
- IF outputs:
 - Cellular AMPS: 85.38 MHz
 - Cellular CDMA: 85.38 MHz
 - PCS CDMA: 210.38 MHz
- 2.7 - 3.6 V operation
- Differential IF outputs
- High input IP3 and conversion gain
- Adjustable current
 - Cellular AMPS: 4 - 11 mA
 - Cellular CDMA: 7 - 18 mA
 - PCS CDMA: 6 - 17 mA
- JEDEC standard BCC-24 surface mount package

Applications

- Cellular handsets
- Wireless data terminals



HPMX-7102 Absolute Maximum Ratings^[1]

Parameter	Units	Min.	Max.
V _{cc} Supply Voltage	V		5
V _{cs} Control Voltage	V		V _{cc} + 0.5
V _{mode} , V _{band}	V		V _{cc}
Mixer Input, RF Power	dBm		5
Mixer Input, LO Power	dBm		7
Case Temperature	°C		125
Storage Temperature	°C	-55	125

Recommended operating range of V_{cc} = 2.7 to 3.6V, T_a = -40 to +85°C.

Note:

1. Operation of this device in excess of any of these limits may cause permanent damage.

HPMX-7102 Standard Test Conditions

Unless otherwise stated, all test data was taken on packaged parts under the following conditions:
V_{cc} = +3.0VDC, T_{ambient} = 25°C, I_{cc} at V_{cs} = 3V for CDMA 1900 and AMPS and V_{cs} = 2.5V for CDMA 800
Z_{RF} & LO source = 50Ω, Z_{IF load} = 500Ω. See Figure 46 for reference.

PCS CDMA:

LO input: 1749.62 MHz, -3 dBm, single-ended
RF input: 1960 MHz, -33 dBm, single-ended
IF output: 210.38 MHz

Cellular CDMA:

LO input: 966.88 MHz, -6 dBm, single-ended
RF input: 881 MHz, -33 dBm, single-ended
IF output: 85.38 MHz

Cellular AMPS:

LO input: 966.88 MHz, -6 dBm, single-ended
RF input: 881 MHz, -33 dBm, single-ended
IF output: 85.38 MHz

HPMX-7102 Summary Characterization Information

Standard test conditions apply unless otherwise noted.

Symbol	Parameters and Test Conditions	Min.	Typ.	Max.	Units
PCS CDMA					
Gc	Conversion Gain Vcs = 3 V Vcs = 1.5 V	11	12 11		dB
NF	Noise Figure Vcs = 3 V Vcs = 1.5 V		10 8	11.5	dB
IIP3	Input Third Order Intercept Vcs = 3 V Vcs = 1.5 V	2	5 0		dBm
OIP3	Output Third Order Intercept Vcs = 3 V Vcs = 1.5 V		17 11		dBm
RL	RF port Return Loss*		-13		dB
RL	IF port Return Loss*		-15		dB
RL	LO port Return Loss*		-11		dB
Icc	Current Vcs = 3V Vcs = 1.5V		18 9	22	mA mA
Cellular CDMA					
Gc	Conversion Gain Vcs = 2.5 V Vcs = 1.5 V	16	17 16		dB dB
NF	Noise Figure Vcs = 2.5 V Vcs = 1.5 V		9 6	10	dB dB
IIP3	Input Third Order Intercept Vcs = 2.5 V Vcs = 1.5 V	2	6 1		dBm dBm
OIP3	Output Third Order Intercept Vcs = 2.5 V Vcs = 1.5 V		23 18		dBm dBm
RL	RF port Return Loss*		-14		dB
RL	IF port Return Loss*		-10		dB
RL	LO port Return Loss*		-11		dB
Icc	Current Vcs = 3V Vcs = 1.5V		16 10	20	mA mA
Cellular AMPS					
Gc	Conversion Gain Vcs = 3 V Vcs = 1.5 V	15	16 15		dB dB
NF	Noise Figure Vcs = 3 V Vcs = 1.5 V		7 6	8.5	dB dB
IIP3	Input Third Order Intercept Vcs = 3 V Vcs = 1.5 V	0	2 -4		dBm dBm
OIP3	Output Third Order Intercept Vcs = 3 V Vcs = 1.5 V		18 11		dBm dBm
RL	RF port Return Loss*		-11		dB
RL	IF port Return Loss*		-11		dB
RL	LO port Return Loss*		-11		dB
Icc	Current Vcs = 3V Vcs = 1.5V		10 6	13	mA mA

* Externally matched

* For both LO and RF port return loss measurements, calibration removes all filters and attenuator pads shown in Figure 46.

* For IF port return loss measurements, the transformer is included in reported performance.

HPMX-7102 Pin Description Table

No.	Mnemonic	Description	Typical Signal	Notes
1	PCSIOutP	PCS differential IF output	IF	
2	PCSIOutM	PCS differential IF output	IF	
3	CellIFoutP	CDMA differential IF output	IF	
4	CellIFoutM	CDMA differential IF output	IF	
5	FMIFoutP	AMPS differential IF output	IF	
6	FMIFoutM	AMPS differential IF output	IF	
7	Gnd	Ground		
8	Band	Band selection signal (PCS or cellular band)	DC	
9	Mode	Mode selection signal (CDMA or AMPS mode)	DC	
10	Gnd	Ground		
11	Gnd	Ground		
12	Gnd	Ground		
13	Vcs	Current bias control signal	DC	
14	FMRFIn	RF AMPS input	RF	
15	CellRFIn	RF CDMA input	RF	
16	LGnd_Cel	Inductive Degeneration/Ground for Cellular Mixers		
17	LGnd_PCS	Inductive Degeneration/Ground for PCS Mixer		
18	LGnd_PCS	Inductive Degeneration/Ground for PCS Mixer		
19	PCSRFIn	RF PCS input	RF	
20	Vcc	Device Vcc input	DC	
21	PCSLOM	PCS LO differential input	RF	
22	PCSLOP	PCS LO differential input	RF	
23	CellLOP	Cellular LO differential input	RF	
24	CellLOM	Cellular LO differential input	RF	

HPMX-7102 Mode Control

Mode	Mode	Band
Power Down	0	0*
Cellular AMPS	0	1*
PCS CDMA	1	0
Cellular CDMA	1	1

* 1 = high, 0 = low

HPMX-7102 DC Logic

Parameter	Min	Max	Units
Input Logic, Low Voltage		0.5	V
Input Logic, High Voltage	2.5		V

HPMX-7102 Characterization Graphs for PCS CDMA

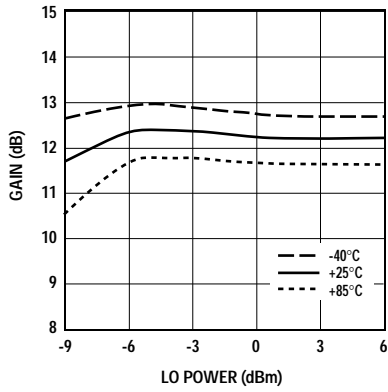

Figure 1. Gain vs. LO Power.

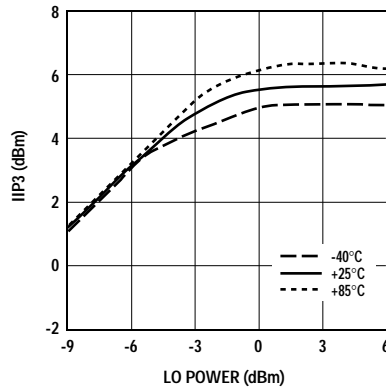

Figure 2. IIP3 vs. LO Power.

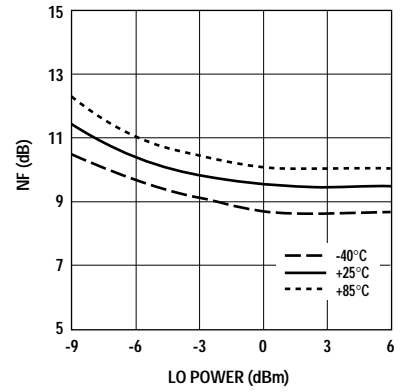

Figure 3. NF vs. LO Power.

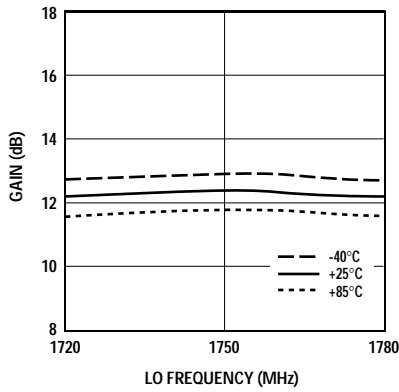

Figure 4. Gain vs. LO Frequency.

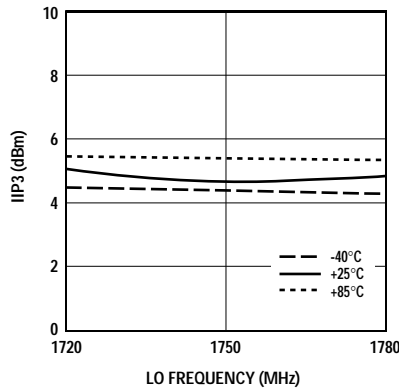

Figure 5. IIP3 vs. LO Frequency.

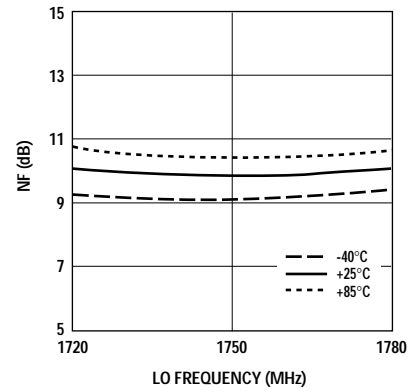

Figure 6. NF vs. LO Frequency.

Table 1. PCS CDMA, Gain vs. LO Power and Vcs.

LO Power (dBm)	Vcs (V)				
	1.4	1.8	2.2	2.6	3.0
-9	10.9	11.4	11.7	11.7	11.6
-6	11.0	11.5	11.9	12.2	12.4
-3	10.9	11.4	11.9	12.1	12.4
0	10.7	11.3	11.7	12.0	12.3
3	10.7	11.7	11.7	12.0	12.2
6	10.7	11.3	11.7	12.0	12.2

Table 2. PCS CDMA, IIP3 vs. LO Power and Vcs.

LO Power (dBm)	Vcs (V)				
	1.4	1.8	2.2	2.6	3.0
-9	-1.9	-0.8	0	0.4	1.0
-6	-1.4	0.3	1.5	2.4	3.1
-3	-1.5	0.7	2.3	3.6	4.7
0	-2.5	0.3	2.7	4.1	5.4
3	-3.0	0.3	2.6	4.3	5.7
6	-2.9	0.2	2.6	4.4	5.7

HPMX-7102 Characterization Graphs for PCS CDMA, continued

Table 3. PCS CDMA, NF vs. LO Power and Vcs.

LO Power (dBm)	Vcs (V)				
	1.4	1.8	2.2	2.6	3.0
-9	8.8	9.4	10.1	10.7	11.4
-6	8.4	8.9	9.4	9.9	10.4
-3	8.1	8.5	9.1	9.4	9.8
0	7.9	8.3	8.7	9.1	9.5
3	7.9	8.3	8.6	9.0	9.4
6	7.9	8.3	8.6	9.0	9.4

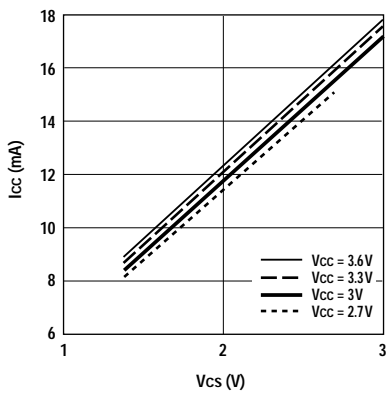

Figure 7A. Icc vs. Vcs.

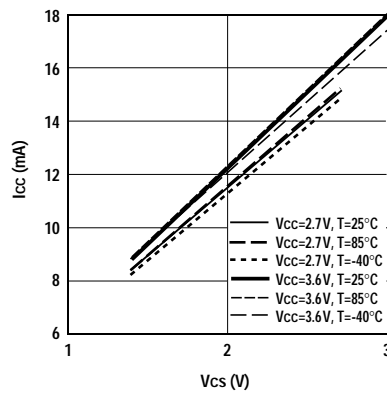

Figure 7B. Icc vs. Vcs.

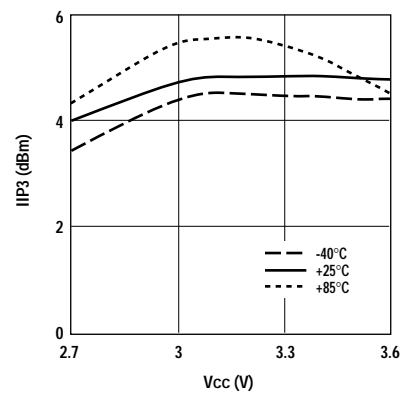

Figure 8. IIP3 vs. Vcc.

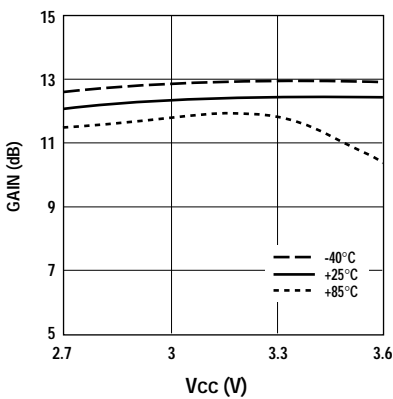

Figure 9. Gain vs. Vcc.

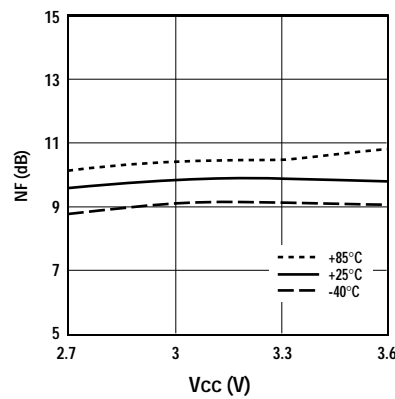

Figure 10. NF vs. Vcc.

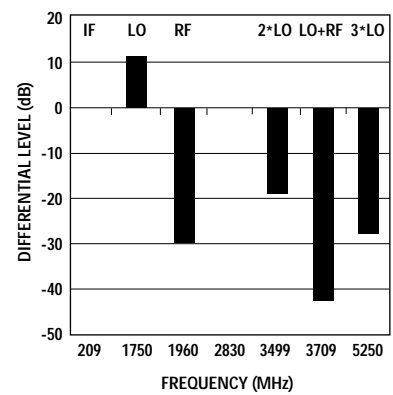

Figure 11. Differential Spur Level at IF pins.^[1]

Note:

1. Measurement performed at IF pins (matching circuit and balun removed).

HPMX-7102 Characterization Graphs for PCS CDMA, continued

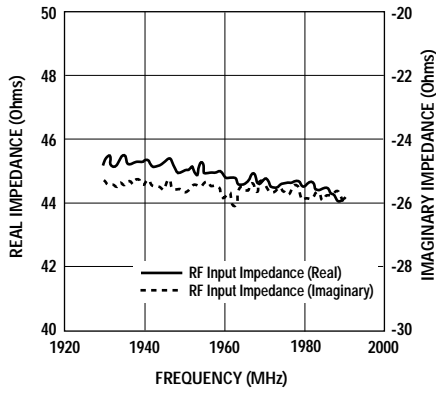

Figure 12. RF Input Impedance vs. Frequency.^[1]

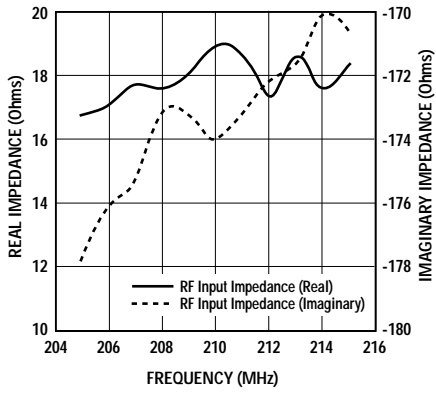

Figure 13. IF Input Impedance (differential) vs. Frequency.^[1]

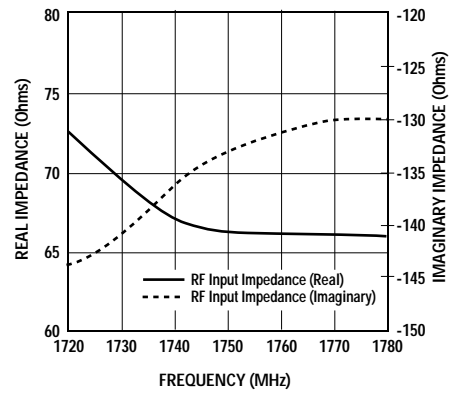

Figure 14. LO Input Impedance (differential) vs. Frequency.^[1]

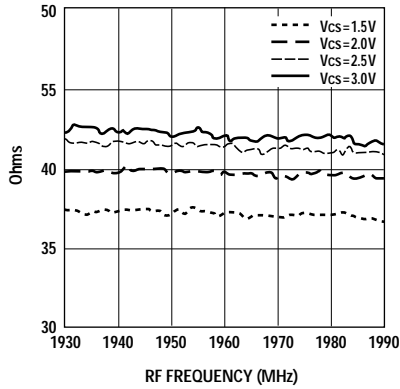

Figure 15A. PCS-CDMA RF Impedance (Real).^[1]

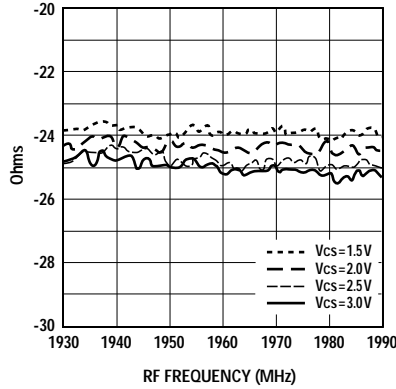

Figure 15B. PCS-CDMA RF Impedance (Reactive).^[1]

Note:

1. Impedance data measured with all other ports matched as shown in Figure 46.

HPMX-7102 Characterization Graphs for 800 MHz CDMA

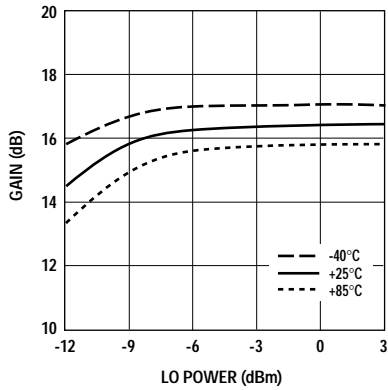

Figure 16. Gain vs. LO Power.

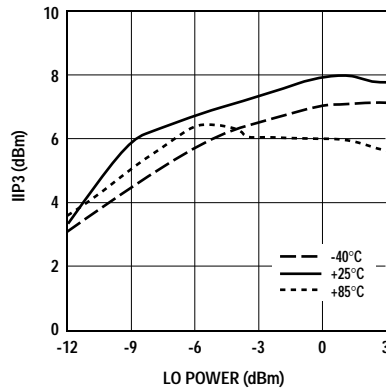

Figure 17. IIP3 vs. LO Power.

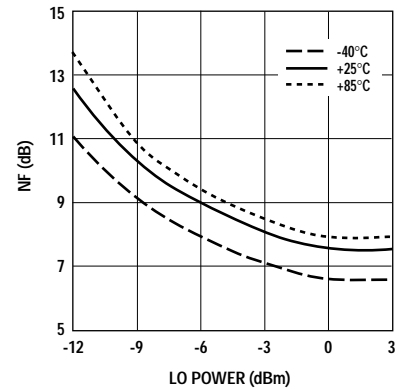

Figure 18. NF vs. LO Power.

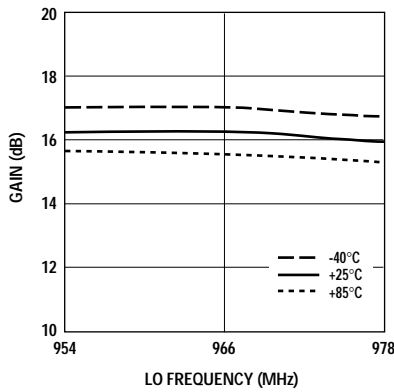

Figure 19. Gain vs. LO Frequency.

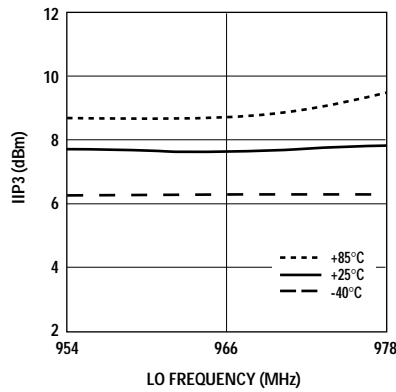

Figure 20. IIP3 vs. LO Frequency.

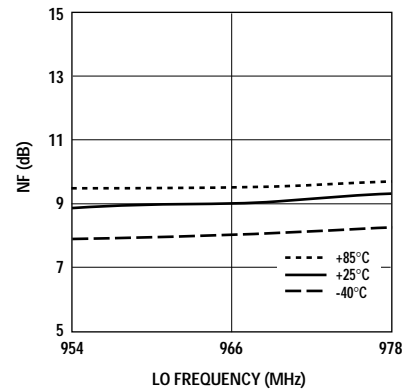

Figure 21. NF vs. LO Frequency.

Table 4. Cell CDMA, Gain vs. LO Power and Vcs.

LO Power (dBm)	Vcs (V)					
	1.4	1.8	2.2	2.5	2.6	3.0
-12	14.9	14.9	14.7	14.5	14.4	13.9
-9	15.5	15.7	15.8	15.8	15.8	15.8
-6	15.8	16.0	16.2	16.3	16.3	16.3
-3	15.8	16.1	16.3	16.4	16.4	16.5
0	15.9	16.1	16.3	16.4	16.5	16.6
3	15.9	16.1	16.3	16.4	16.5	16.5

Table 5. Cell CDMA, IIP3 vs. LO Power and Vcs.

LO Power (dBm)	Vcs (V)					
	1.4	1.8	2.2	2.5	2.6	3.0
-12	-0.6	1.5	2.5	2.9	3.0	3.2
-9	0	2.8	4.6	5.6	6.1	7.5
-6	0.1	3.5	5.9	7.6	8.5	9.6
-3	0.1	3.8	6.7	8.7	9.6	9.2
0	0.1	3.9	7.1	9.1	9.9	9.2
3	0.1	3.9	7.1	9.2	10.1	8.8

HPMX-7102 Characterization Graphs for 800 MHz CDMA, continued

Table 6. Cell CDMA, NF vs. LO Power and Vcs.

LO Power (dBm)	Vcs (V)					
	1.4	1.8	2.2	2.5	2.6	3.0
-12	9.2	10.4	11.7	12.7	13.0	14.3
-9	7.9	8.9	9.7	10.3	10.6	11.4
-6	7.1	7.8	8.5	9.0	9.3	9.8
-3	6.6	7.2	7.8	8.2	8.3	8.8
0	6.2	6.8	7.2	7.6	7.7	8.2
3	6.2	6.8	7.3	7.6	7.7	8.2

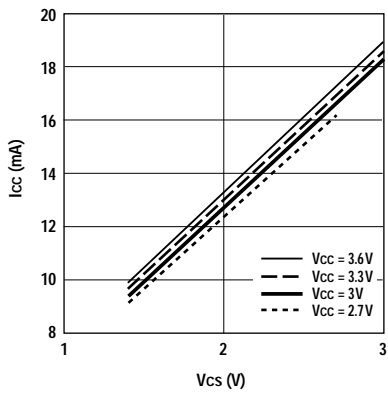

Figure 22A. Icc vs. Vcs.

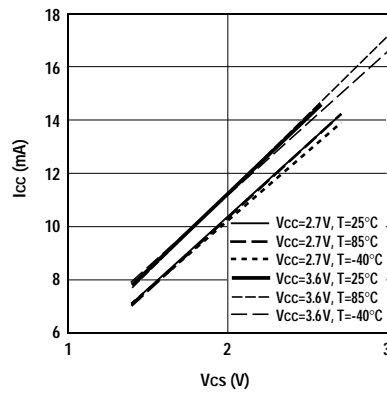

Figure 22B. Icc vs. Vcs.

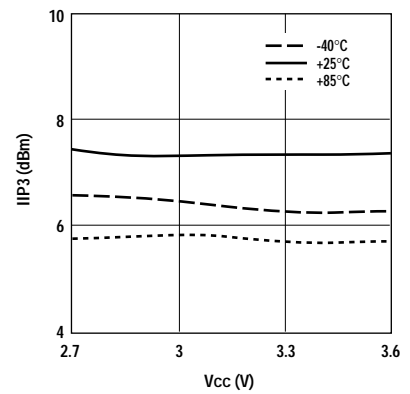

Figure 23. IIP3 vs. Vcc.

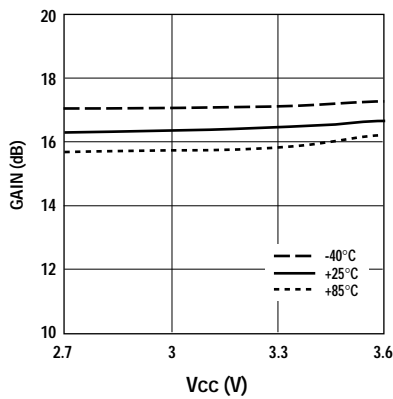

Figure 24. Gain vs. Vcc.

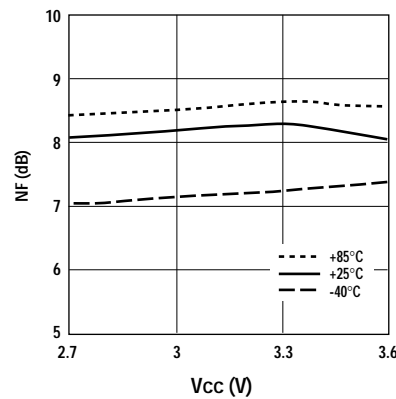

Figure 25. Noise Figure vs. Vcc.

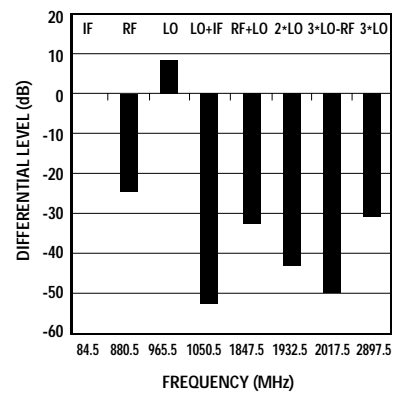

Figure 26. Differential Spur Level at IF pins.^[1]

Note:

1. Measurement performed at IF pins (matching circuit and balun removed).

HPMX-7102 Characterization Graphs for 800 MHz CDMA, continued

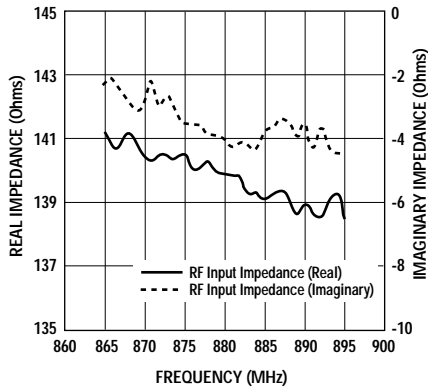

Figure 27. RF Input Impedance vs. Frequency.^[1]

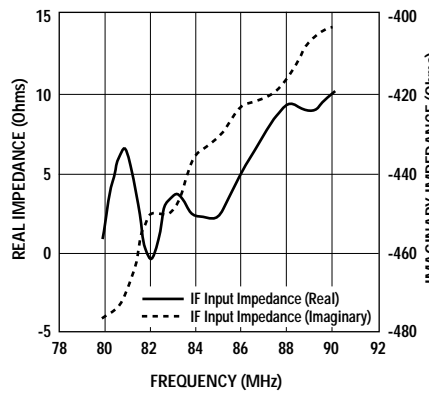

Figure 28. IF Input Impedance (differential) vs. Frequency.^[1]

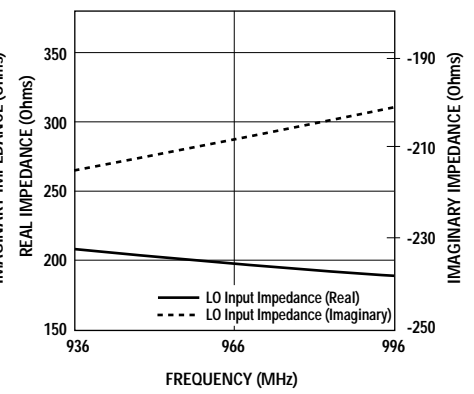

Figure 29. LO Input Impedance (differential) vs. Frequency.^[1]

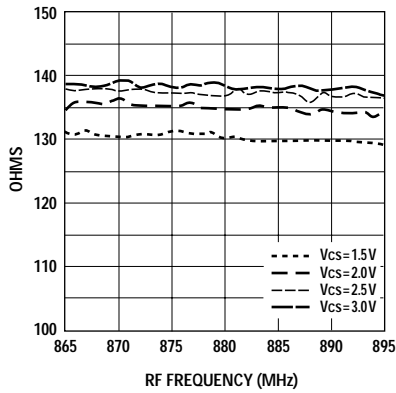

Figure 30A. Cellular CDMA RF Impedance (Real).^[1]

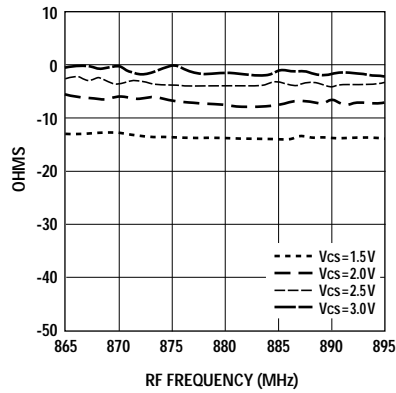

Figure 30B. Cellular CDMA RF Impedance (Reactive).^[1]

Note:

1. Impedance data measured with all other ports matched as shown in Figure 46.

HPMX-7102 Characterization Graphs for AMPS

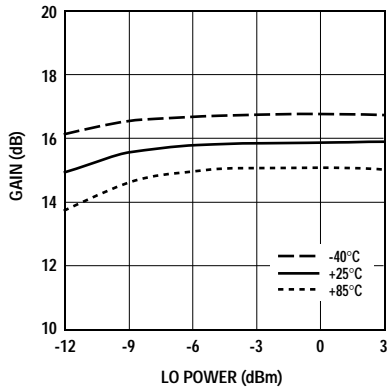

Figure 31. Gain vs. LO Power.

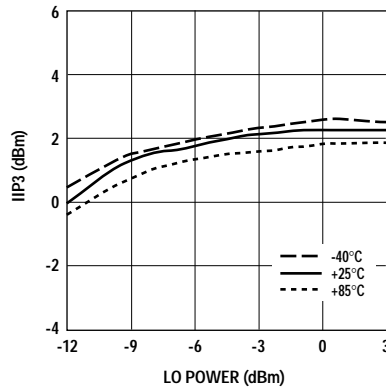

Figure 32. IIP3 vs. LO Power.

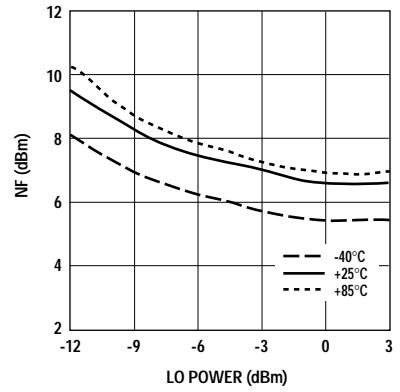

Figure 33. NF vs. LO Power.

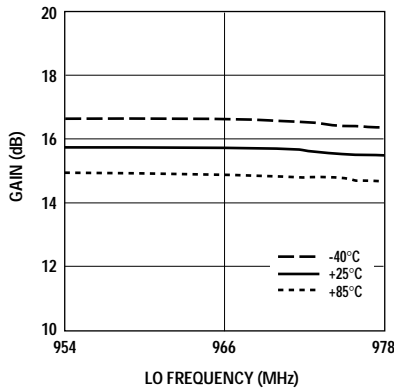

Figure 34. Gain vs. LO Frequency.

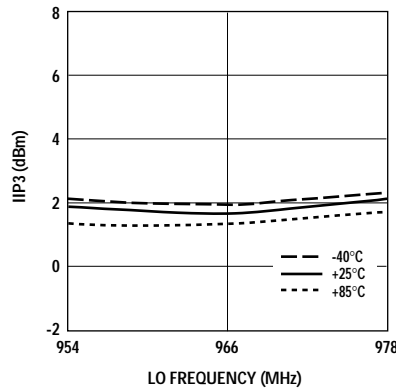

Figure 35. IIP3 vs. LO Frequency.

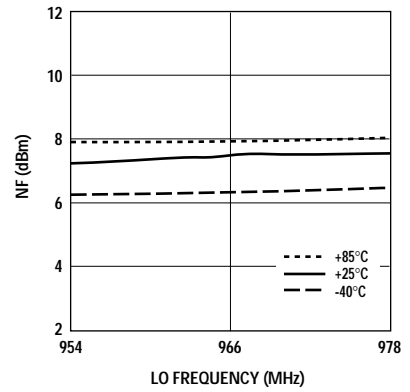

Figure 36. NF vs. LO Frequency.

Table 7. Cell AMPS, Gain vs. LO Power and Vcs.

LO Power (dBm)	Vcs (V)					
	1.4	1.8	2.2	2.5	2.6	3.0
-12	14.1	14.5	14.8	14.8	14.9	14.9
-9	14.5	15.0	15.3	15.4	15.4	15.5
-6	14.7	15.2	15.5	15.6	15.6	15.8
-3	14.8	15.2	15.5	15.7	15.7	15.9
0	14.8	15.3	15.6	15.7	15.8	15.9
3	14.8	15.3	15.6	15.7	15.8	16.0

Table 8. Cell AMPS, IIP3 vs. LO Power and Vcs.

LO Power (dBm)	Vcs (V)					
	1.4	1.8	2.2	2.5	2.6	3.0
-12	-6.7	-4.4	-2.6	-1.4	-1.0	0
-9	-6.4	-4.0	-2.0	-0.6	-0.1	1.3
-6	-6.1	-3.7	-1.7	-0.3	0.2	1.7
-3	-6.1	-3.6	-1.4	0	0.5	2.1
0	-6.6	-3.6	-1.3	0.2	0.7	2.2
3	-6.6	-3.6	-1.4	0.2	0.6	2.3

HPMX-7102 Characterization Graphs for AMPS, continued

Table 9. Cell AMPS, NF vs. LO Power vs. Vcs.

LO Power (dBm)	Vcs (V)					
	1.4	1.8	2.2	2.5	2.6	3.0
-12	7.1	7.7	8.3	8.8	9.0	9.6
-9	6.4	6.9	7.3	7.7	7.9	8.3
-6	6.0	6.3	6.7	7.0	7.1	7.5
-3	5.8	6.1	6.3	6.6	6.7	7.0
0	5.6	5.9	6.1	6.3	6.3	6.6
3	5.5	5.7	6.0	6.3	6.3	6.6

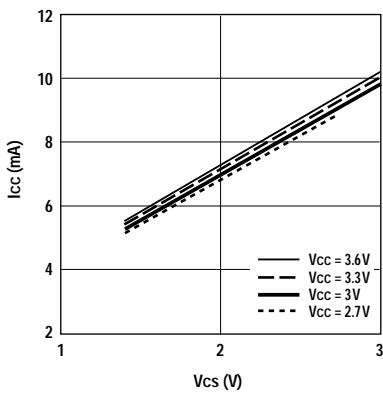

Figure 37A. Icc vs. Vcs.

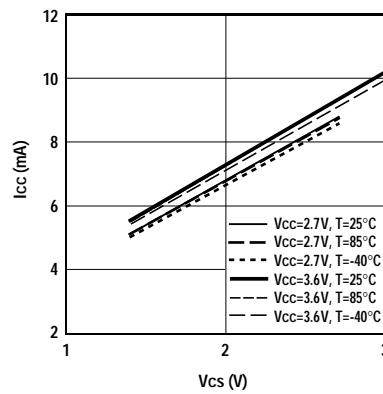

Figure 37B. Icc vs. Vcs.

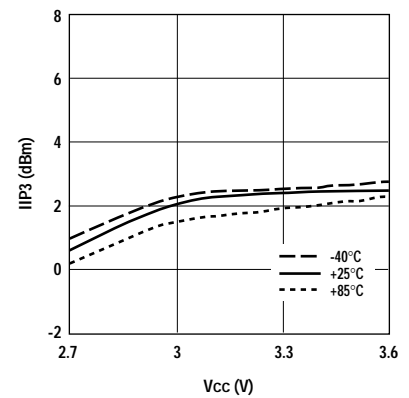

Figure 38. IIP3 vs. Vcc.

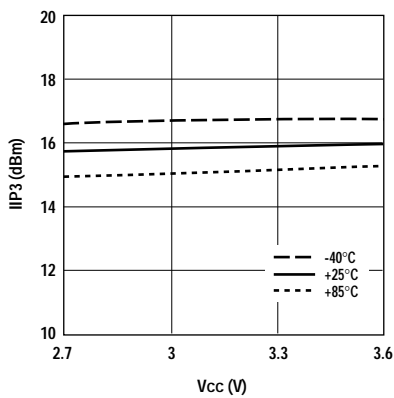

Figure 39. Gain vs. Vcc.

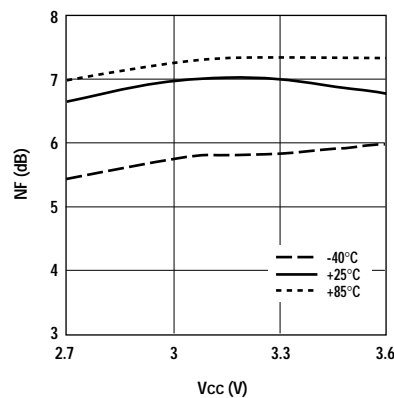

Figure 40. Noise Figure vs. Vcc.

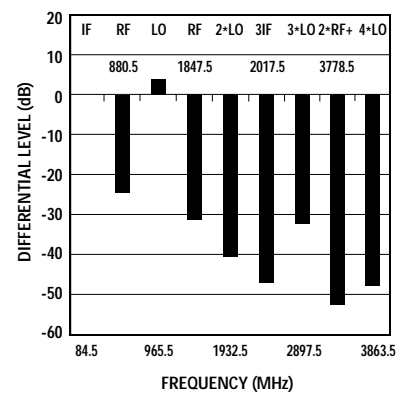

Figure 41. Differential Spur Level at IF pins^[1].

Note:

1. Measurement performed at IF pins (matching circuit and balun removed).

HPMX-7102 Characterization Graphs for AMPS, continued

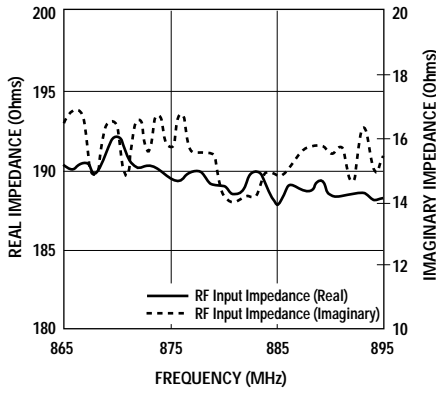

Figure 42. RF Input Impedance vs. Frequency.

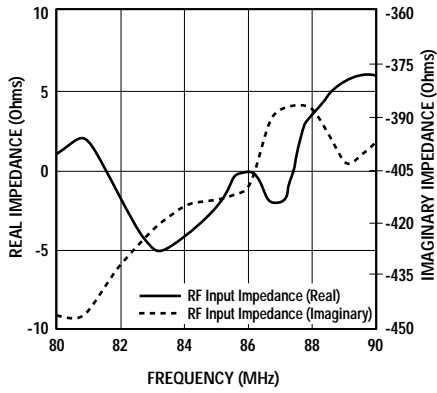

Figure 43. IF Input Impedance vs. Frequency.

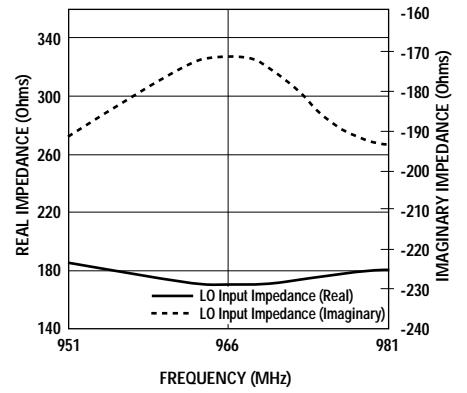

Figure 44. LO Input Impedance vs. Frequency.

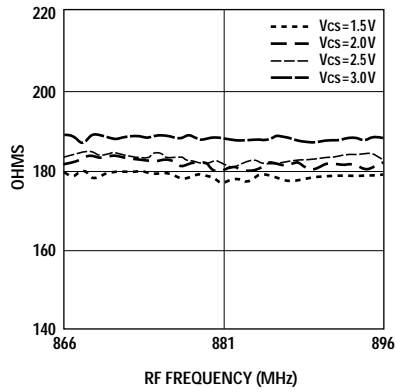

Figure 45A. Cell-AMPS RF Impedance (Real).

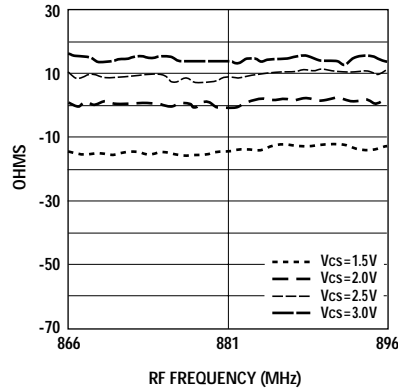

Figure 45B. Cell-AMPS RF Impedance (Reactive).

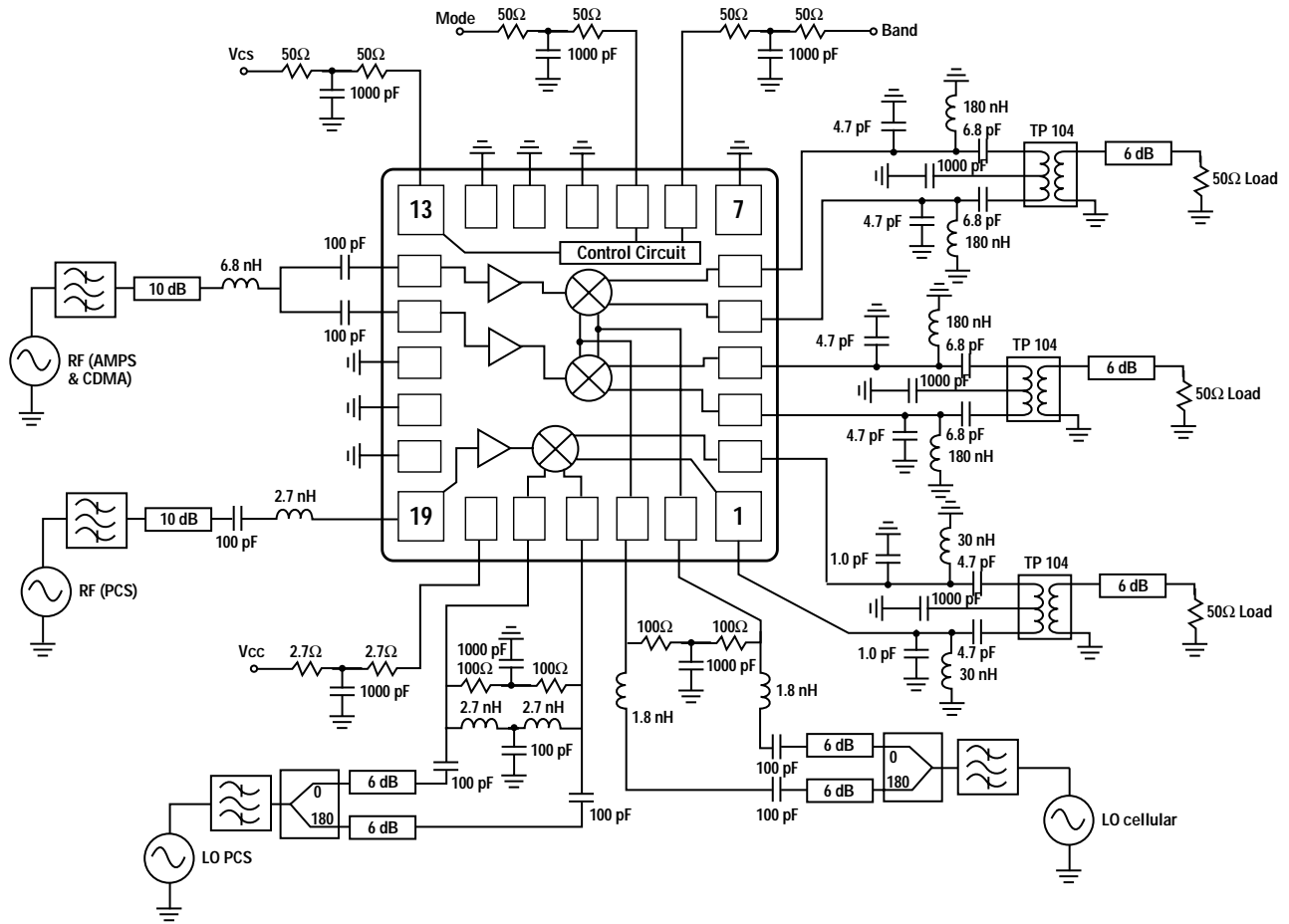

Figure 46. HPMX-7102 Test Diagram.

Note: This test diagram represents the testing configuration used to measure the data in the datasheet, and is not the demoboard diagram.

Part Number Ordering Information

Part Number	No. of Devices	Container
HPMX-7102-BLK	10	Bulk
HPMX-7102-TR1	1000	7" Tape and Reel

Package Dimensions JEDEC Standard BCC-24 Package

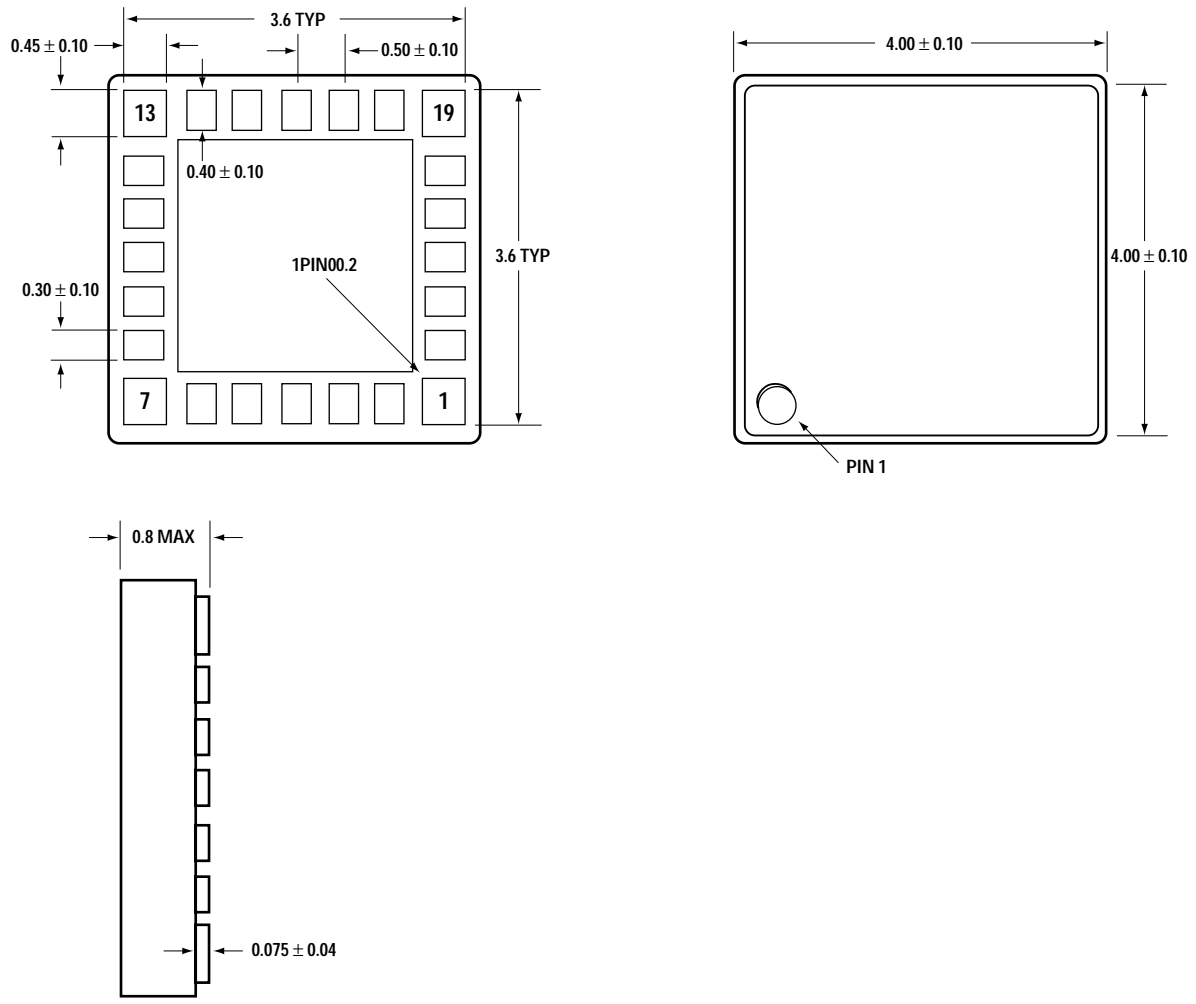

www.semiconductor.agilent.com

Data subject to change.

Copyright © 2000 Agilent Technologies, Inc.

5980-2432E (11/00)



Agilent Technologies

Innovating the HP Way