



Integrated
Circuit
Systems, Inc.

ICS83056I

6:1, SINGLE-ENDED MULTIPLEXER

GENERAL DESCRIPTION

The ICS83056I is a low skew, 6:1, Single-ended Multiplexer and a member of the HiPerClockS™ family of High Performance Clock Solutions from ICS. The ICS83056I has six selectable single-ended clock inputs and one single-ended clock output. The output has a V_{DDO} pin which may be set at 3.3V, 2.5V, or 1.8V, making the device ideal for use in voltage translation applications. An output enable pin places the output in a high impedance state which may be useful for testing or debug. The device operates up to 250MHz and is packaged in a 16 TSSOP.

FEATURES

- 6:1 single-ended multiplexer
- Q nominal output impedance: 7Ω ($V_{DDO} = 3.3V$)
- Maximum output frequency: 250MHz
- Propagation delay: 3ns (maximum), $V_{DD} = V_{DDO} = 3.3V$
- Input skew: 225ps (maximum), $V_{DD} = V_{DDO} = 3.3V$
- Part-to-part skew: 475ps (maximum), $V_{DD} = V_{DDO} = 3.3V$
- Operating supply modes:
 - V_{DD}/V_{DDO}
 - 3.3V/3.3V
 - 3.3V/2.5V
 - 3.3V/1.8V
 - 2.5V/2.5V
 - 2.5V/1.8V
- $-40^{\circ}C$ to $85^{\circ}C$ ambient operating temperature
- Available in both standard and lead-free RoHS-compliant packages

BLOCK DIAGRAM

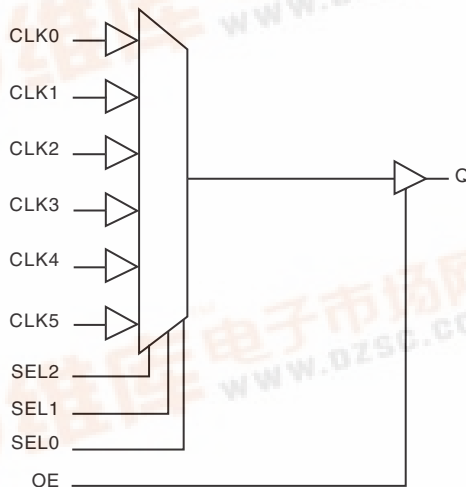

PIN ASSIGNMENT

Q	1	16	V_{DDO}
nc	2	15	CLK0
OE	3	14	SEL0
nc	4	13	CLK1
GND	5	12	V_{DD}
CLK5	6	11	CLK2
SEL2	7	10	SEL1
CLK4	8	9	CLK3

ICS83056I

16-Lead TSSOP

4.4mm x 5.0mm x 0.92mm package body

G Package

Top View



TABLE 1. PIN DESCRIPTIONS

Number	Name	Type		Description
1	Q	Output		Single-ended clock output. LVCMOS/LVTTL interface levels.
2, 4	nc	Unused		No connect.
6, 8, 9, 11, 13, 15	CLK5, CLK4, CLK3, CLK2, CLK1, CLK0	Input	Pulldown	Single-ended clock inputs. LVCMOS/LVTTL interface levels.
3	OE	Input	Pullup	Output enable. When LOW, outputs are in HIGH impedance state. When HIGH, outputs are active. LVCMOS / LVTTL interface levels.
5	GND	Power		Power supply ground.
7, 10, 14	SEL2, SEL1, SEL0	Input	Pulldown	Clock select input. See Control Input Function Table. LVCMOS / LVTTL interface levels.
12	V _{DD}	Power		Core and input supply pin.
16	V _{DDO}	Power		Output supply pin.

NOTE: *Pullup* and *Pulldown* refer to internal input resistors. See Table 2, Pin Characteristics, for typical values.

TABLE 2. PIN CHARACTERISTICS

Symbol	Parameter	Test Conditions	Minimum	Typical	Maximum	Units
C _{IN}	Input Capacitance			4		pF
R _{PULLUP}	Input Pullup Resistor			51		kΩ
R _{PULLDOWN}	Input Pulldown Resistor			51		kΩ
C _{PD}	Power Dissipation Capacitance (per output)	V _{DDO} = 3.465V		18		pF
		V _{DDO} = 2.625V		20		pF
		V _{DDO} = 1.89V		30		pF
R _{OUT}	Output Impedance	V _{DDO} = 3.465V		7		Ω
		V _{DDO} = 2.625V		7		Ω
		V _{DDO} = 1.89V		10		Ω

TABLE 3. CONTROL INPUT FUNCTION TABLE

Control Inputs			Input Selected to Q
SEL2	SEL1	SEL0	
0	0	0	CLK0
0	0	1	CLK1
0	1	0	CLK2
0	1	1	CLK3
1	0	0	CLK4
1	0	1	CLK5
1	1	0	LOW
1	1	1	LOW



ABSOLUTE MAXIMUM RATINGS

Supply Voltage, V_{DD}	4.6V
Inputs, V_i	-0.5V to $V_{DD} + 0.5V$
Outputs, V_o	-0.5V to $V_{DDO} + 0.5V$
Package Thermal Impedance, θ_{JA}	89°C/W (0 lfpm)
Storage Temperature, T_{STG}	-65°C to 150°C

NOTE: Stresses beyond those listed under Absolute Maximum Ratings may cause permanent damage to the device. These ratings are stress specifications only. Functional operation of product at these conditions or any conditions beyond those listed in the *DC Characteristics* or *AC Characteristics* is not implied. Exposure to absolute maximum rating conditions for extended periods may affect product reliability.

TABLE 4A. POWER SUPPLY DC CHARACTERISTICS, $V_{DD} = V_{DDO} = 3.3V \pm 5\%$, $T_A = -40^\circ C$ TO $85^\circ C$

Symbol	Parameter	Test Conditions	Minimum	Typical	Maximum	Units
V_{DD}	Core Supply Voltage		3.135	3.3	3.465	V
V_{DDO}	Output Supply Voltage		3.135	3.3	3.465	V
I_{DD}	Power Supply Current				40	mA
I_{DDO}	Output Supply Current				5	mA

TABLE 4B. POWER SUPPLY DC CHARACTERISTICS, $V_{DD} = 3.3V \pm 5\%$, $V_{DDO} = 2.5V \pm 5\%$, $T_A = -40^\circ C$ TO $85^\circ C$

Symbol	Parameter	Test Conditions	Minimum	Typical	Maximum	Units
V_{DD}	Core Supply Voltage		3.135	3.3	3.465	V
V_{DDO}	Output Supply Voltage		2.375	2.5	2.625	V
I_{DD}	Power Supply Current				40	mA
I_{DDO}	Output Supply Current				5	mA

TABLE 4C. POWER SUPPLY DC CHARACTERISTICS, $V_{DD} = 3.3V \pm 5\%$, $V_{DDO} = 1.8V \pm 0.2V$, $T_A = -40^\circ C$ TO $85^\circ C$

Symbol	Parameter	Test Conditions	Minimum	Typical	Maximum	Units
V_{DD}	Core Supply Voltage		3.135	3.3	3.465	V
V_{DDO}	Output Supply Voltage		1.71	1.8	1.89	V
I_{DD}	Power Supply Current				40	mA
I_{DDO}	Output Supply Current				5	mA

TABLE 4D. POWER SUPPLY DC CHARACTERISTICS, $V_{DD} = V_{DDO} = 2.5V \pm 5\%$, $T_A = -40^\circ C$ TO $85^\circ C$

Symbol	Parameter	Test Conditions	Minimum	Typical	Maximum	Units
V_{DD}	Core Supply Voltage		2.375	2.5	2.625	V
V_{DDO}	Output Supply Voltage		2.375	2.5	2.625	V
I_{DD}	Power Supply Current				35	mA
I_{DDO}	Output Supply Current				5	mA

TABLE 4E. POWER SUPPLY DC CHARACTERISTICS, $V_{DD} = 2.5V \pm 5\%$, $V_{DDO} = 1.8V \pm 0.2V$, $T_A = -40^\circ C$ TO $85^\circ C$

Symbol	Parameter	Test Conditions	Minimum	Typical	Maximum	Units
V_{DD}	Core Supply Voltage		2.375	2.5	2.625	V
V_{DDO}	Output Supply Voltage		1.71	1.8	1.89	V
I_{DD}	Power Supply Current				35	mA
I_{DDO}	Output Supply Current				5	mA



TABLE 4F. LVCMOS/LVTTL DC CHARACTERISTICS, $T_A = -40^{\circ}\text{C}$ TO 85°C

Symbol	Parameter	Test Conditions	Minimum	Typical	Maximum	Units
V_{IH}	Input High Voltage	$V_{DD} = 3.3\text{V} \pm 5\%$	2		$V_{DD} + 0.3$	V
		$V_{DD} = 2.5\text{V} \pm 5\%$	1.7		$V_{DD} + 0.3$	V
V_{IL}	Input Low Voltage	$V_{DD} = 3.3\text{V} \pm 5\%$	-0.3		0.8	V
		$V_{DD} = 2.5\text{V} \pm 5\%$	-0.3		0.7	V
I_{IH}	Input High Current	CLK0:CLK5, SEL0:SEL2	$V_{DD} = 3.3\text{V}$ or $2.5\text{V} \pm 5\%$		150	μA
		OE	$V_{DD} = 3.3\text{V}$ or $2.5\text{V} \pm 5\%$		5	μA
I_{IL}	Input Low Current	CLK0:CLK5, SEL0:SEL2	$V_{DD} = 3.3\text{V}$ or $2.5\text{V} \pm 5\%$	-5		μA
		OE	$V_{DD} = 3.3\text{V}$ or $2.5\text{V} \pm 5\%$	-150		μA
V_{OH}	Output High Voltage	$V_{DDO} = 3.3\text{V} \pm 5\%$; NOTE 1	2.6			V
		$V_{DDO} = 2.5\text{V} \pm 5\%$; NOTE 1	1.8			V
		$V_{DDO} = 1.8\text{V} \pm 5\%$; NOTE 1	$V_{DD} - 0.3$			V
V_{OL}	Output Low Voltage	$V_{DDO} = 3.3\text{V} \pm 5\%$; NOTE 1			0.5	V
		$V_{DDO} = 2.5\text{V} \pm 5\%$; NOTE 1			0.45	V
		$V_{DDO} = 1.8\text{V} \pm 5\%$; NOTE 1			0.35	V

NOTE 1: Outputs terminated with 50Ω to $V_{DDO}/2$. See Parameter Measurement section, "Load Test Circuit" diagrams.

TABLE 5A. AC CHARACTERISTICS, $V_{DD} = V_{DDO} = 3.3\text{V} \pm 5\%$, $T_A = -40^{\circ}\text{C}$ TO 85°C

Symbol	Parameter	Test Conditions	Minimum	Typical	Maximum	Units
f_{MAX}	Output Frequency				250	MHz
tp_{LH}	Propagation Delay, Low to High; NOTE 1		2.4	2.7	3.0	ns
tp_{HL}	Propagation Delay, High to Low; NOTE 1		2.5	2.7	2.9	ns
$t_{sk(i)}$	Input Skew; NOTE 2			55	225	ps
$t_{sk(pp)}$	Part-to-Part Skew; NOTE 2, 3				475	ps
t_R / t_F	Output Rise/Fall Time	20% to 80%	50		500	ps
odc	Output Duty Cycle		45		55	%
MUX_{ISOL}	MUX Isolation	@ 100MHz		45		dB

NOTE 1: Measured from $V_{DD}/2$ of the input to $V_{DDO}/2$ of the output.

NOTE 2: This parameter is defined in accordance with JEDEC Standard 65.

NOTE 3: Defined as skew between outputs on different devices operating at the same supply voltages and with equal load conditions. Using the same type of input on each device, the output is measured at $V_{DDO}/2$.



TABLE 5B. AC CHARACTERISTICS, $V_{DD} = 3.3V \pm 5\%$, $V_{DDO} = 2.5V \pm 5\%$, $T_A = -40^\circ\text{C}$ TO 85°C

Symbol	Parameter	Test Conditions	Minimum	Typical	Maximum	Units
f_{MAX}	Output Frequency				250	MHz
tp_{LH}	Propagation Delay, Low to High; NOTE 1		2.5	2.8	3.1	ns
tp_{HL}	Propagation Delay, High to Low; NOTE 1		2.6	2.8	3.0	ns
$t_{sk}(i)$	Input Skew; NOTE 2			45	150	ps
$t_{sk}(pp)$	Part-to-Part Skew; NOTE 2, 3				400	ps
t_R / t_F	Output Rise/Fall Time	20% to 80%	50		500	ps
odc	Output Duty Cycle		45		55	%
MUX_{ISOL}	MUX Isolation	@ 100MHz		45		dB

NOTE 1: Measured from $V_{DD}/2$ of the input to $V_{DDO}/2$ of the output.

NOTE 2: This parameter is defined in accordance with JEDEC Standard 65.

NOTE 3: Defined as skew between outputs on different devices operating at the same supply voltages and with equal load conditions. Using the same type of input on each device, the output is measured at $V_{DDO}/2$.

TABLE 5C. AC CHARACTERISTICS, $V_{DD} = 3.3V \pm 5\%$, $V_{DDO} = 1.8V \pm 0.2V$, $T_A = -40^\circ\text{C}$ TO 85°C

Symbol	Parameter	Test Conditions	Minimum	Typical	Maximum	Units
f_{MAX}	Output Frequency				250	MHz
tp_{LH}	Propagation Delay, Low to High; NOTE 1		2.7	3.2	3.8	ns
tp_{HL}	Propagation Delay, High to Low; NOTE 1		2.8	3.3	3.8	ns
$t_{sk}(i)$	Input Skew; NOTE 2			50	150	ps
$t_{sk}(pp)$	Part-to-Part Skew; NOTE 2, 3				475	ps
t_R / t_F	Output Rise/Fall Time	20% to 80%	100		700	ps
odc	Output Duty Cycle		45		55	%
MUX_{ISOL}	MUX Isolation	@ 100MHz		45		dB

NOTE 1: Measured from $V_{DD}/2$ of the input to $V_{DDO}/2$ of the output.

NOTE 2: This parameter is defined in accordance with JEDEC Standard 65.

NOTE 3: Defined as skew between outputs on different devices operating at the same supply voltages and with equal load conditions. Using the same type of input on each device, the output is measured at $V_{DDO}/2$.

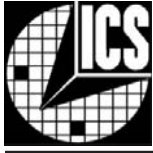

TABLE 5D. AC CHARACTERISTICS, $V_{DD} = V_{DDO} = 2.5V \pm 5\%$, $T_A = -40^{\circ}C$ TO $85^{\circ}C$

Symbol	Parameter	Test Conditions	Minimum	Typical	Maximum	Units
f_{MAX}	Output Frequency				250	MHz
tp_{LH}	Propagation Delay, Low to High; NOTE 1		2.5	3.0	3.5	ns
tp_{HL}	Propagation Delay, High to Low; NOTE 1		2.5	2.9	3.4	ns
$t_{sk}(i)$	Input Skew; NOTE 2			60	175	ps
$t_{sk}(pp)$	Part-to-Part Skew; NOTE 2, 3				300	ps
t_R / t_F	Output Rise/Fall Time	20% to 80%	100		500	ps
odc	Output Duty Cycle		40		60	%
MUX_{ISOL}	MUX Isolation	@ 100MHz		45		dB

NOTE 1: Measured from $V_{DD}/2$ of the input to $V_{DDO}/2$ of the output.

NOTE 2: This parameter is defined in accordance with JEDEC Standard 65.

NOTE 3: Defined as skew between outputs on different devices operating at the same supply voltages and with equal load conditions. Using the same type of input on each device, the output is measured at $V_{DDO}/2$.

TABLE 5E. AC CHARACTERISTICS, $V_{DD} = 2.5V \pm 5\%$, $V_{DDO} = 1.8V \pm -0.2V$, $T_A = -40^{\circ}C$ TO $85^{\circ}C$

Symbol	Parameter	Test Conditions	Minimum	Typical	Maximum	Units
f_{MAX}	Output Frequency				250	MHz
tp_{LH}	Propagation Delay, Low to High; NOTE 1		2.6	3.3	4.0	ns
tp_{HL}	Propagation Delay, High to Low; NOTE 1		2.7	3.3	4.0	ns
$t_{sk}(i)$	Input Skew; NOTE 2			50	150	ps
$t_{sk}(pp)$	Part-to-Part Skew; NOTE 2, 3				325	ps
t_R / t_F	Output Rise/Fall Time	20% to 80%	100		700	ps
odc	Output Duty Cycle		40		60	%
MUX_{ISOL}	MUX Isolation	@ 100MHz		45		dB

NOTE 1: Measured from $V_{DD}/2$ of the input to $V_{DDO}/2$ of the output.

NOTE 2: This parameter is defined in accordance with JEDEC Standard 65.

NOTE 3: Defined as skew between outputs on different devices operating at the same supply voltages and with equal load conditions. Using the same type of input on each device, the output is measured at $V_{DDO}/2$.

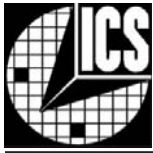

PARAMETER MEASUREMENT INFORMATION

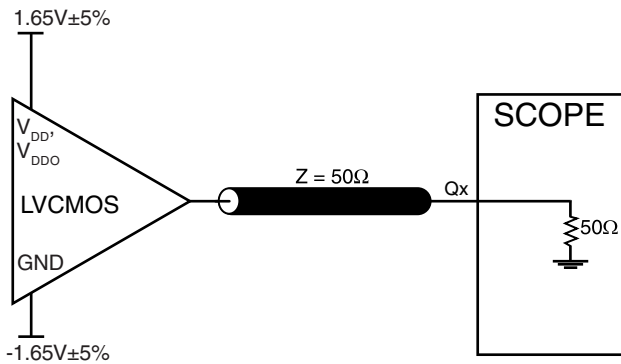

3.3V CORE/3.3V OUTPUT LOAD AC TEST CIRCUIT

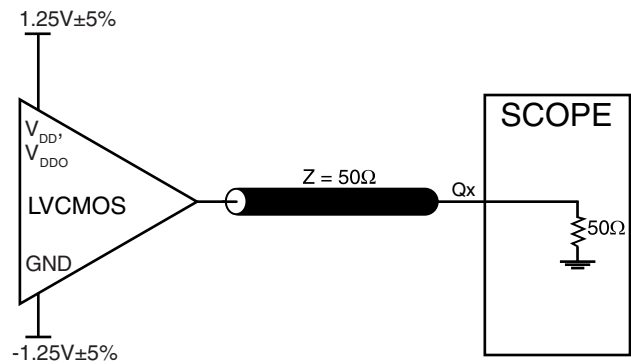

2.5V CORE/2.5V OUTPUT LOAD AC TEST CIRCUIT

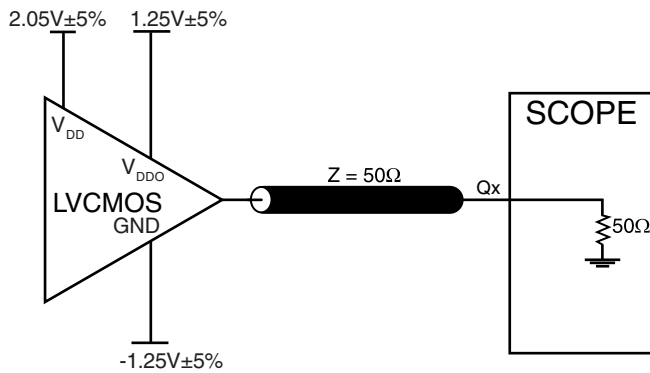

3.3V CORE/2.5V OUTPUT LOAD AC TEST CIRCUIT

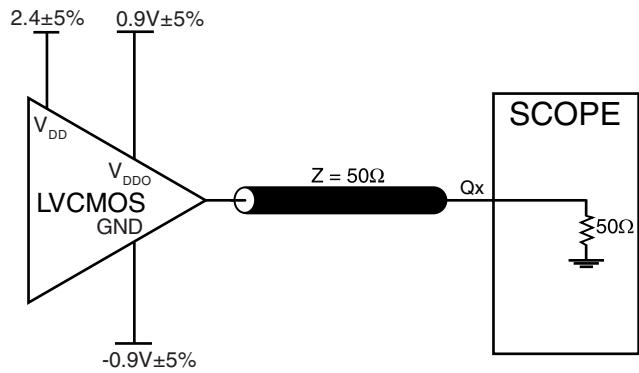

3.3V CORE/1.8V OUTPUT LOAD AC TEST CIRCUIT

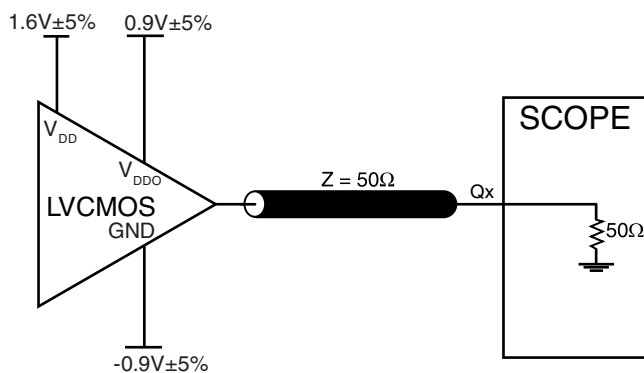

2.5 CORE/1.8V OUTPUT LOAD AC TEST CIRCUIT

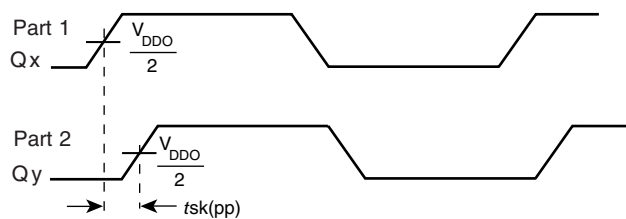

PART-TO-PART SKEW

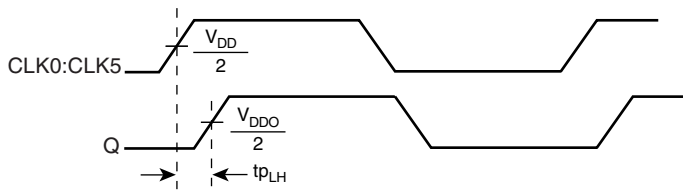

PROPAGATION DELAY

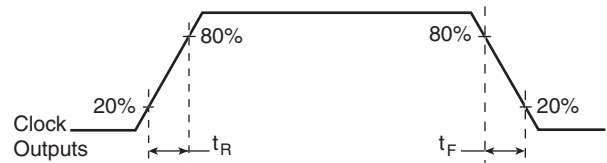

OUTPUT RISE/FALL TIME

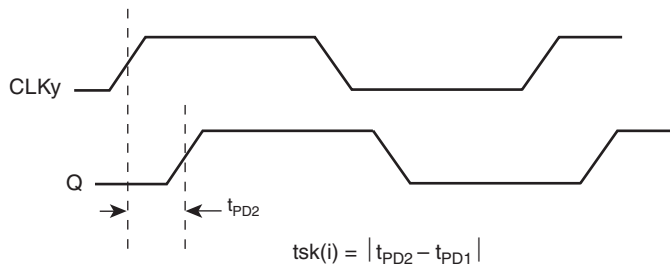
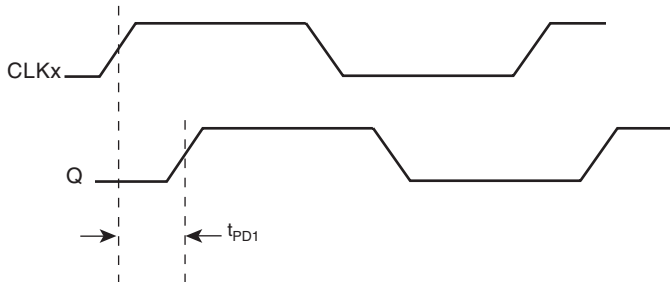

INPUT SKEW

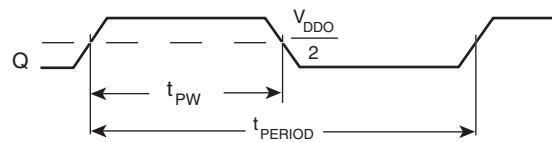

$$\text{odc} = \frac{t_{PW}}{t_{PERIOD}} \times 100\%$$

OUTPUT DUTY CYCLE/PULSE WIDTH/PERIOD



Integrated
Circuit
Systems, Inc.

ICS83056I
6:1, SINGLE-ENDED MULTIPLEXER

APPLICATION INFORMATION

RECOMMENDATIONS FOR UNUSED INPUT PINS

INPUTS:

CLK INPUT:

For applications not requiring the use of a clock input, it can be left floating. Though not required, but for additional protection, a 1k Ω resistor can be tied from the CLK input to ground.

LVC MOS CONTROL PINS:

All control pins have internal pull-ups or pull-downs; additional resistance is not required but can be added for additional protection. A 1k Ω resistor can be used.



Integrated
Circuit
Systems, Inc.

ICS83056I
6:1, SINGLE-ENDED MULTIPLEXER

RELIABILITY INFORMATION

TABLE 6. θ_{JA} VS. AIR FLOW TABLE FOR 16 LEAD TSSOP

θ_{JA} by Velocity (Linear Feet per Minute)			
	0	200	500
Single-Layer PCB, JEDEC Standard Test Boards	137.1°C/W	118.2°C/W	106.8°C/W
Multi-Layer PCB, JEDEC Standard Test Boards	89.0°C/W	81.8°C/W	78.1°C/W

NOTE: Most modern PCB designs use multi-layered boards. The data in the second row pertains to most designs.

TRANSISTOR COUNT

The transistor count for ICS83056I is: 874



PACKAGE OUTLINE - G SUFFIX FOR 16 LEAD TSSOP

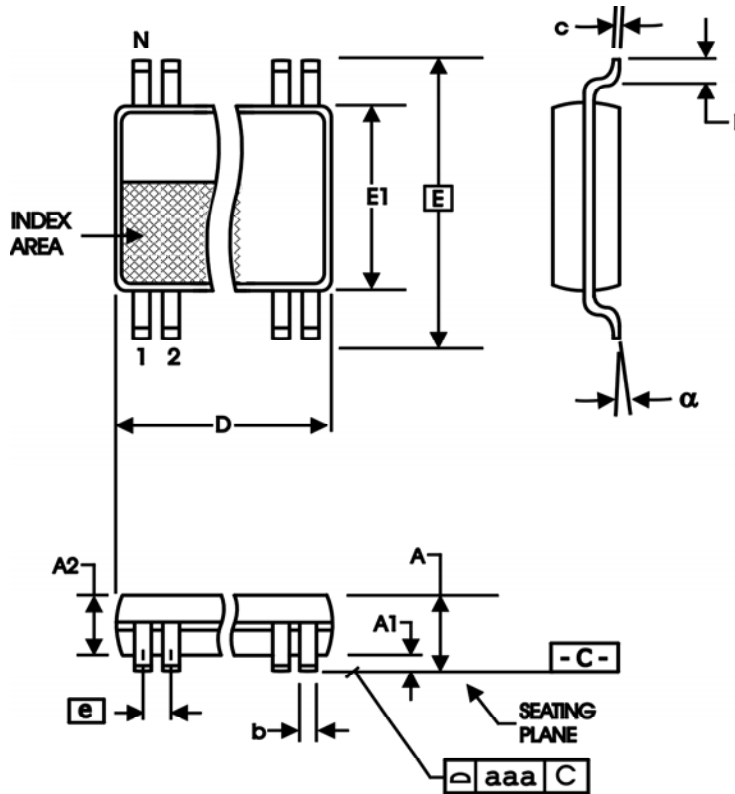

TABLE 7. PACKAGE DIMENSIONS

SYMBOL	Millimeters	
	Minimum	Maximum
N	16	
A	--	1.20
A1	0.05	0.15
A2	0.80	1.05
b	0.19	0.30
c	0.09	0.20
D	4.90	5.10
E	6.40 BASIC	
E1	4.30	4.50
e	0.65 BASIC	
L	0.45	0.75
α	0°	8°
aaa	--	0.10



Integrated
Circuit
Systems, Inc.

ICS83056I

6:1, SINGLE-ENDED MULTIPLEXER

TABLE 8. ORDERING INFORMATION

Part/Order Number	Marking	Package	Shipping Packaging	Temperature
ICS83056AGI	83056AGI	16 Lead TSSOP	tube	-40°C to 85°C
ICS83056AGIT	83056AGI	16 Lead TSSOP	2500 tape & reel	-40°C to 85°C
ICS83056AGILF	83056AIL	16 Lead "Lead-Free" TSSOP	tube	-40°C to 85°C
ICS83056AGILFT	83056AIL	16 Lead "Lead-Free" TSSOP	2500 tape & reel	-40°C to 85°C

NOTE: Parts that are ordered with an "LF" suffix to the part number are the Pb-Free configuration and are RoHS compliant.



Integrated
Circuit
Systems, Inc.

ICS83056I

6:1, SINGLE-ENDED MULTIPLEXER

REVISION HISTORY SHEET

Rev	Table	Page	Description of Change	Date
A	T8	12	Ordering Information Table - added Lead-Free marking.	1/18/06