

International
IR Rectifier

PD - 97110

iP2001PbF

iPOWIR™
TECHNOLOGY

**Synchronous Buck
Multiphase Optimized BGA Power Block**
Integrated Power Semiconductors, Drivers & Passives

Features:

- 20A continuous output current with no derating up to $T_{PCB} = 90^{\circ}\text{C}$
- Very small 11mm x 11mm x 3mm profile
- Internal features minimize layout sensitivity *
- Optimized for very low power losses
- 3.3 to 12V input voltage



iP2001PbF Power Block

Description

The iP2001PbF is a fully optimized solution for high current synchronous buck multiphase applications. Board space and design time are greatly reduced because most of the components required for each phase of a typical discrete-based multiphase circuit are integrated into a single 11mm x 11mm x 3mm BGA power block. The only additional components required for a complete multiphase converter are a PWM IC, the external inductors, and the input and output capacitors.

iPOWIR technology offers designers an innovative board space saving solution for applications requiring high power densities. iPOWIR technology eases design for applications where component integration offers benefits in performance and functionality. iPOWIR technology solutions are also optimized internally for layout, heat transfer and component selection.

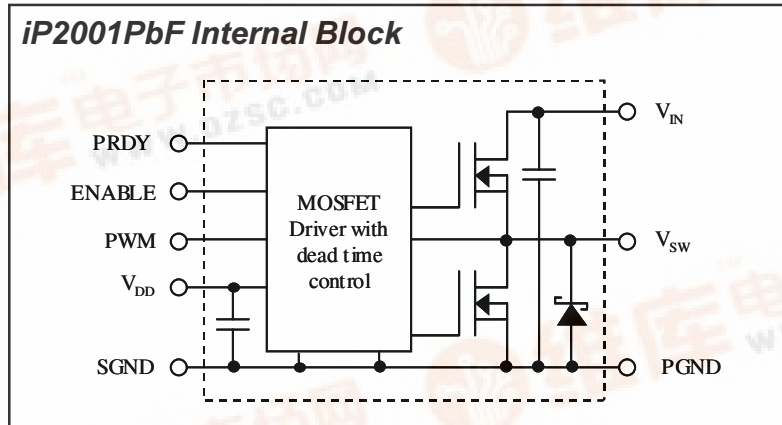

PACKAGE DESCRIPTION	INTERFACE CONNECTION	PARTS PER BAG	PARTS PER REEL	T & R ORIENTATION
iP2001PbF	BGA	10	---	Fig 12
iP2001TRPbF	BGA	---	1000	

* All of the difficult PCB layout and bypassing issues have been addressed with the internal design of the iPOWIR Block. There are no concerns about double pulsing, unwanted shutdown, or other malfunctions which often occur in switching power supplies. The iPOWIR Block will function normally without any additional input power supply bypass capacitors. However, for reliable long term operation it is recommended that the adequate amount of input decoupling is provided on the V_{IN} pin. No additional bypassing is required on the V_{DD} pin.



iP2001PbF All specifications @ 25°C (unless otherwise specified)

Absolute Maximum Ratings :

Parameter	Min	Typ	Max	Units	Conditions
V _{IN} to PGND	-	-	16	V	
V _{DD} to SGND	-	-	6.0	V	
PWM to SGND	-0.3	-	V _{DD} +0.3	V	not to exceed 6.0V
Enable to SGND	-0.3	-	V _{DD} +0.3	V	not to exceed 6.0V
Output RMS Current	-	-	20	A	
Storage Temperature	-40	-	125	°C	

Recommended Operating Conditions :

Parameter	Symbol	Min	Typ	Max	Units	Conditions
Supply Voltage	V _{DD}	4.6	5.0	5.5	V	
Input Voltage Range	V _{IN}	3.0	-	12.6	V	
Output Voltage Range	V _{OUT}	0.9	-	3.3	V	see Figs. 2 & 4
Output Current Range	I _{OUT}	-	-	20	A	see Fig. 2
Operating Frequency	f _{sw}	150	-	1000	kHz	see Figs. 2 & 5
Operating Duty Cycle	D	-	-	85	%	

Electrical Specifications @ V_{DD} = 5V (unless otherwise specified) :

Parameter	Symbol	Min	Typ	Max	Units	Conditions
Block Power Loss ①	P _{BLK}	-	3.1	3.8	W	V _{IN} = 12V, V _{OUT} = 1.6V, I _{OUT} = 20A, f _{sw} = 500kHz
Turn On Delay ②	t _{d(on)}	-	63	-	ns	
Turn Off Delay ②	t _{d(off)}	-	26	-	ns	
V _{IN} Quiescent Current	I _{Q-VIN}	-	-	1.0	mA	Enable = 0V, V _{IN} = 12V
V _{DD} Quiescent Current	I _{Q-VDD}	-	-	10	μA	Enable = 0V, V _{DD} = 5V
Under Voltage Lockout	Start Threshold	V _{START}	4.2	4.4	4.5	V
	Hysteresis	V _{HYS-UVLO}	-	.05	-	
Enable	Input Voltage High	V _{IH}	2.0	-	-	V
	Input Voltage Low	V _{IL}	-	-	0.8	
Power Ready	Logic Level High	V _{QH}	4.5	4.6	-	V
	Logic Level Low	V _{QL}	-	0.1	0.2	
PWM nput	Logic Level High	V _{QH}	2.0	-	-	V
	Logic Level Low	V _{QL}	-	-	0.8	

① Measurement were made using four 10uF (TDK C3225X7R1C106M or equiv.) capacitors across the input (see Fig. 8).

② Not associated with the rise and fall times. Does not affect Power Loss (see Fig. 9).

Pin Description Table

Pin Name	Ball Designator	Pin Function
V _{DD}	A1 – A3, B1 – B3	Supply voltage for the internal circuitry.
V _{IN}	A5 – A12, B5 – B12, C5 - C10	Input voltage for the DC-DC converter.
PGND	C11, C12, D11, D12, E11, E12, F6, F7, F12, G6, G7, G12, H6, H7, H12, J6, J7, J12, K5 – K7, K12, L5, L6, L12, M5 – M7, M12	Power Ground - connection to the ground of bulk and filter capacitors.
V _{SW}	D5 – D10, E5 – E10, F8 – F11, G8 – G11, H8 – H11, J8 – J11, K8 – K11, L8 – L11, M8 – M11	Switching Node - connection to the output inductor.
SGND	C1 – C3, D1 –D3, E1 –E3	Signal Ground.
ENABLE	F1	When set to logic level high, internal circuitry of the device is enabled. When set to logic level low, the PRDY pin is forced low, the Control and Synchronous switches are turned off, and the supply current is less than 10μA.
PRDY	K1	Power Ready - This pin indicates the status of ENABLE or V _{DD} . This output will be driven low when ENABLE is logic low or when V _{DD} is less than 4.4V (typ.). When ENABLE is logic high and V _{DD} is greater than 4.4V (typ.), this output is driven high. This output has a 10mA source and 1mA sink capability.
PWM	H1	TTL-level input signal to MOSFET drivers.
NC	B4, C4, D4, E4, F2 – F4, G2 – G4, H2 – H4, J1, J2 – J4, K3, L1, L2, M1 – M4	This pin is not for electrical connection. It should be attached only to dead copper.

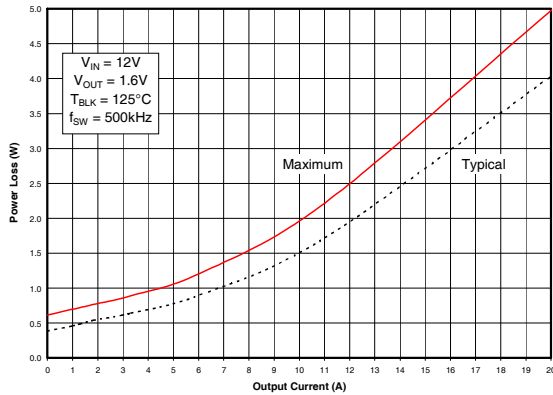

Fig 1. Power Loss vs. Current

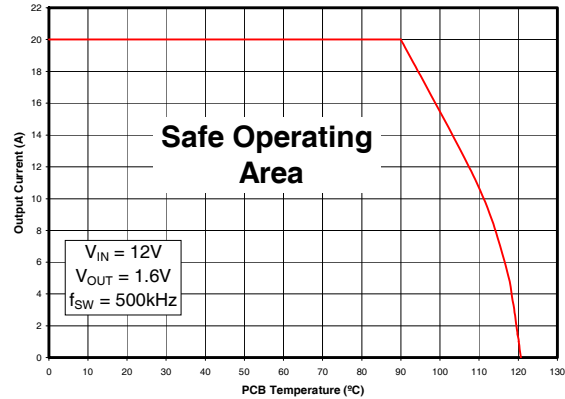

Fig 2. Safe Operating Area (SOA) vs. T_{PCB}^*
(*see AN-1030 for details)

Adjusting the Power Loss and SOA curves for different operating conditions

To make adjustments to the power loss curves in Fig. 1, multiply the normalized value obtained from the curves in Figs. 3, 4, 5 or 6 by the value indicated on the power loss curve in Fig. 1. If multiple adjustments are required, multiply all of the normalized values together, then multiply that product by the value indicated on the power loss curve in Fig. 1. The resulting product is the final power loss based on all factors.

To make adjustments to the SOA curve in Fig. 2, determine the maximum allowed PCB temperature in Fig. 2 at the required operating current. Then, add the correction temperature from the normalized curves in Figs. 3, 4, 5 or 6 to find the final maximum allowable PCB temperature. When multiple adjustments are required, add all of the temperatures together, then add the sum to the PCB temperature indicated on the SOA graph to determine the final maximum allowable PCB temperature based on all factors.

Operating Conditions for the examples below:

Output Current = 20A	Input Voltage = 7V
Output Voltage = 2.5V	Sw Freq= 750kHz

Adjusting for Maximum Power Loss:

- (Fig. 1) Maximum power loss = 5W
- (Fig. 3) Normalized power loss for input voltage ≈ 0.925
- (Fig. 4) Normalized power loss for output voltage ≈ 1.1
- (Fig. 5) Normalized power loss for frequency ≈ 1.225

$$\text{Adjusted Power Loss} = 5W \times 1.1 \times 0.925 \times 1.225 \approx \underline{6.23W}$$

Adjusting for SOA Temperature:

- (Fig. 2) SOA PCB Temperature = 90°C
- (Fig. 3) Normalized SOA PCB Temperature for input voltage $\approx 2.6^\circ\text{C}$
- (Fig. 4) Normalized SOA PCB Temperature for output voltage $\approx -3.5^\circ\text{C}$
- (Fig. 5) Normalized SOA PCB Temperature for frequency $\approx -7.5^\circ\text{C}$

$$\text{Adjusted SOA PCB Temperature} = 90^\circ\text{C} - 3.5^\circ\text{C} + 2.6^\circ\text{C} - 7.5^\circ\text{C} \approx \underline{81.6^\circ\text{C}}$$

Typical Performance Curves

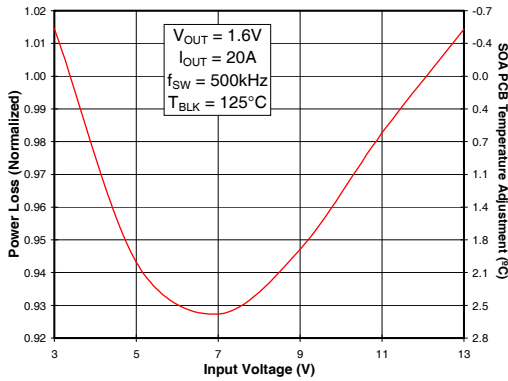

Fig 3. Normalized Power Loss vs. V_{IN}

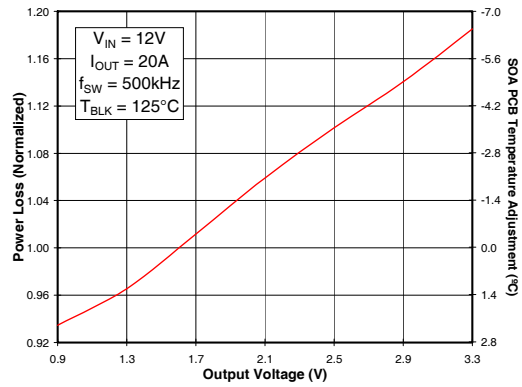

Fig 4. Normalized Power Loss vs. V_{OUT}

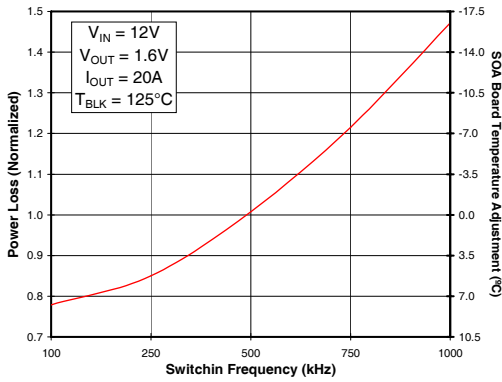

Fig 5. Normalized Power Loss vs. Frequency

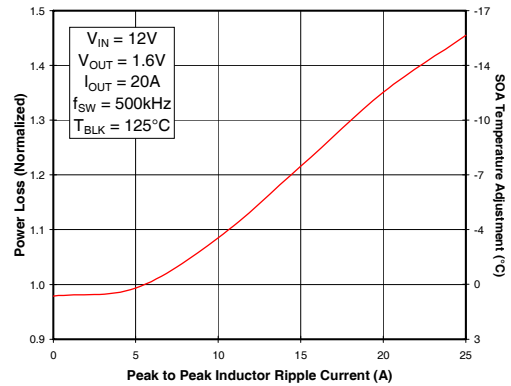

Fig 6. Normalized Power Loss vs. Ripple Current

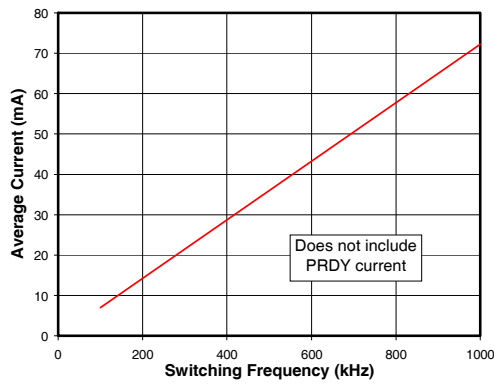
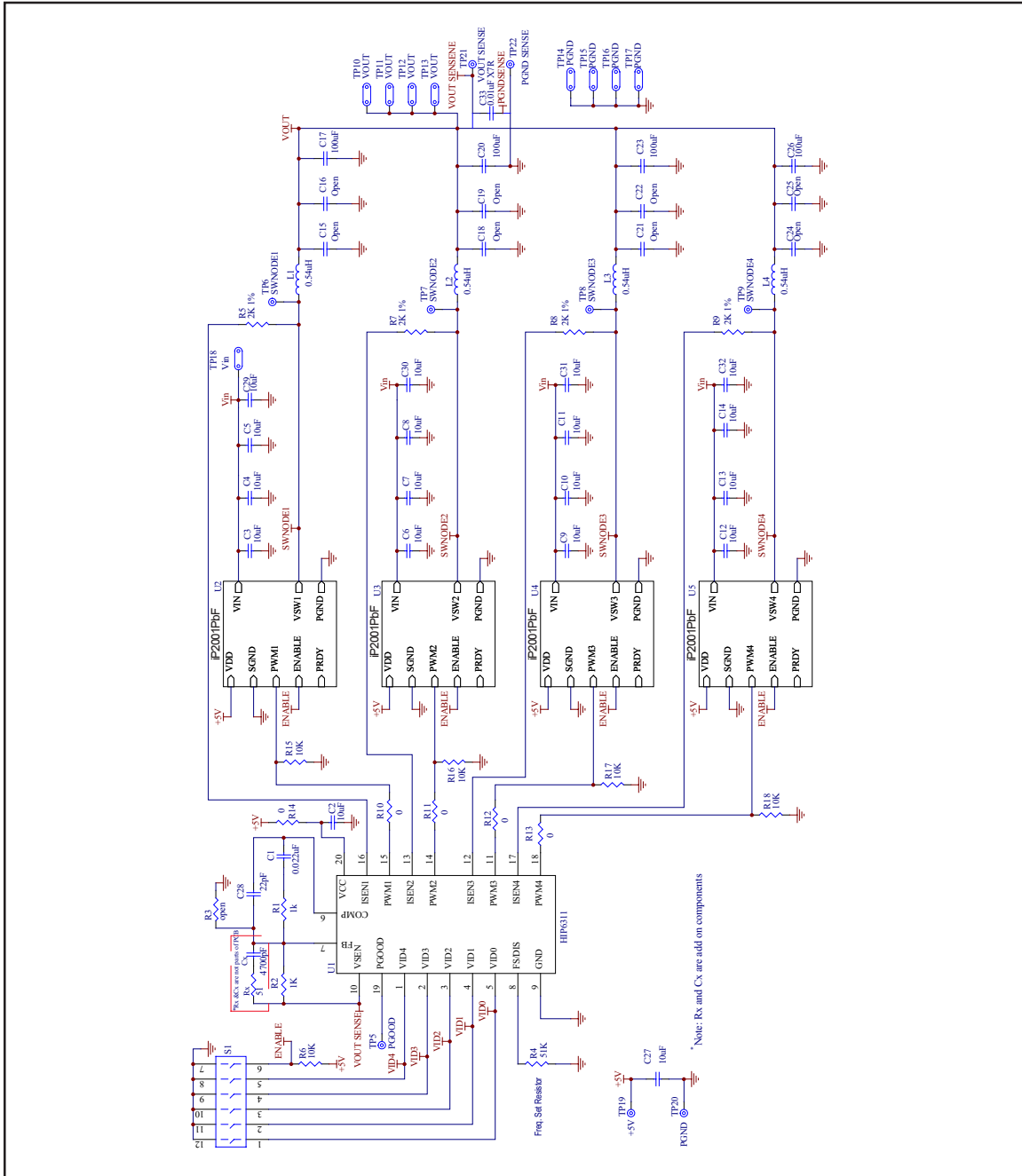

Fig 7. I_{DD} vs. Frequency



4-Phase Reference Design Schematic

Designator	Value 1	Value 2	Type	Tolerance	Package	Mfr.	Mfr. Part No.
C1	0.022uF	50V	X7R	10%	0805	TDK	C2012X7R1H223K
C2 - C14, C27, C29 - C32	10.0uF	16V	X5R	10%	1210	TDK	C3225X5R1C106K
C15, C16, C18, C19, C21, C22, C24, C25, D1 - D4, R3, R19	-	-	-	-	-	-	-
C17, C20, C23, C26	100uF	6.3V	X5R	10%	2220	TDK	C5750X5R0J107K
C28	22.0pF	50V	COG	5%	0805	TDK	C2012COG1H220J
C33	0.010uF	50V	X7R	10%	0805	TDK	C2012X7R1H103K
Cx	4700pF	50V	X7R	10%	0603	TDK	C1608X7R1H472K
L1 - L4	0.54uH	27A	Ferrite	20%	SMT	Panasonic	ETQP6F0R6BFA
R1, R2	1K	1/8W	Thick film	5%	0805	ROHM	MCR10EZJH102
R10 - R14	0	1/8W	Thick film	<50m	0805	ROHM	MCR10EZJH000
R6, R15 - R18	10K	1/8W	Thick film	5%	0805	ROHM	MCR10EZJH103
R4	51K	1/8W	Thick film	5%	0805	ROHM	MCR10EZJH513
R5, R7, R8, R9	2K	1/8W	Thick film	5%	0805	ROHM	MCR10EZJH202
Rx	51	1/10W	Thick film	5%	0603	KOA	RM73B1J510J
S1	SPST	6 position	Switch	-	SMT	C&K Components	SD06H0SK
ST1 - ST4	4-40	-	-	-	-	Keystone	8412
U1	-	-	PWM controller	0 - 70°C	SOIC20	Intersil	HIP6311CB
U2 - U5	-	-	DC-DC	-	11 x 11 x 3mm	IR	iP2001PbF

4-Phase Reference Design Bill of Materials

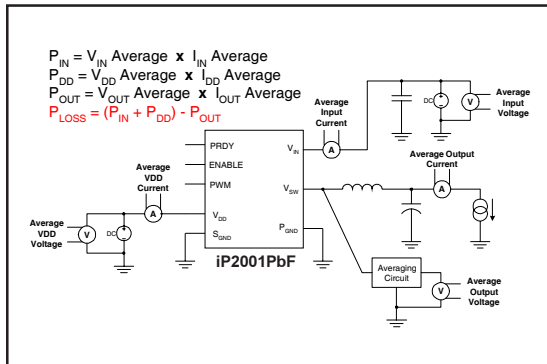

Fig 8. Power Loss Test Circuit

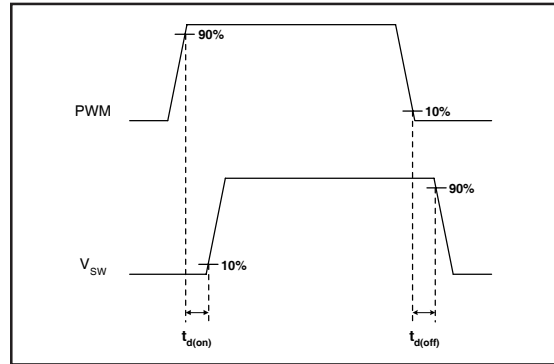
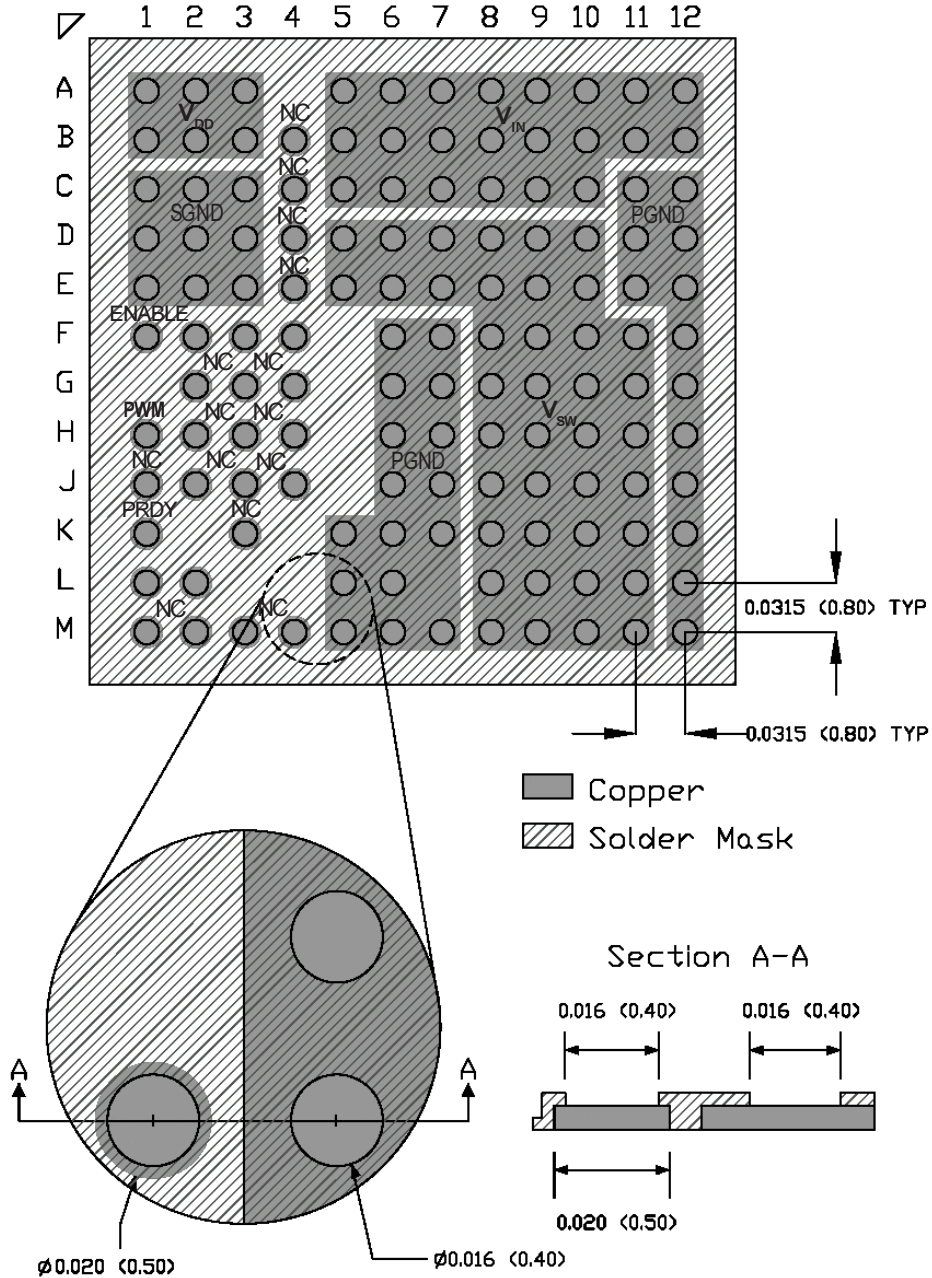

Fig 9. Timing Diagram



Recommended PCB Footprint (Top View)

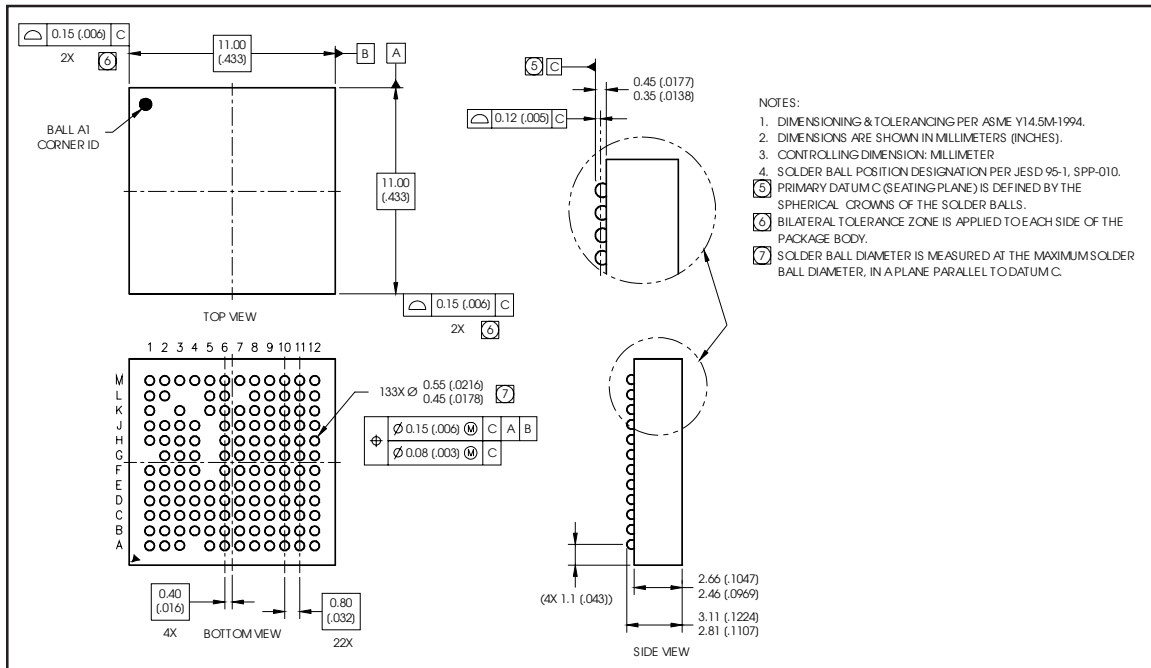

Fig. 10: Mechanical Drawing

Refer to the following application notes for detailed guidelines and suggestions when implementing iPOWIR Technology products:

AN-1028: Recommended Design, Integration and Rework Guidelines for International Rectifier's BGA and LGA Packages

This paper discusses optimization of the layout design for mounting iPowIR BGA and LGA packages on printed circuit boards, accounting for thermal and electrical performance and assembly considerations. Topics discussed includes PCB layout placement, routing, and via interconnect suggestions, as well as soldering, pick and place, reflow, cleaning and reworking recommendations.

AN-1029: Optimizing a PCB Layout for an iPOWIR Technology Design

This paper describes how to optimize the PCB layout design for both thermal and electrical performance. This includes placement, routing, and via interconnect suggestions.

AN-1030: Applying iPOWIR Products in Your Thermal Environment

This paper explains how to use the Power Loss and SOA curves in the data sheet to validate if the operating conditions and thermal environment are within the Safe Operating Area of the iPOWIR product.

iP2001PbF

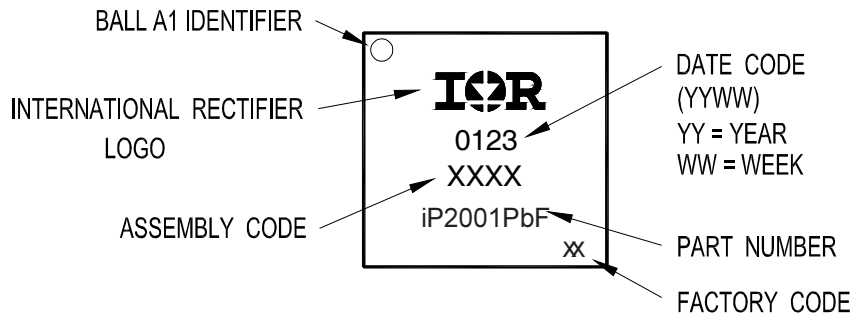

Fig.11: Part Marking

xx

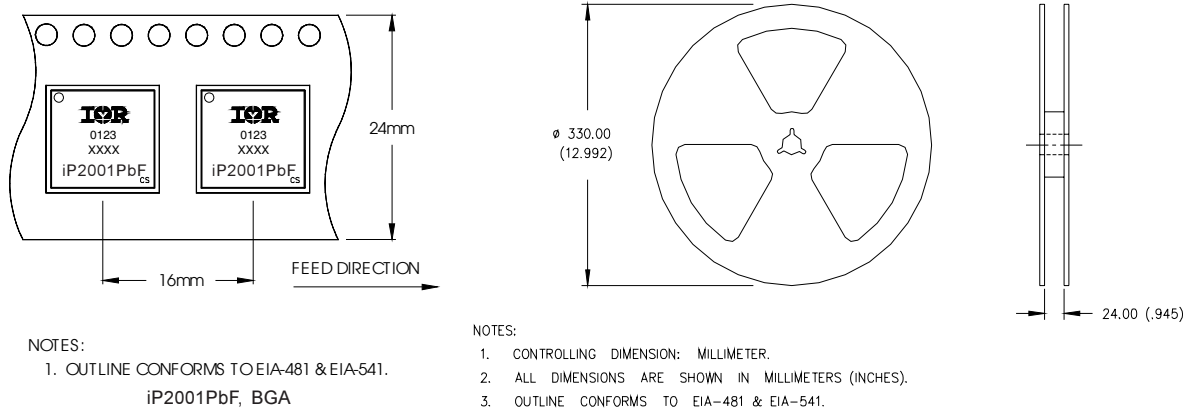

Fig.12: Tape & Reel Information

*Data and specifications subject to change without notice.
This product has been designed and qualified for the industrial market.
Qualification Standards can be found on IR's Web site.*

IR WORLD HEADQUARTERS: 233 Kansas St., El Segundo, California 90245, USA Tel: (310) 252-7105
TAC Fax: (310) 252-7903

Visit us at www.irf.com for sales contact information.08/06