

# International IR Rectifier

PD - 95416

# IRFB9N65APbF

SMPS MOSFET HEXFET® Power MOSFET

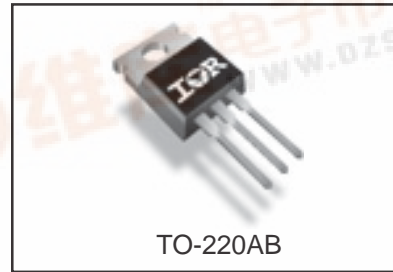
### Applications

- Switch Mode Power Supply (SMPS)
- Uninterruptible Power Supply
- High Speed Power Switching
- Lead-Free

<b>V<sub>DSS</sub></b>	<b>R<sub>DS(on) max</sub></b>	<b>I<sub>D</sub></b>
<b>650V</b>	<b>0.93Ω</b>	<b>8.5A</b>

### Benefits

- Low Gate Charge Qg results in Simple Drive Requirement
- Improved Gate, Avalanche and Dynamic dv/dt Ruggedness
- Fully Characterized Capacitance and Avalanche Voltage and Current



### Absolute Maximum Ratings

	Parameter	Max.	Units
I <sub>D</sub> @ T <sub>C</sub> = 25°C	Continuous Drain Current, V <sub>GS</sub> @ 10V	8.5	A
I <sub>D</sub> @ T <sub>C</sub> = 100°C	Continuous Drain Current, V <sub>GS</sub> @ 10V	5.4	
I <sub>DM</sub>	Pulsed Drain Current ①②	21	
P <sub>D</sub> @ T <sub>C</sub> = 25°C	Power Dissipation	167	W
	Linear Derating Factor	1.3	W/°C
V <sub>GS</sub>	Gate-to-Source Voltage	± 30	V
dv/dt	Peak Diode Recovery dv/dt ③④	2.8	V/ns
T <sub>J</sub>	Operating Junction and Storage Temperature Range	-55 to + 150	°C
T <sub>STG</sub>			
	Soldering Temperature, for 10 seconds	300 (1.6mm from case )	
	Mounting torque, 6-32 or M3 screw	10 lbf•in (1.1N•m)	

### Typical SMPS Topologies

- Single Transistor Flyback
- Single Transistor Forward

Notes ① through ⑤ are on page 8  
www.irf.com



# IRFB9N65APbF

International  
IR Rectifier

Static @  $T_J = 25^\circ\text{C}$  (unless otherwise specified)

	Parameter	Min.	Typ.	Max.	Units	Conditions
$V_{(BR)DSS}$	Drain-to-Source Breakdown Voltage	650	—	—	V	$V_{GS} = 0V, I_D = 250\mu A$
$\Delta V_{(BR)DSS}/\Delta T_J$	Breakdown Voltage Temp. Coefficient	—	0.67	—	V/°C	Reference to $25^\circ\text{C}, I_D = 1\text{mA}$ Ⓞ
$R_{DS(on)}$	Static Drain-to-Source On-Resistance	—	—	0.93	$\Omega$	$V_{GS} = 10V, I_D = 5.1\text{A}$ ④
$V_{GS(th)}$	Gate Threshold Voltage	2.0	—	4.0	V	$V_{DS} = V_{GS}, I_D = 250\mu A$
$I_{DSS}$	Drain-to-Source Leakage Current	—	—	25	$\mu A$	$V_{DS} = 650V, V_{GS} = 0V$
		—	—	250		$V_{DS} = 520V, V_{GS} = 0V, T_J = 125^\circ\text{C}$
$I_{GSS}$	Gate-to-Source Forward Leakage	—	—	100	nA	$V_{GS} = 30V$
	Gate-to-Source Reverse Leakage	—	—	-100		$V_{GS} = -30V$

Dynamic @  $T_J = 25^\circ\text{C}$  (unless otherwise specified)

	Parameter	Min.	Typ.	Max.	Units	Conditions
$g_{fs}$	Forward Transconductance	3.9	—	—	S	$V_{DS} = 50V, I_D = 3.1\text{A}$ Ⓞ
$Q_g$	Total Gate Charge	—	—	48	nC	$I_D = 5.2\text{A}$
$Q_{gs}$	Gate-to-Source Charge	—	—	12		$V_{DS} = 400V$
$Q_{gd}$	Gate-to-Drain ("Miller") Charge	—	—	19	ns	$V_{GS} = 10V$ , See Fig. 6 and 13 ④Ⓞ
$t_{d(on)}$	Turn-On Delay Time	—	14	—		$V_{DD} = 325V$
$t_r$	Rise Time	—	20	—		$I_D = 5.2\text{A}$
$t_{d(off)}$	Turn-Off Delay Time	—	34	—		$R_G = 9.1\Omega$
$t_f$	Fall Time	—	18	—		$R_D = 62\Omega$ , See Fig. 10 ④Ⓞ
$C_{iss}$	Input Capacitance	—	1417	—		pF
$C_{oss}$	Output Capacitance	—	177	—	$V_{DS} = 25V$	
$C_{rss}$	Reverse Transfer Capacitance	—	7.0	—	$f = 1.0\text{MHz}$ , See Fig. 5Ⓞ	
$C_{oss}$	Output Capacitance	—	1912	—	$V_{GS} = 0V, V_{DS} = 1.0V, f = 1.0\text{MHz}$	
$C_{oss}$	Output Capacitance	—	48	—	$V_{GS} = 0V, V_{DS} = 520V, f = 1.0\text{MHz}$	
$C_{oss\ eff.}$	Effective Output Capacitance	—	84	—	$V_{GS} = 0V, V_{DS} = 0V$ to $520V$ ④Ⓞ	

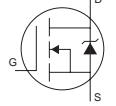
## Avalanche Characteristics

	Parameter	Typ.	Max.	Units
$E_{AS}$	Single Pulse Avalanche EnergyⓄ	—	325	mJ
$I_{AR}$	Avalanche CurrentⓄ	—	5.2	A
$E_{AR}$	Repetitive Avalanche EnergyⓄ	—	16	mJ

## Thermal Resistance

	Parameter	Typ.	Max.	Units
$R_{\theta JC}$	Junction-to-Case	—	0.75	°C/W
$R_{\theta CS}$	Case-to-Sink, Flat, Greased Surface	0.50	—	
$R_{\theta JA}$	Junction-to-Ambient	—	62	

## Diode Characteristics

	Parameter	Min.	Typ.	Max.	Units	Conditions
$I_S$	Continuous Source Current (Body Diode)	—	—	5.2	A	MOSFET symbol showing the integral reverse p-n junction diode. 
$I_{SM}$	Pulsed Source Current (Body Diode) ①	—	—	21		
$V_{SD}$	Diode Forward Voltage	—	—	1.5	V	$T_J = 25^\circ\text{C}, I_S = 5.2\text{A}, V_{GS} = 0V$ ④
$t_{rr}$	Reverse Recovery Time	—	493	739	ns	$T_J = 25^\circ\text{C}, I_F = 5.2\text{A}$
$Q_{rr}$	Reverse Recovery Charge	—	2.1	3.2	$\mu C$	$di/dt = 100\text{A}/\mu s$ ④Ⓞ
$t_{on}$	Forward Turn-On Time	Intrinsic turn-on time is negligible (turn-on is dominated by $L_S+L_D$ )				

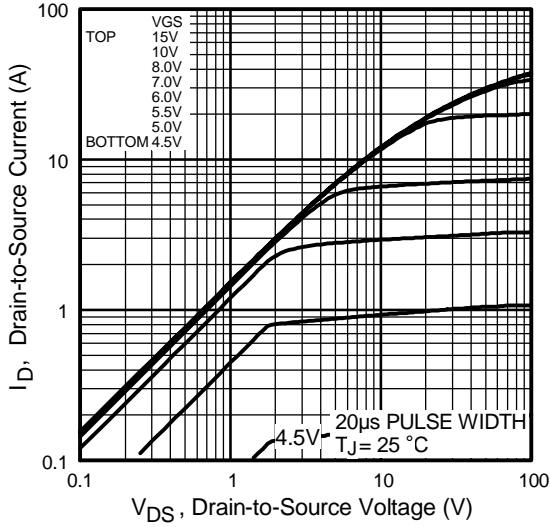


Fig 1. Typical Output Characteristics

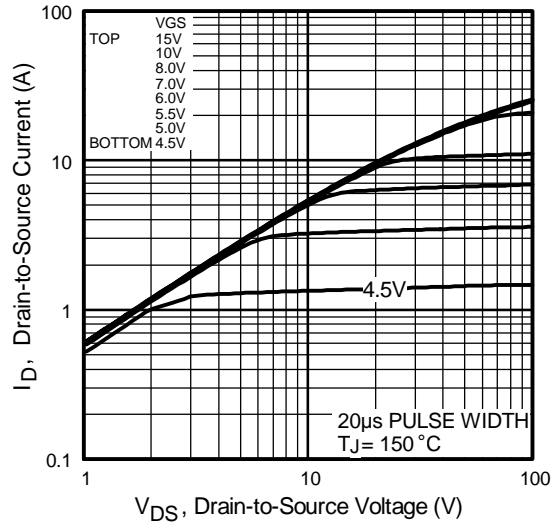


Fig 2. Typical Output Characteristics

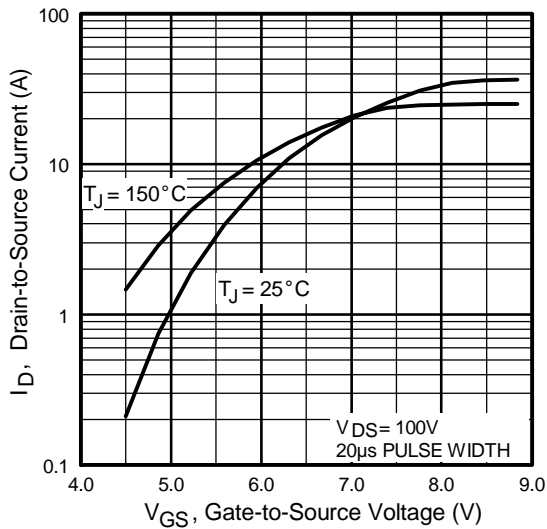


Fig 3. Typical Transfer Characteristics

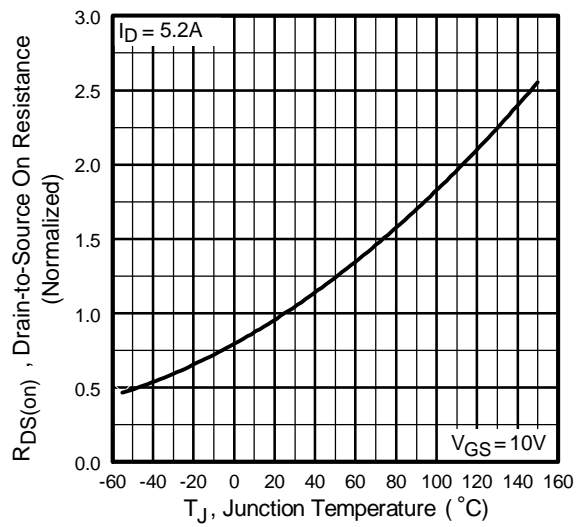
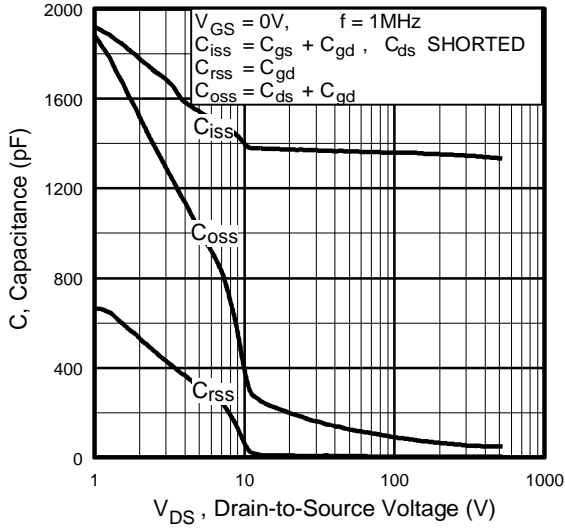
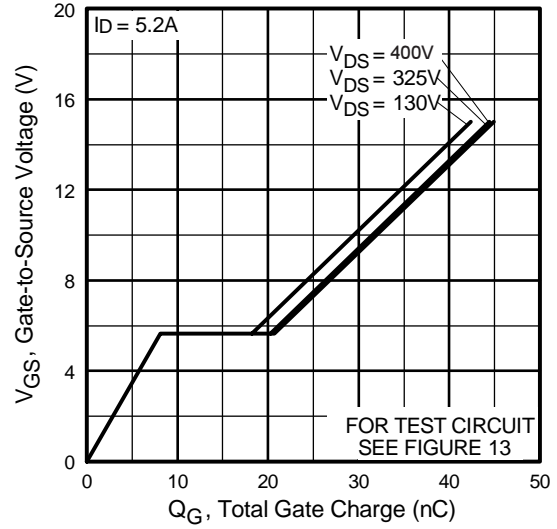


Fig 4. Normalized On-Resistance Vs. Temperature

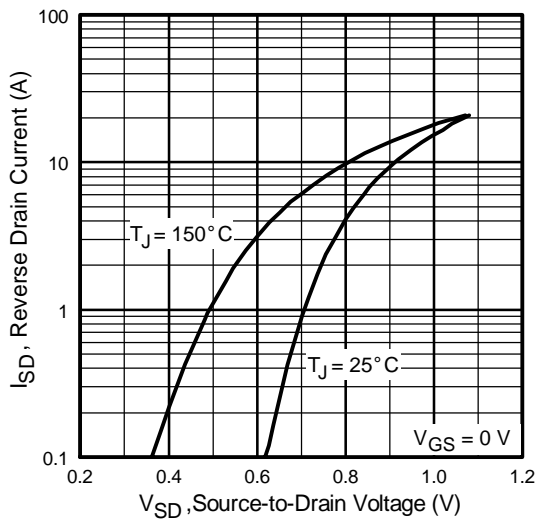
# IRFB9N65APbF



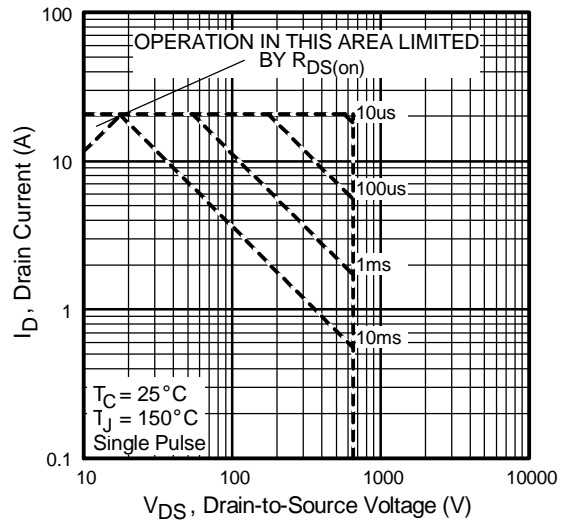
**Fig 5.** Typical Capacitance Vs. Drain-to-Source Voltage



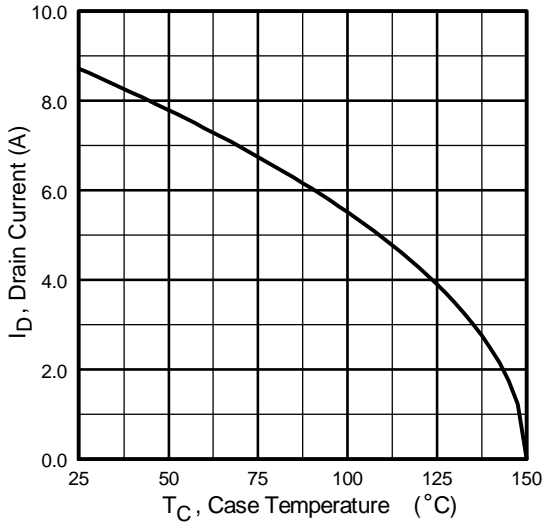
**Fig 6.** Typical Gate Charge Vs. Gate-to-Source Voltage



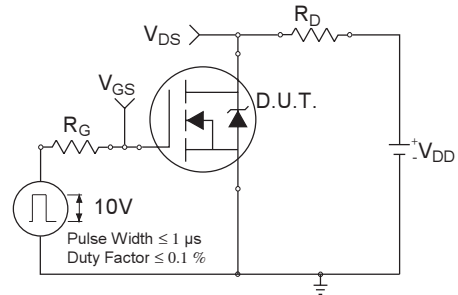
**Fig 7.** Typical Source-Drain Diode Forward Voltage



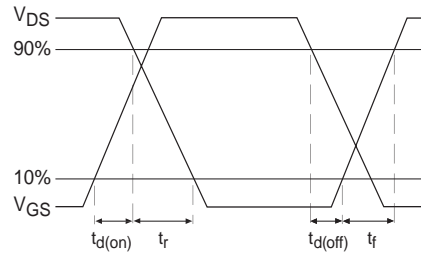
**Fig 8.** Maximum Safe Operating Area



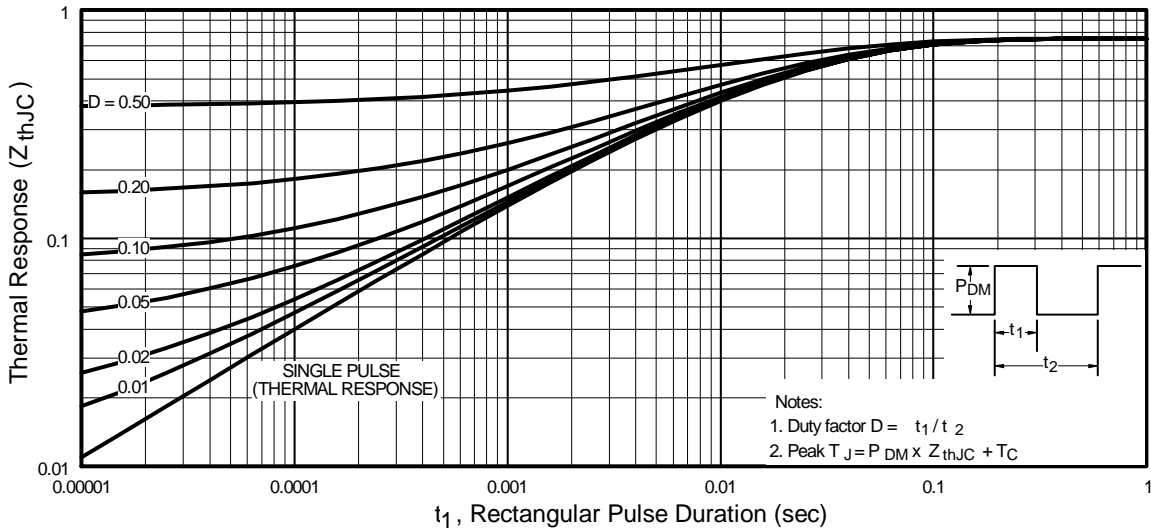
**Fig 9.** Maximum Drain Current Vs. Case Temperature



**Fig 10a.** Switching Time Test Circuit



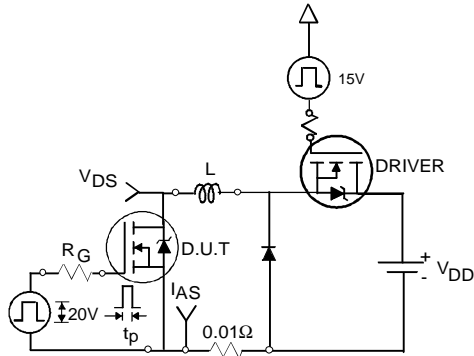
**Fig 10b.** Switching Time Waveforms



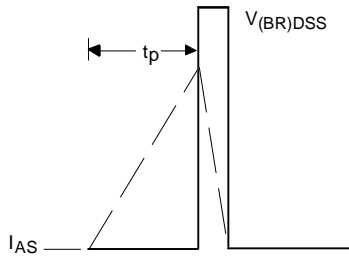
**Fig 11.** Maximum Effective Transient Thermal Impedance, Junction-to-Case

# IRFB9N65APbF

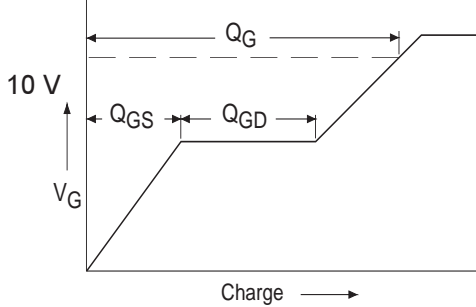
International  
**IR** Rectifier



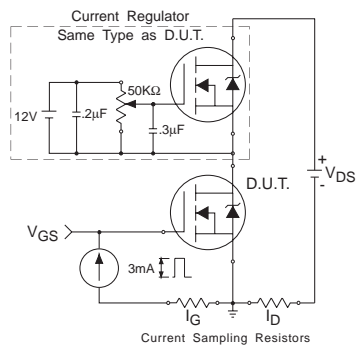
**Fig 12a.** Unclamped Inductive Test Circuit



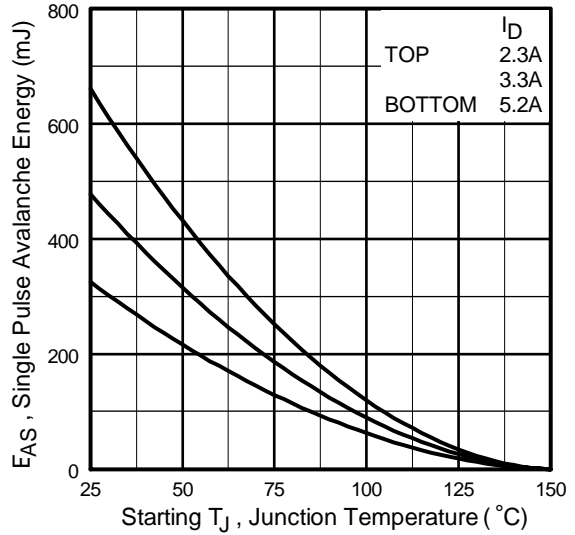
**Fig 12b.** Unclamped Inductive Waveforms



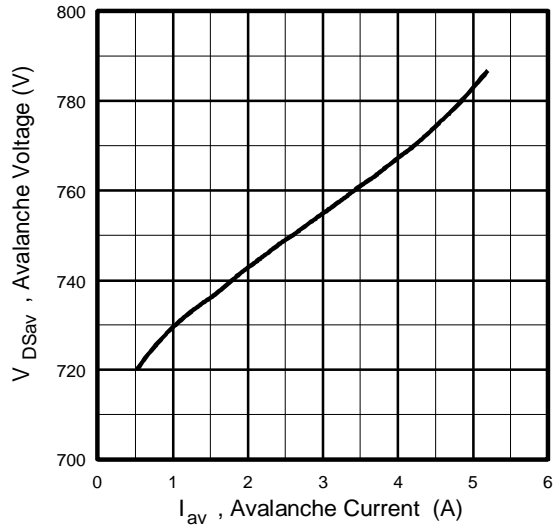
**Fig 13a.** Basic Gate Charge Waveform



**Fig 13b.** Gate Charge Test Circuit

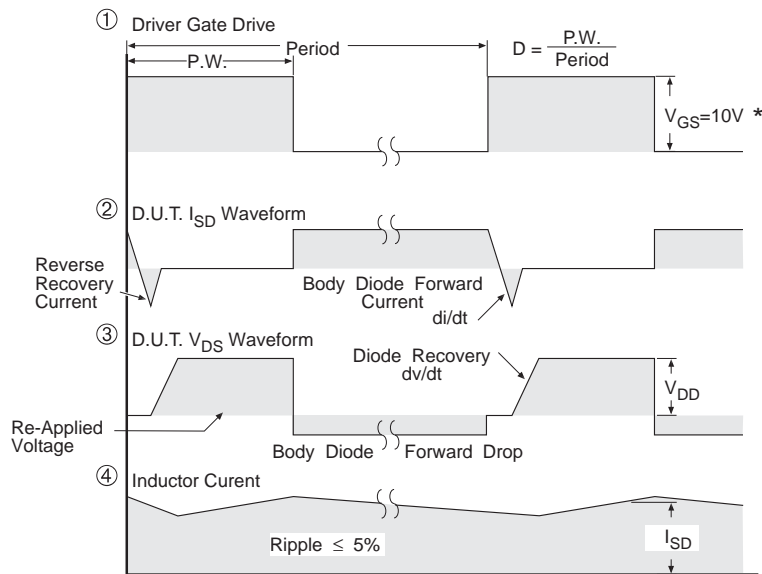
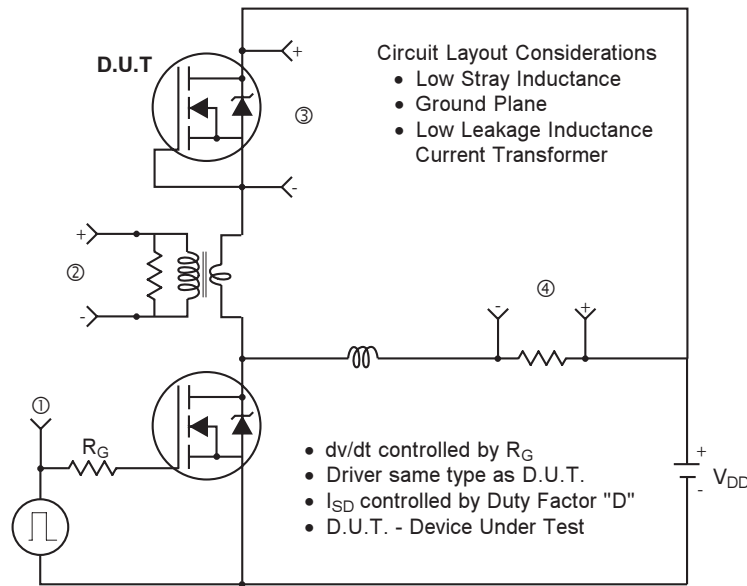


**Fig 12c.** Maximum Avalanche Energy Vs. Drain Current



**Fig 12d.** Typical Drain-to-Source Voltage Vs. Avalanche Current

## Peak Diode Recovery dv/dt Test Circuit



\*  $V_{GS} = 5V$  for Logic Level Devices

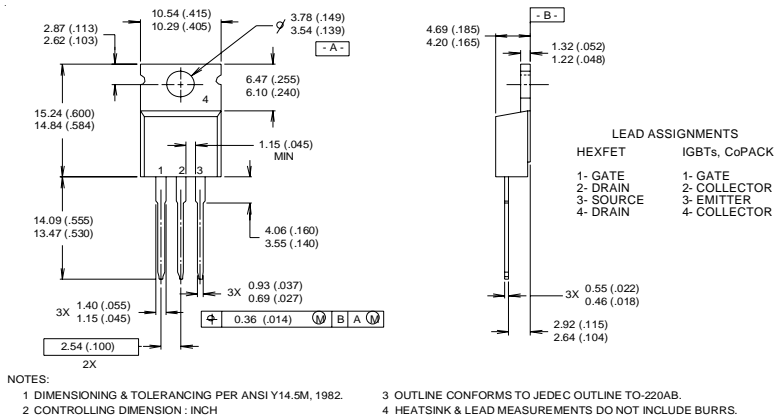
**Fig 14.** For N-Channel HEXFET® Power MOSFETs

# IRFB9N65APbF

## TO-220AB Package Outline

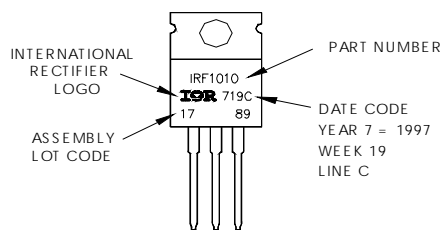
Dimensions are shown in millimeters (inches)

International  
**IR** Rectifier



## TO-220AB Part Marking Information

EXAMPLE: THIS IS AN IRF1010  
 LOT CODE 1789  
 ASSEMBLED ON WW 19, 1997  
 IN THE ASSEMBLY LINE "C"  
**Note:** "P" in assembly line position indicates "Lead-Free"



### Notes:

- ① Repetitive rating; pulse width limited by max. junction temperature. (See fig. 11)
- ② Starting  $T_J = 25^\circ\text{C}$ ,  $L = 24\text{mH}$   
 $R_G = 25\Omega$ ,  $I_{AS} = 5.2\text{A}$ . (See Figure 12)
- ③  $I_{SD} \leq 5.2\text{A}$ ,  $di/dt \leq 90\text{A}/\mu\text{s}$ ,  $V_{DD} \leq V_{(BR)DSS}$ ,  
 $T_J \leq 150^\circ\text{C}$
- ④ Pulse width  $\leq 300\mu\text{s}$ ; duty cycle  $\leq 2\%$ .
- ⑤  $C_{oss}$  eff. is a fixed capacitance that gives the same charging time as  $C_{oss}$  while  $V_{DS}$  is rising from 0 to 80%  $V_{DSS}$
- ⑥ Uses IRFIB5N65A data and test conditions

Data and specifications subject to change without notice.

International  
**IR** Rectifier

IR WORLD HEADQUARTERS: 233 Kansas St., El Segundo, California 90245, USA Tel: (310) 252-7105  
 TAC Fax: (310) 252-7903

Visit us at [www.irf.com](http://www.irf.com) for sales contact information. 06/04

[www.irf.com](http://www.irf.com)