

# International IR Rectifier

PD - 94973

## IRF610PbF

### HEXFET® Power MOSFET

- Dynamic  $dv/dt$  Rating
- Repetitive Avalanche Rated
- Fast Switching
- Ease of Paralleling
- Simple Drive Requirements
- Lead-Free

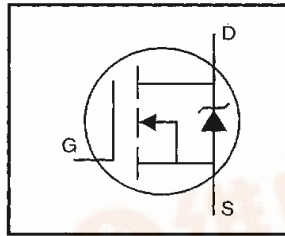

$$V_{DSS} = 200V$$

$$R_{DS(on)} = 1.5\Omega$$

$$I_D = 3.3A$$

### Description

Third Generation HEXFETs from International Rectifier provide the designer with the best combination of fast switching, ruggedized device design, low on-resistance and cost-effectiveness.

The TO-220 package is universally preferred for all commercial-industrial applications at power dissipation levels to approximately 50 watts. The low thermal resistance and low package cost of the TO-220 contribute to its wide acceptance throughout the industry.

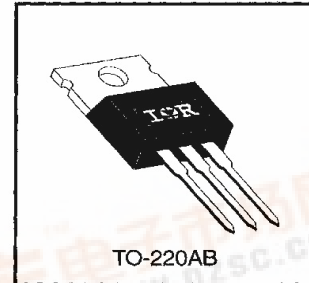

### Absolute Maximum Ratings

	Parameter	Max.	Units
$I_D @ T_C = 25^\circ C$	Continuous Drain Current, $V_{GS} @ 10 V$	3.3	A
$I_D @ T_C = 100^\circ C$	Continuous Drain Current, $V_{GS} @ 10 V$	2.1	
$I_{DM}$	Pulsed Drain Current ①	10	
$P_D @ T_C = 25^\circ C$	Power Dissipation	36	W
	Linear Derating Factor	0.29	W/°C
$V_{GS}$	Gate-to-Source Voltage	$\pm 20$	V
$E_{AS}$	Single Pulse Avalanche Energy ②	64	mJ
$I_{AR}$	Avalanche Current ①	3.3	A
$E_{AR}$	Repetitive Avalanche Energy ①	3.6	mJ
$dv/dt$	Peak Diode Recovery $dv/dt$ ③	5.0	V/ns
$T_J$ $T_{STG}$	Operating Junction and Storage Temperature Range	-55 to +150	°C
	Soldering Temperature, for 10 seconds	300 (1.6mm from case)	
	Mounting Torque, 6-32 or M3 screw	10 lbf•in (1.1 N•m)	

### Thermal Resistance

	Parameter	Min.	Typ.	Max.	Units
$R_{\theta JC}$	Junction-to-Case	—	—	3.5	°C/W
$R_{\theta CS}$	Case-to-Sink, Flat, Greased Surface	—	0.50	—	
$R_{\theta JA}$	Junction-to-Ambient	—	—	62	

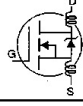

### Electrical Characteristics @ T<sub>J</sub> = 25°C (unless otherwise specified)

	Parameter	Min.	Typ.	Max.	Units	Test Conditions
V <sub>(BR)DSS</sub>	Drain-to-Source Breakdown Voltage	200	—	—	V	V <sub>GS</sub> =0V, I <sub>D</sub> = 250μA
ΔV <sub>(BR)DSS</sub> /ΔT <sub>J</sub>	Breakdown Voltage Temp. Coefficient	—	0.30	—	V/°C	Reference to 25°C, I <sub>D</sub> = 1mA
R <sub>DS(on)</sub>	Static Drain-to-Source On-Resistance	—	—	1.5	Ω	V <sub>GS</sub> =10V, I <sub>D</sub> =2.0A ④
V <sub>GS(th)</sub>	Gate Threshold Voltage	2.0	—	4.0	V	V <sub>DS</sub> =V <sub>GS</sub> , I <sub>D</sub> = 250μA
g <sub>fs</sub>	Forward Transconductance	0.80	—	—	S	V <sub>DS</sub> =50V, I <sub>D</sub> =2.0A ④
I <sub>DSS</sub>	Drain-to-Source Leakage Current	—	—	25	μA	V <sub>DS</sub> =200V, V <sub>GS</sub> =0V
		—	—	250		V <sub>DS</sub> =160V, V <sub>GS</sub> =0V, T <sub>J</sub> =125°C
I <sub>GSS</sub>	Gate-to-Source Forward Leakage	—	—	100	nA	V <sub>GS</sub> =20V
	Gate-to-Source Reverse Leakage	—	—	-100		V <sub>GS</sub> =-20V
Q <sub>g</sub>	Total Gate Charge	—	—	8.2	nC	I <sub>D</sub> =3.3A
Q <sub>gs</sub>	Gate-to-Source Charge	—	—	1.8		V <sub>DS</sub> =160V
Q <sub>gd</sub>	Gate-to-Drain ("Miller") Charge	—	—	4.5		V <sub>GS</sub> =10V See Fig. 6 and 13 ④
t <sub>d(on)</sub>	Turn-On Delay Time	—	8.2	—	ns	V <sub>DD</sub> =100V
t <sub>r</sub>	Rise Time	—	17	—		I <sub>D</sub> =3.3A
t <sub>d(off)</sub>	Turn-Off Delay Time	—	14	—		R <sub>G</sub> =24Ω
t <sub>f</sub>	Fall Time	—	8.9	—		R <sub>D</sub> =30Ω See Figure 10 ④
L <sub>D</sub>	Internal Drain Inductance	—	4.5	—	nH	Between lead, 6 mm (0.25in.) from package and center of die contact
L <sub>S</sub>	Internal Source Inductance	—	7.5	—		
C <sub>iss</sub>	Input Capacitance	—	140	—	pF	V <sub>GS</sub> =0V
C <sub>oss</sub>	Output Capacitance	—	53	—		V <sub>DS</sub> =25V
C <sub>rss</sub>	Reverse Transfer Capacitance	—	15	—		f=1.0MHz See Figure 5

### Source-Drain Ratings and Characteristics

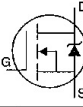
	Parameter	Min.	Typ.	Max.	Units	Test Conditions
I <sub>S</sub>	Continuous Source Current (Body Diode)	—	—	3.3	A	MOSFET symbol showing the integral reverse p-n junction diode.
I <sub>SM</sub>	Pulsed Source Current (Body Diode) ①	—	—	10		
V <sub>SD</sub>	Diode Forward Voltage	—	—	2.0	V	T <sub>J</sub> =25°C, I <sub>S</sub> =3.3A, V <sub>GS</sub> =0V ④
t <sub>rr</sub>	Reverse Recovery Time	—	150	310	ns	T <sub>J</sub> =25°C, I <sub>F</sub> =3.3A
Q <sub>rr</sub>	Reverse Recovery Charge	—	0.60	1.4	μC	di/dt=100A/μs ④
t <sub>on</sub>	Forward Turn-On Time	Intrinsic turn-on time is negligible (turn-on is dominated by L <sub>S</sub> +L <sub>D</sub> )				

#### Notes:

- ① Repetitive rating; pulse width limited by max. junction temperature (See Figure 11)
- ② V<sub>DD</sub>=50V, starting T<sub>J</sub>=25°C, L=8.8mH  
R<sub>G</sub>=25Ω, I<sub>AS</sub>=3.3A (See Figure 12)
- ③ I<sub>SD</sub>≤3.3A, di/dt≤70A/μs, V<sub>DD</sub>≤V<sub>(BR)DSS</sub>,  
T<sub>J</sub>≤150°C
- ④ Pulse width ≤ 300 μs; duty cycle ≤2%.

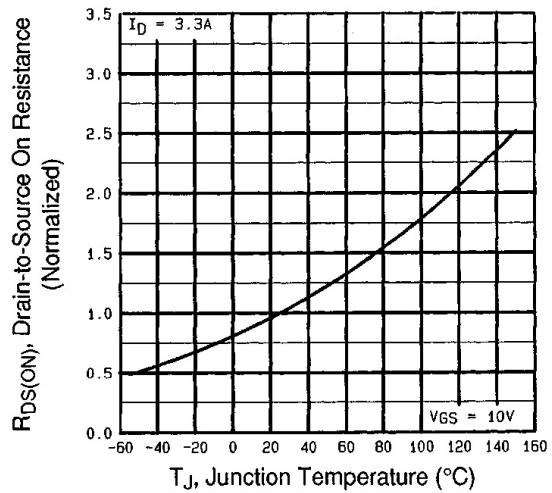
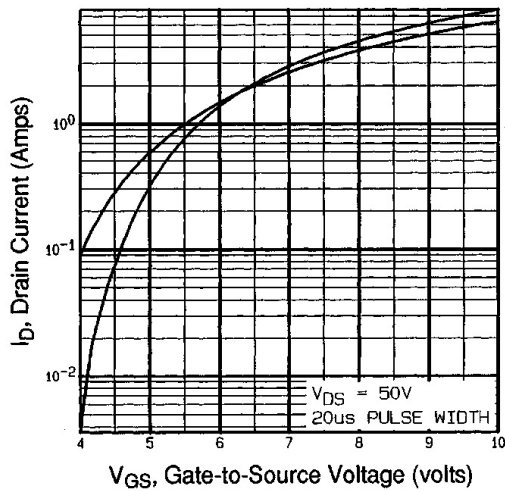
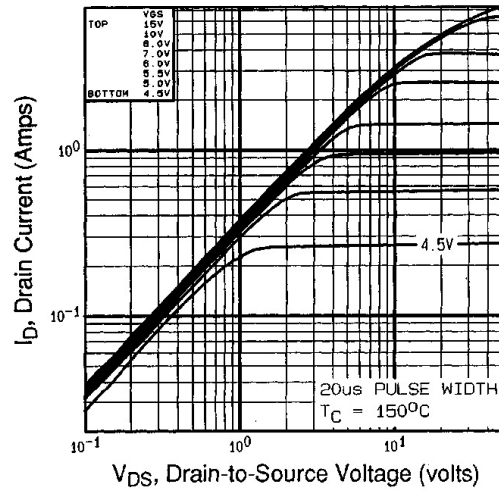
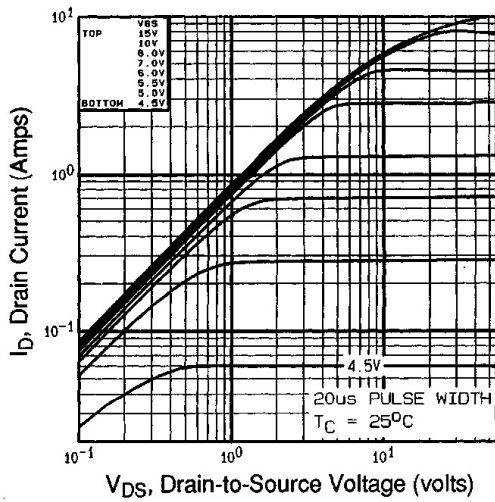

# IRF610PbF

International  
**IR** Rectifier

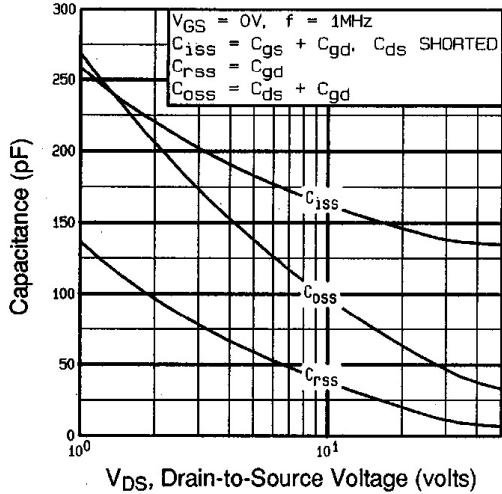

**Fig 5.** Typical Capacitance Vs. Drain-to-Source Voltage

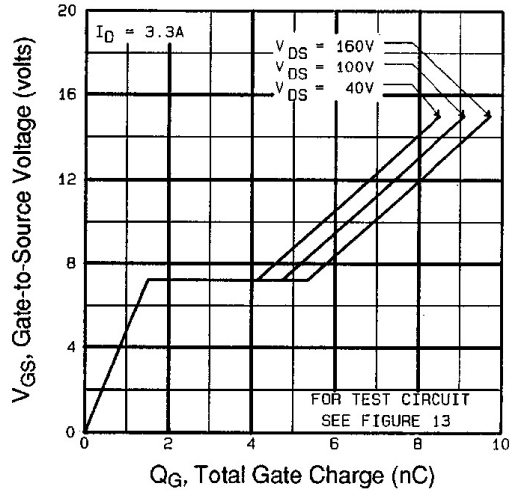

**Fig 6.** Typical Gate Charge Vs. Gate-to-Source Voltage

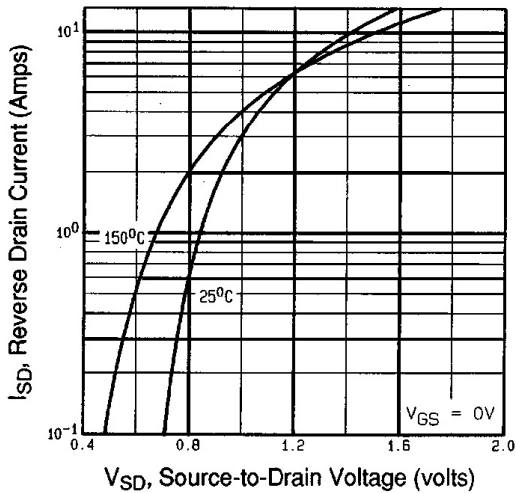

**Fig 7.** Typical Source-Drain Diode Forward Voltage

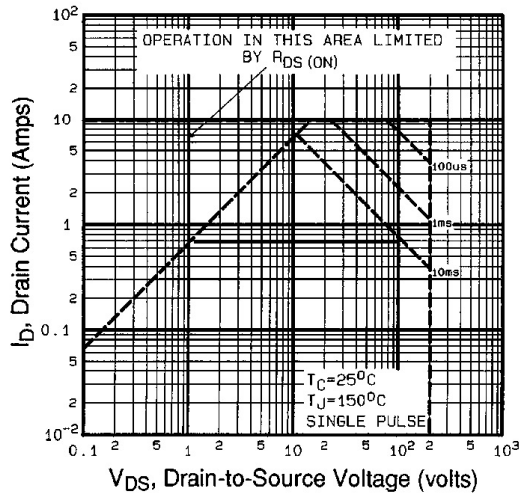

**Fig 8.** Maximum Safe Operating Area

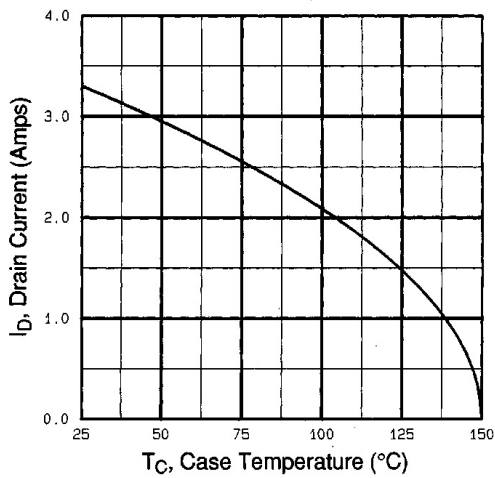

**Fig 9.** Maximum Drain Current Vs. Case Temperature

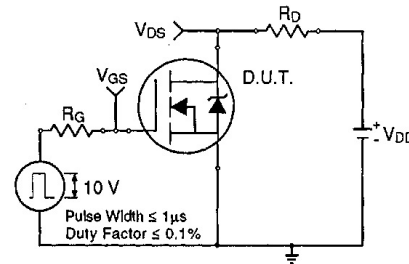

**Fig 10a.** Switching Time Test Circuit

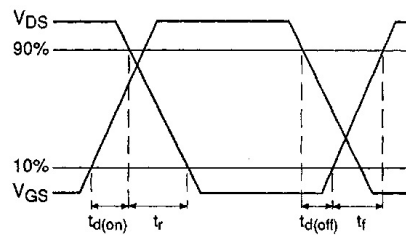

**Fig 10b.** Switching Time Waveforms

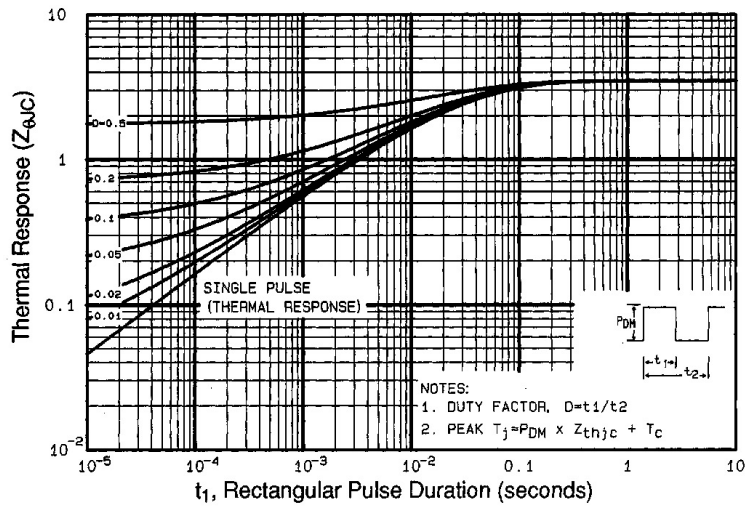

**Fig 11.** Maximum Effective Transient Thermal Impedance, Junction-to-Case

# IRF610PbF

International  
**IOR** Rectifier

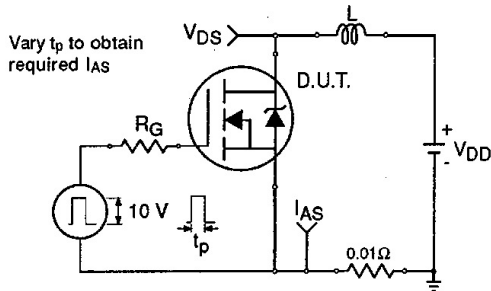

**Fig 12a.** Unclamped Inductive Test Circuit

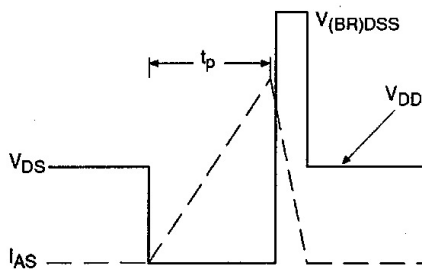

**Fig 12b.** Unclamped Inductive Waveforms

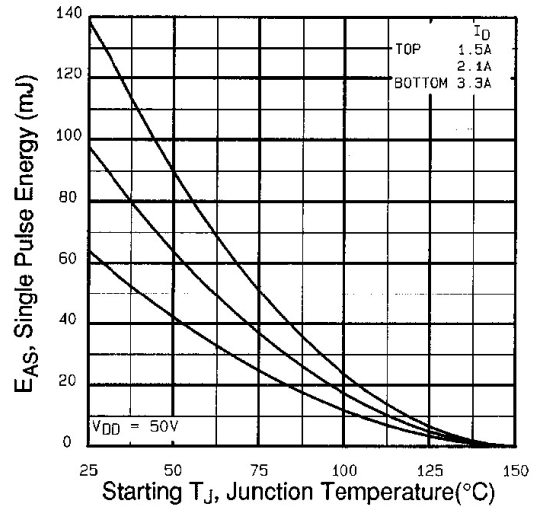

**Fig 12c.** Maximum Avalanche Energy Vs. Drain Current

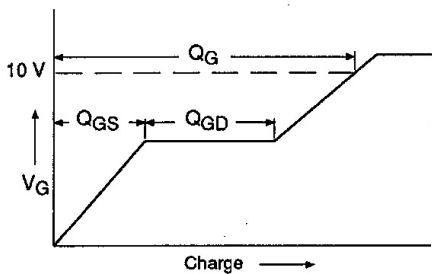

**Fig 13a.** Basic Gate Charge Waveform

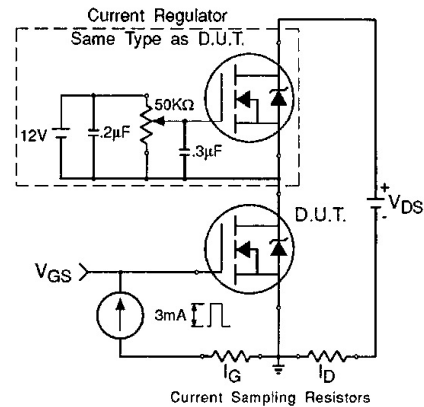

**Fig 13b.** Gate Charge Test Circuit

**Appendix A:** Figure 14, Peak Diode Recovery  $dv/dt$  Test Circuit – See page 1505

**Appendix B:** Package Outline Mechanical Drawing – See page 1509

**Appendix E:** Optional Leadforms – See page 1525

International  
**IOR** Rectifier

www.irf.com

## TO-220AB Package Outline

Dimensions are shown in millimeters (inches)

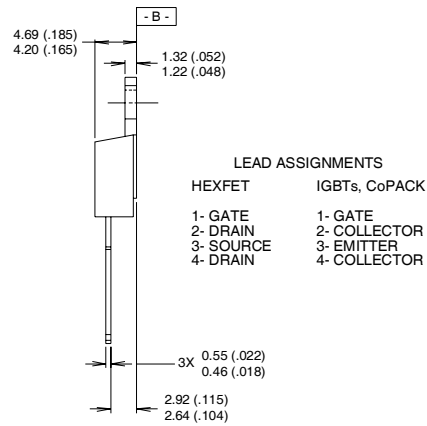
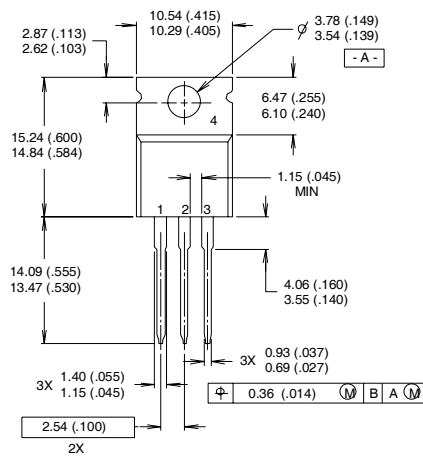

LEAD ASSIGNMENTS

HEXFET	IGBTs, CoPACK
1- GATE	1- GATE
2- DRAIN	2- COLLECTOR
3- SOURCE	3- EMITTER
4- DRAIN	4- COLLECTOR

NOTES:

- 1 DIMENSIONING & TOLERANCING PER ANSI Y14.5M, 1982.
- 2 CONTROLLING DIMENSION : INCH

- 3 OUTLINE CONFORMS TO JEDEC OUTLINE TO-220AB.
- 4 HEATSINK & LEAD MEASUREMENTS DO NOT INCLUDE BURRS.

## TO-220AB Part Marking Information

EXAMPLE: THIS IS AN IRF1010  
 LOT CODE 1789  
 ASSEMBLED ON WW 19, 1997  
 IN THE ASSEMBLY LINE "C"  
**Note:** "P" in assembly line  
 position indicates "Lead-Free"

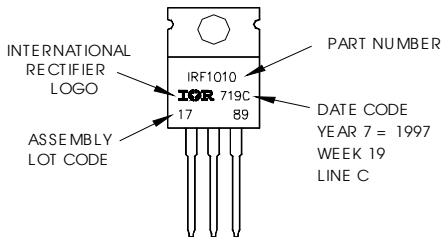

Data and specifications subject to change without notice.

International  
**IR** Rectifier

IR WORLD HEADQUARTERS: 233 Kansas St., El Segundo, California 90245, USA Tel: (310) 252-7105  
 TAC Fax: (310) 252-7903

Visit us at [www.irf.com](http://www.irf.com) for sales contact information.02/04