

International IR Rectifier

INSULATED GATE BIPOLAR TRANSISTOR WITH
HYPERFAST DIODE

Features

- Fast: optimized for medium operating frequencies (1-5 kHz in hard switching, >20kHz in resonant mode).
- Generation 4 IGBT design provides tighter parameter distribution and higher efficiency than Generation 3.
- IGBT co-packaged with Hyperfast FRED diodes for ultra low recovery characteristics.
- Industry standard TO-220AB package.
- Lead-Free

Benefits

- Generation 4 IGBT's offer highest efficiency available.
- IGBT's optimized for specific application conditions.
- FRED diodes optimized for performance with IGBT's. Minimized recovery characteristics require less / no snubbing.

PD - 95614
IRG4BC30FD1PbF
Fast CoPack IGBT

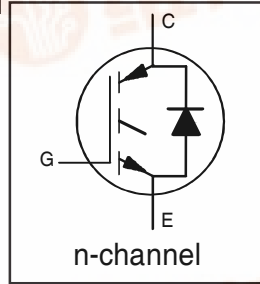

$V_{CES} = 600V$
$V_{CE(on) typ.} = 1.59V$
@ $V_{GE} = 15V, I_C = 17A$

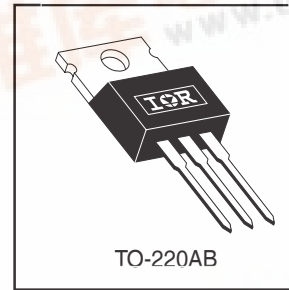

Absolute Maximum Ratings

	Parameter	Max.	Units
V_{CES}	Collector-to-Emitter Voltage	600	V
$I_C @ T_C = 25^\circ C$	Continuous Collector Current	31	A
$I_C @ T_C = 100^\circ C$	Continuous Collector Current	17	
I_{CM}	Pulse Collector Current (Ref.Fig.C.T.5) ①	120	
I_{LM}	Clamped Inductive Load current ②	120	
$I_F @ T_C = 100^\circ C$	Diode Continuous Forward Current	8	
I_{FM}	Diode Maximum Forward Current	16	
V_{GE}	Gate-to-Emitter Voltage	± 20	V
$P_D @ T_C = 25^\circ C$	Maximum Power Dissipation	100	W
$P_D @ T_C = 100^\circ C$	Maximum Power Dissipation	42	
T_J	Operating Junction and	-55 to +150	$^\circ C$
T_{STG}	Storage Temperature Range		
	Storage Temperature Range, for 10 sec.	300 (0.063 in. (1.6mm) from case)	
	Mounting Torque, 6-32 or M3 Screw	10 lbf-in (1.1 N-m)	

Thermal / Mechanical Characteristics

	Parameter	Min.	Typ.	Max.	Units
$R_{\theta JC}$	Junction-to-Case- IGBT	—	—	1.2	$^\circ C/W$
$R_{\theta JC}$	Junction-to-Case- Diode	—	—	2.0	
$R_{\theta CS}$	Case-to-Sink, flat, greased surface	—	0.50	—	
$R_{\theta JA}$	Junction-to-Ambient, typical socket mount	—	—	80	
Wt	Weight	—	2.0 (0.07)	—	g (oz.)



IRG4BC30FD1PbF

Electrical Characteristics @ $T_J = 25^\circ\text{C}$ (unless otherwise specified)

	Parameter	Min.	Typ.	Max.	Units	Conditions
$V_{(BR)CES}$	Collector-to-Emitter Breakdown Voltage ③	600	—	—	V	$V_{GE} = 0V, I_C = 250\mu A$
$\Delta V_{(BR)CES}/\Delta T_J$	Temperature Coeff. of Breakdown Voltage	—	0.69	—	V/°C	$V_{GE} = 0V, I_C = 1mA$
$V_{CE(on)}$	Collector-to-Emitter Voltage	—	1.59	1.8	V	$I_C = 17A, V_{GE} = 15V$ $I_C = 31A$ See Fig. 2, 5 $I_C = 17A, T_J = 150^\circ\text{C}$
		—	1.99	—		
		—	1.7	—		
$V_{GE(th)}$	Gate Threshold Voltage	3.0	—	6.0	V	$V_{CE} = V_{GE}, I_C = 250\mu A$
$\Delta V_{GE(th)}/\Delta T_J$	Threshold Voltage temp. coefficient	—	-11	—	mV/°C	$V_{CE} = V_{GE}, I_C = 250\mu A$
gfe	Forward Transconductance ④	6.1	10	—	S	$V_{CE} = 100V, I_C = 17A$
I_{CES}	Zero Gate Voltage Collector Current	—	—	250	μA	$V_{GE} = 0V, V_{CE} = 600V$
		—	—	2500		$V_{GE} = 0V, V_{CE} = 600V, T_J = 150^\circ\text{C}$
V_{FM}	Diode Forward Voltage Drop	—	2.0	2.4	V	$I_F = 8.0A$ See Fig. 13
		—	1.3	1.8		$I_F = 8.0A, T_J = 150^\circ\text{C}$
I_{GES}	Gate-to-Emitter Leakage Current	—	—	± 100	nA	$V_{GE} = \pm 20V$

Switching Characteristics @ $T_J = 25^\circ\text{C}$ (unless otherwise specified)

	Parameter	Min.	Typ.	Max.	Units	Conditions
Q_g	Total Gate Charge (turn-on)	—	57	62	nC	$I_C = 17A$ $V_{CC} = 400V$ See Fig. 8 $V_{GE} = 15V$
Q_{ge}	Gate-to-Emitter Charge (turn-on)	—	10	12		
Q_{gc}	Gate-to-Collector Charge (turn-on)	—	21	24		
$t_{d(on)}$	Turn-On delay time	—	22	—	ns	$T_J = 25^\circ\text{C}$ $I_C = 17A, V_{CC} = 480V$ $V_{GE} = 15V, R_G = 23\Omega$ Energy losses include "tail" and diode reverse recovery.
t_r	Rise time	—	24	—		
$t_{d(off)}$	Turn-Off delay time	—	250	320		
t_f	Fall time	—	160	210		
E_{on}	Turn-On Switching Loss	—	370	—	μJ	See Fig. 9, 10, 11, 18
E_{off}	Turn-Off Switching Loss	—	1420	—		
E_{ts}	Total Switching Loss	—	1800	2290		
$t_{d(on)}$	Turn-On delay time	—	21	—	ns	$T_J = 150^\circ\text{C}$ See Fig. 9,10,11,18 $I_C = 17A, V_{CC} = 480V$ $V_{GE} = 15V, R_G = 23\Omega$ Energy losses include "tail" and diode reverse recovery.
t_r	Rise time	—	25	—		
$t_{d(off)}$	Turn-Off delay time	—	400	—		
t_f	Fall time	—	340	—		
E_{ts}	Total Switching Loss	—	3280	—	μJ	
L_E	Internal Emitter Inductance	—	7.5	—	nH	Measured 5mm from package
C_{ies}	Input Capacitance	—	1170	—	pF	$V_{GE} = 0V$ $V_{CC} = 30V$ See Fig. 7 $f = 1.0MHz$
C_{oes}	Output Capacitance	—	100	—		
C_{res}	Reverse Transfer Capacitance	—	11	—		
t_{rr}	Diode Reverse Recovery Time	—	46	61	ns	$T_J = 25^\circ\text{C}$ See Fig. 14
		—	85	93		$T_J = 125^\circ\text{C}$
I_{rr}	Diode Peak Reverse Recovery Current	—	4.8	6.5	A	$T_J = 25^\circ\text{C}$ See Fig. 15
		—	8.5	10		$T_J = 125^\circ\text{C}$
Q_{rr}	Diode Reverse Recovery Charge	—	110	190	nC	$T_J = 25^\circ\text{C}$ See Fig. 16
		—	410	550		$T_J = 125^\circ\text{C}$
$di_{(rec)M}/dt$	Diode Peak Rate of Fall of Recovery During t_b	—	260	—	A/ μs	$T_J = 25^\circ\text{C}$ See Fig. 17
		—	270	—		$T_J = 125^\circ\text{C}$

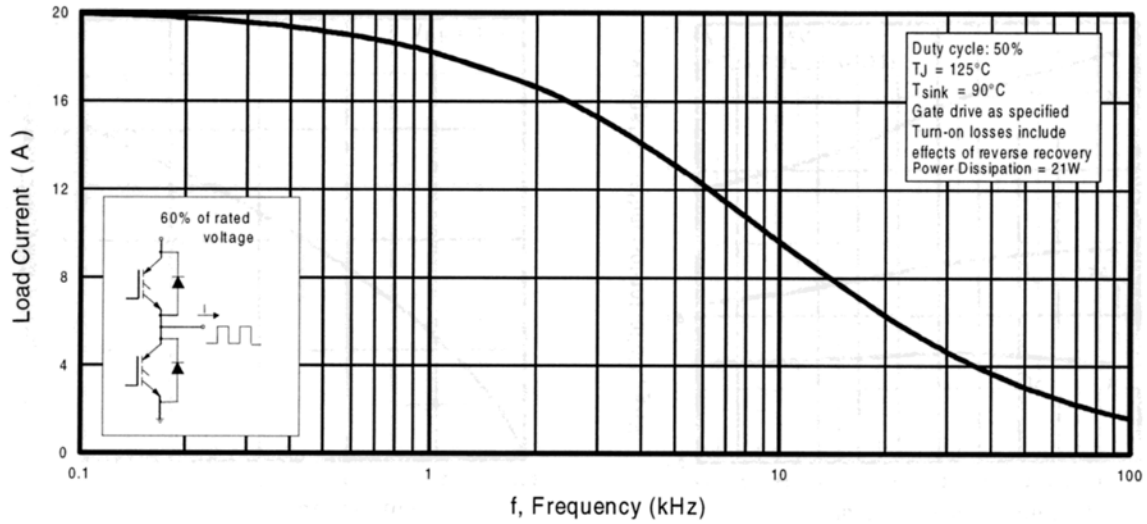

Fig. 1 - Typical Load Current vs. Frequency
 (For square wave, $I = I_{\text{RMS}}$ of fundamental; for triangular wave, $I = I_{\text{PK}}$)

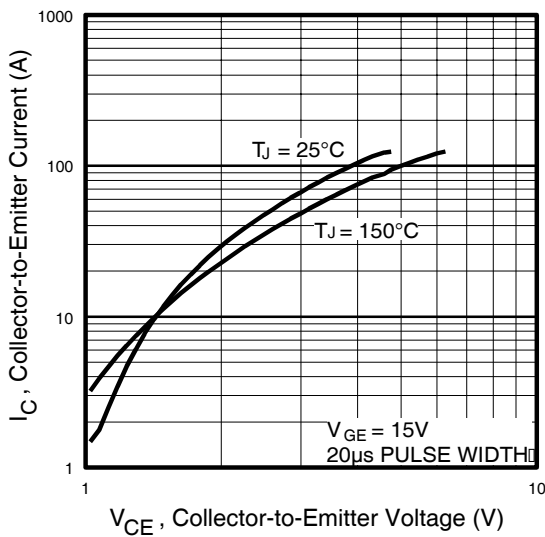

Fig. 2 - Typical Output Characteristics

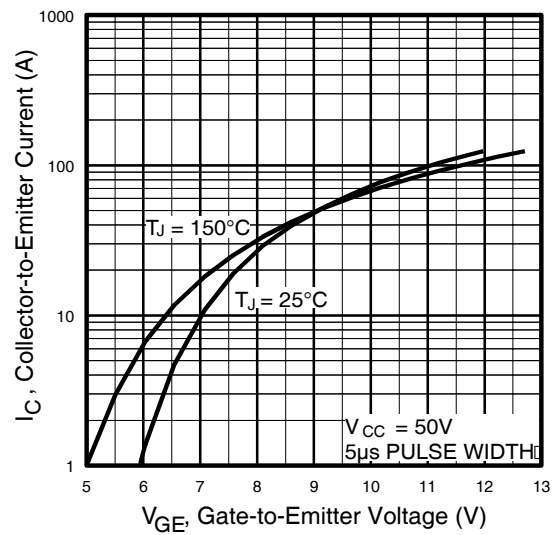

Fig. 3 - Typical Transfer Characteristics

IRG4BC30FD1PbF

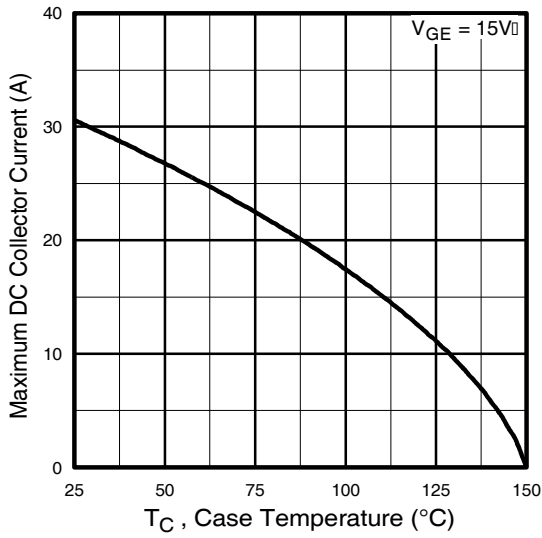

Fig. 4 - Maximum Collector Current vs. Case Temperature

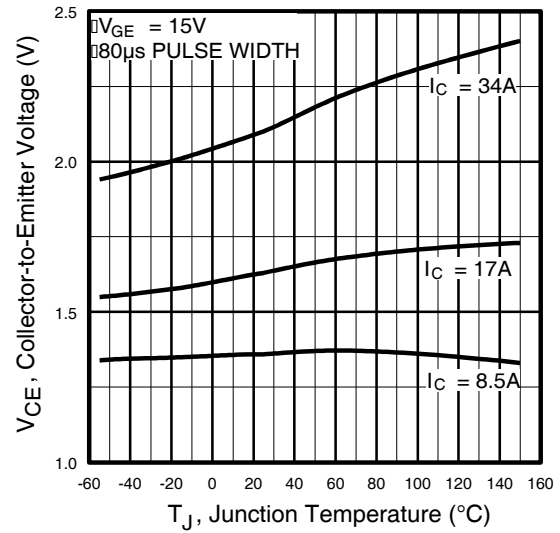

Fig. 5 - Typical Collector-to-Emitter Voltage vs. Junction Temperature

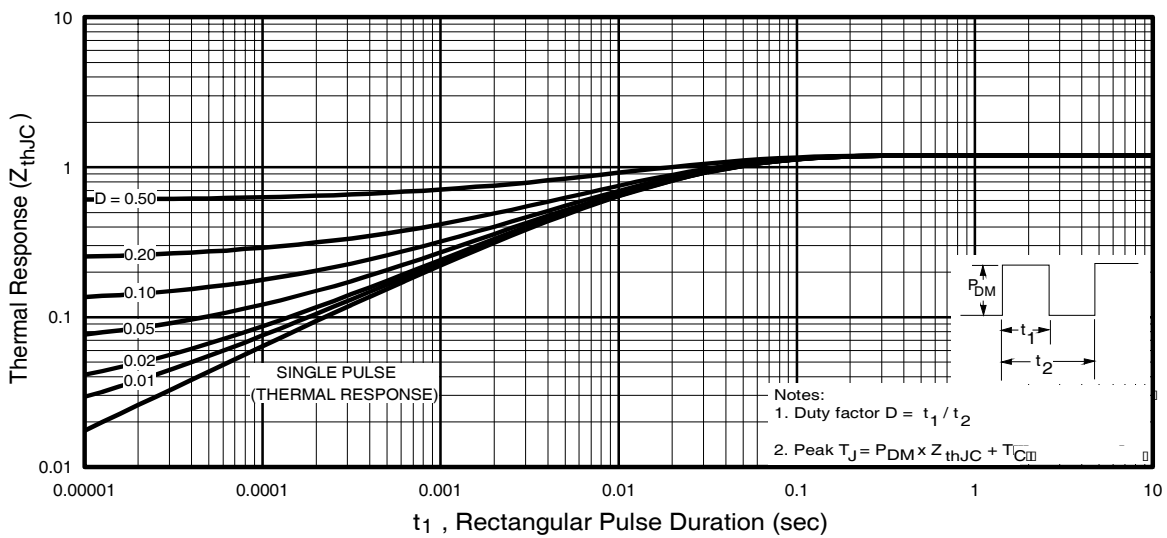

Fig. 6 - Maximum Effective Transient Thermal Impedance, Junction-to-Case

IRG4BC30FD1PbF

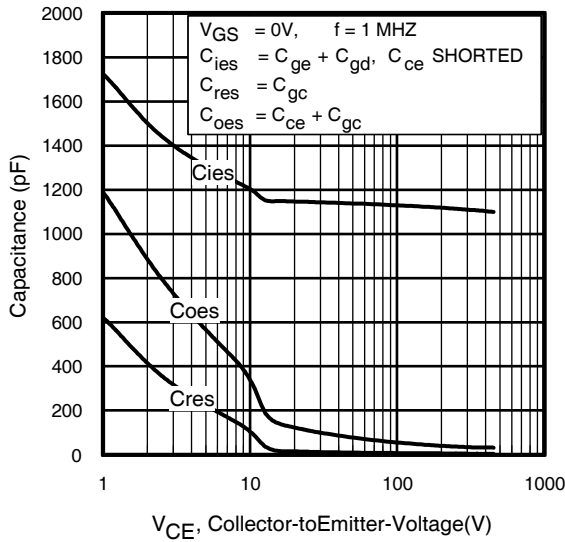

Fig. 7 - Typical Capacitance vs. Collector-to-Emitter Voltage

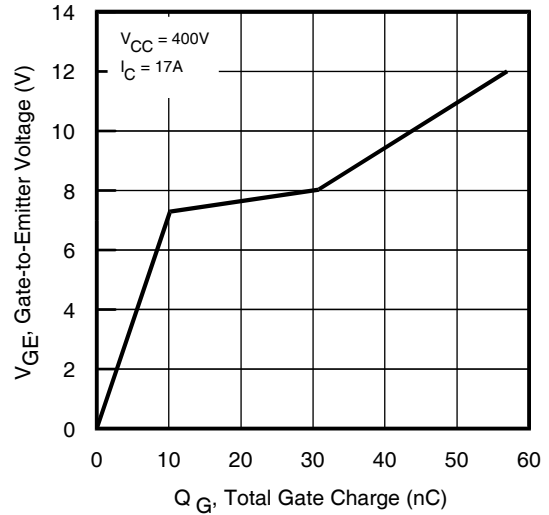

Fig. 8 - Typical Gate Charge vs. Gate-to-Emitter Voltage

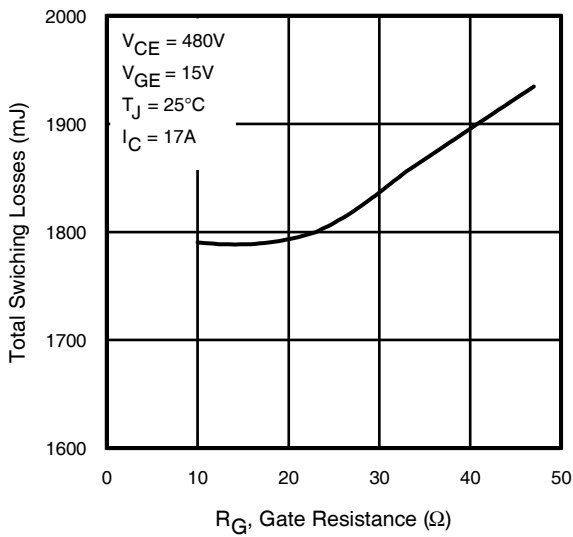

Fig. 9 - Typical Switching Losses vs. Gate Resistance

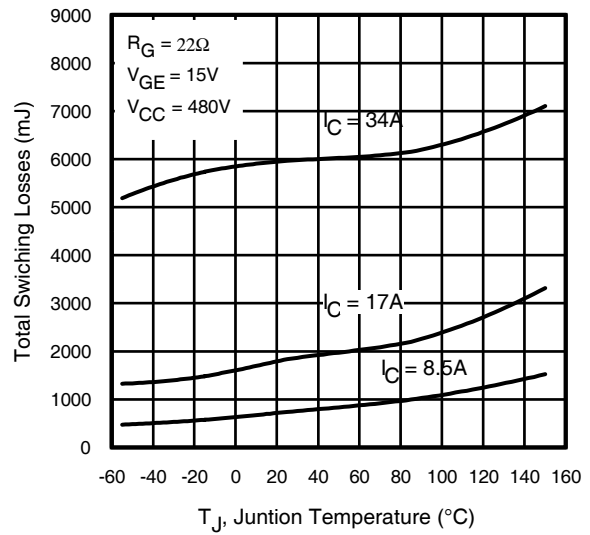

Fig. 10 - Typical Switching Losses vs. Junction Temperature

IRG4BC30FD1PbF

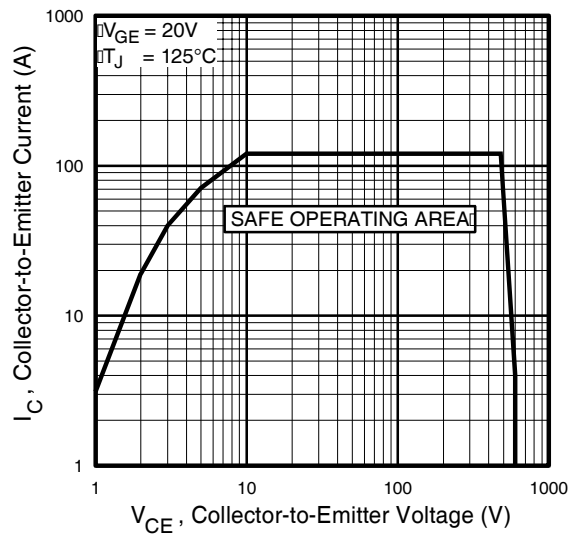
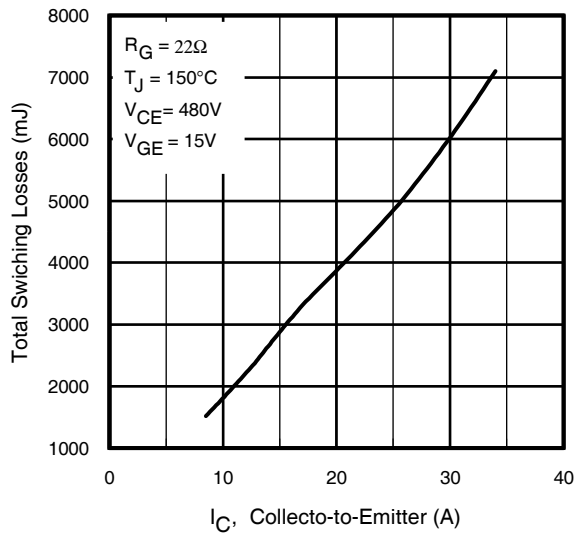

Fig. 11 - Typical Switching Losses vs. Collector-to-Emitter Current

Fig. 12 - Turn-Off SOA

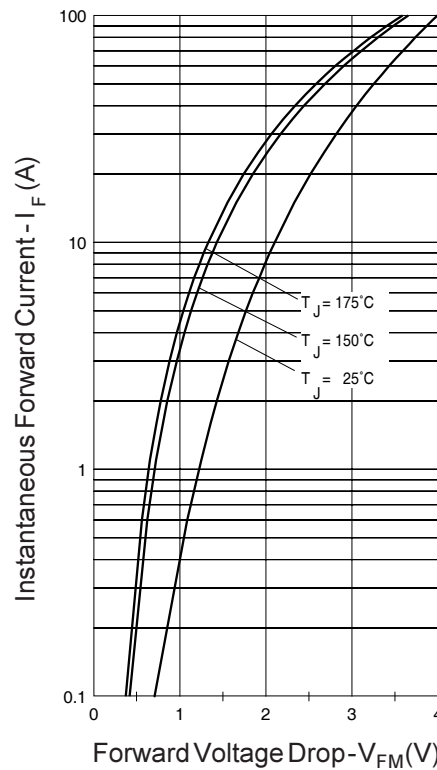

Fig. 13 - Maximum Forward Voltage Drop vs. Instantaneous Forward Current

IRG4BC30FD1PbF

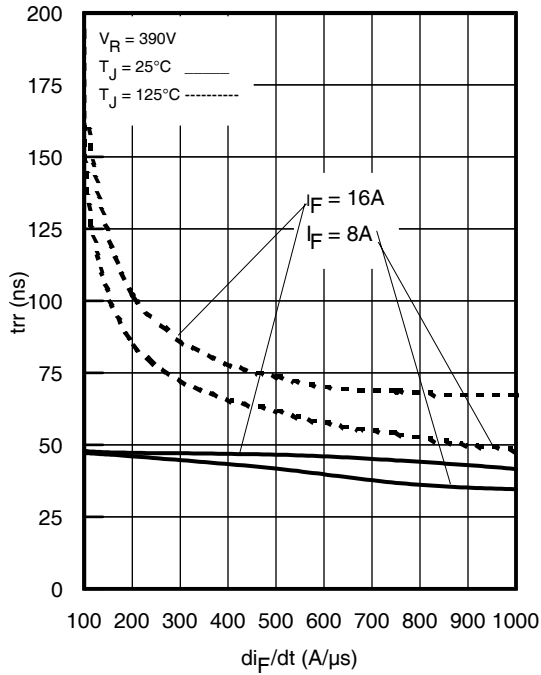

Fig. 14 - Typical Reverse Recovery vs. di_F/dt

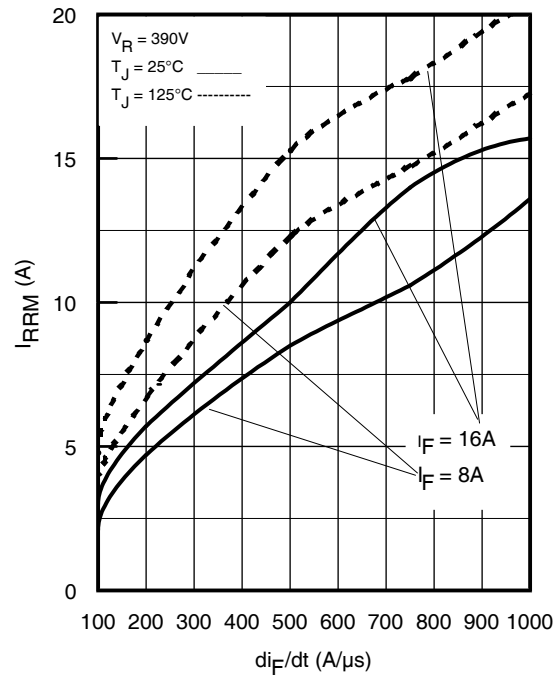

Fig. 15 - Typical Recovery Current vs. di_F/dt

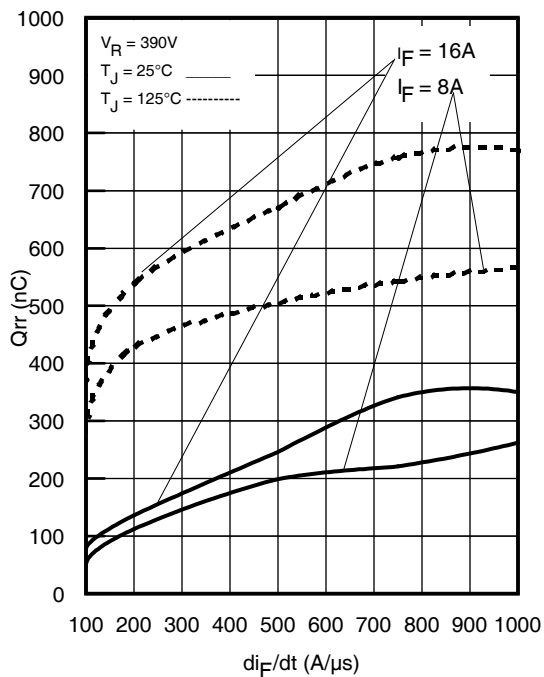

Fig. 16 - Typical Stored Charge vs. di_F/dt

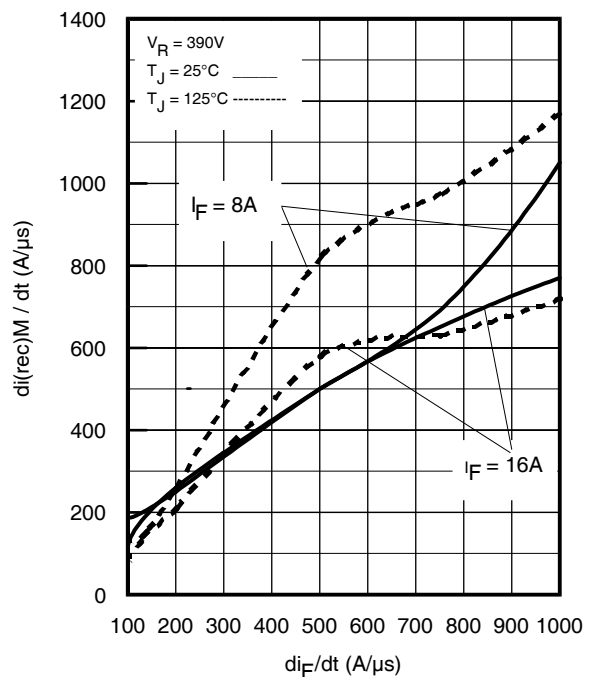

Fig. 17 - Typical $di_{(rec)M}/dt$ vs. di_F/dt

IRG4BC30FD1PbF

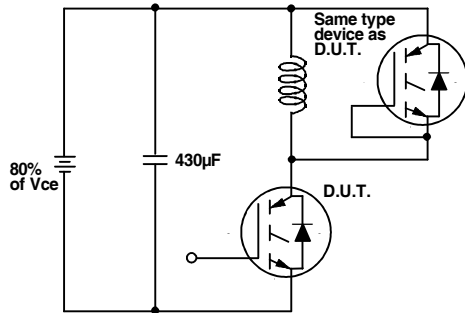

Fig. 18a - Test Circuit for Measurement of I_{LM} , E_{on} , $E_{off}(\text{diode})$, t_{rr} , Q_{rr} , I_{rr} , $t_{d(on)}$, t_r , $t_{d(off)}$, t_f

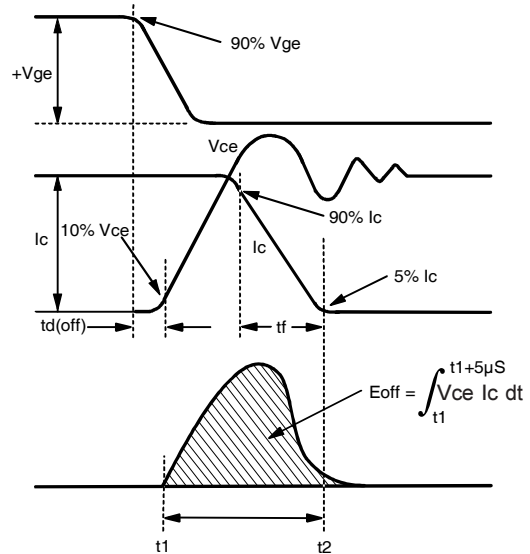

Fig. 18b - Test Waveforms for Circuit of Fig. 18a, Defining E_{off} , $t_{d(off)}$, t_f

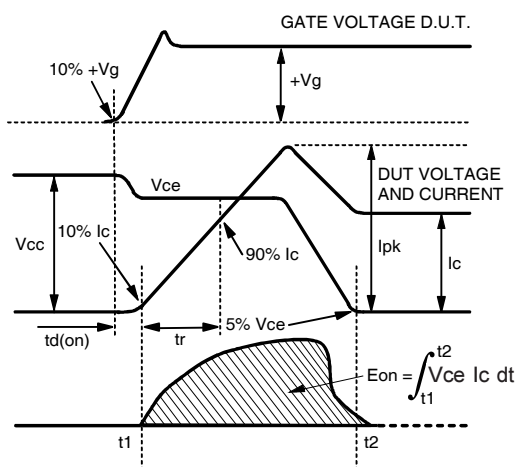

Fig. 18c - Test Waveforms for Circuit of Fig. 18a, Defining E_{on} , $t_{d(on)}$, t_r

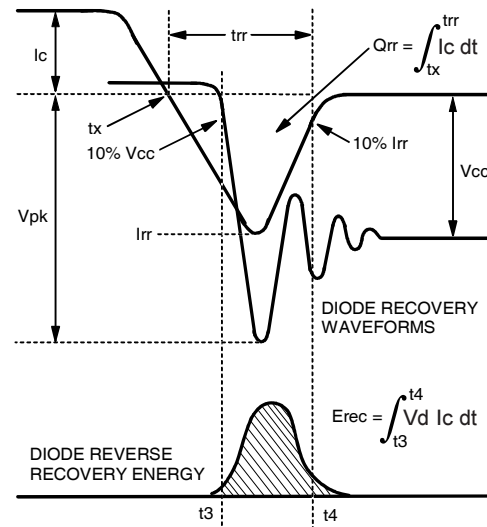

Fig. 18d - Test Waveforms for Circuit of Fig. 18a, Defining E_{rec} , t_{rr} , Q_{rr} , I_{rr}

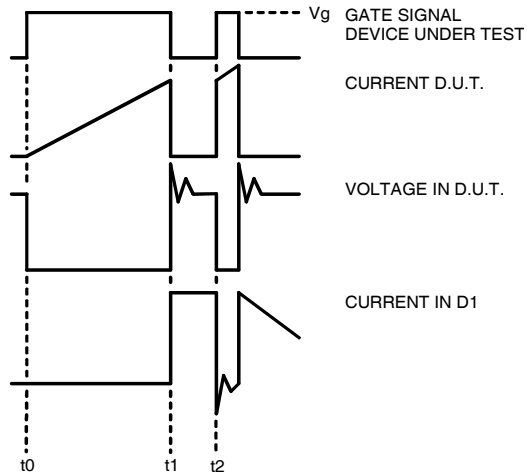

Fig.18e - Macro Waveforms for Figure 18a's Test Circuit

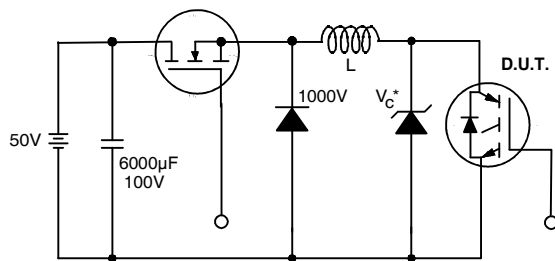

Fig. 19 - Clamped Inductive Load Test Circuit

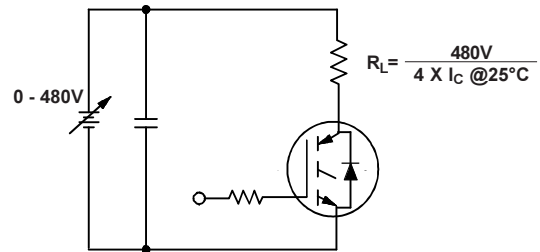
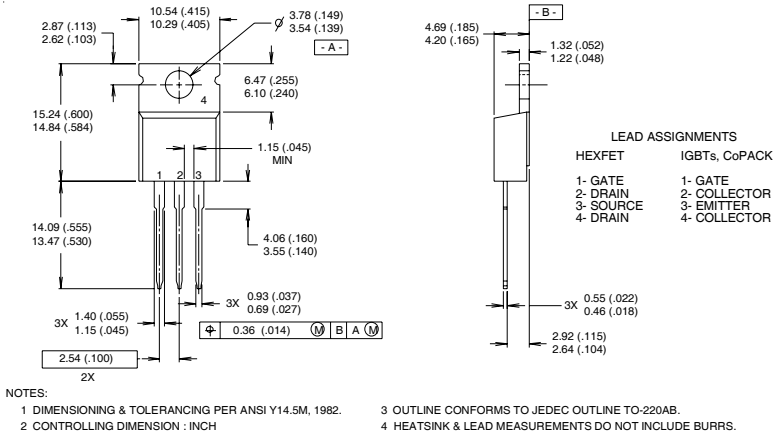

Fig. 20 - Pulsed Collector Current Test Circuit

IRG4BC30FD1PbF

TO-220AB Package Outline



TO-220AB Part Marking Information

EXAMPLE: THIS IS AN IRF1010
 LOT CODE 1789
 ASSEMBLED ON WW 19, 1997
 IN THE ASSEMBLY LINE "C"
Note: "P" in assembly line
 position indicates "Lead-Free"

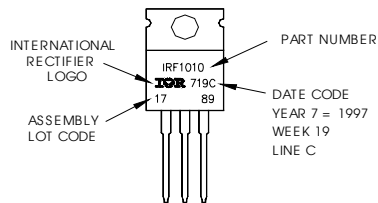

Notes:

- ① Repetitive rating: $V_{GE}=20V$; pulse width limited by maximum junction temperature (figure 20).
- ② $V_{CC}=80\%(V_{CES})$, $V_{GE}=20V$, $L=10\mu H$, $R_G = 23\Omega$ (figure 19).
- ③ Pulse width $\leq 80\mu s$; duty factor $\leq 0.1\%$.
- ④ Pulse width $5.0\mu s$, single shot.
- ⑤ Energy losses include "tail" and diode reverse recovery, using Diode FD100H06A5.

TO-220 package is not recommended for Surface Mount Application.

Data and specifications subject to change without notice.
 This product has been designed and qualified for the Industrial market.
 Qualification Standards can be found on IR's Web site.

Note: For the most current drawings please refer to the IR website at:
<http://www.irf.com/package/>