

International IR Rectifier

PD - 94923

IRG4PC30UPbF

INSULATED GATE BIPOLAR TRANSISTOR

UltraFast Speed IGBT

Features

- UltraFast: Optimized for high operating frequencies 8-40 kHz in hard switching, >200 kHz in resonant mode
- Generation 4 IGBT design provides tighter parameter distribution and higher efficiency than Generation 3
- Industry standard TO-247AC package
- Lead-Free

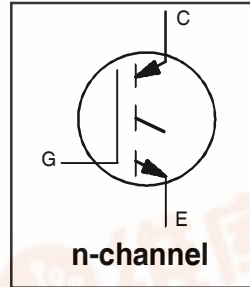

$V_{CES} = 600V$
$V_{CE(on)} \text{ typ.} = 1.95V$
@ $V_{GE} = 15V, I_C = 12A$

Benefits

- Generation 4 IGBT's offer highest efficiency available
- IGBT's optimized for specified application conditions
- Designed to be a "drop-in" replacement for equivalent industry-standard Generation 3 IR IGBT's

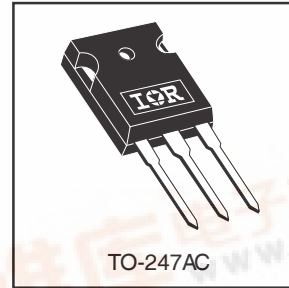

Absolute Maximum Ratings

	Parameter	Max.	Units
V_{CES}	Collector-to-Emitter Breakdown Voltage	600	V
$I_C @ T_C = 25^\circ C$	Continuous Collector Current	23	A
$I_C @ T_C = 100^\circ C$	Continuous Collector Current	12	
I_{CM}	Pulsed Collector Current ①	92	
I_{LM}	Clamped Inductive Load Current ②	92	
V_{GE}	Gate-to-Emitter Voltage	± 20	V
E_{ARV}	Reverse Voltage Avalanche Energy ③	10	mJ
$P_D @ T_C = 25^\circ C$	Maximum Power Dissipation	100	W
$P_D @ T_C = 100^\circ C$	Maximum Power Dissipation	42	
T_J	Operating Junction and Storage Temperature Range	-55 to + 150	$^\circ C$
T_{STG}			
	Soldering Temperature, for 10 seconds	300 (0.063 in. (1.6mm from case)	
	Mounting torque, 6-32 or M3 screw.	10 lbf·in (1.1N·m)	

Thermal Resistance

	Parameter	Typ.	Max.	Units
$R_{\theta JC}$	Junction-to-Case	---	1.2	$^\circ C/W$
$R_{\theta CS}$	Case-to-Sink, Flat, Greased Surface	0.24	---	
$R_{\theta JA}$	Junction-to-Ambient, typical socket mount	---	40	
Wt	Weight	6 (0.21)	---	g (oz)



Electrical Characteristics @ T_J = 25°C (unless otherwise specified)

	Parameter	Min.	Typ.	Max.	Units	Conditions
V _{(BR)CES}	Collector-to-Emitter Breakdown Voltage	600	—	—	V	V _{GE} = 0V, I _C = 250μA
V _{(BR)ECS}	Emitter-to-Collector Breakdown Voltage ④	18	—	—	V	V _{GE} = 0V, I _C = 1.0A
ΔV _{(BR)CES} /ΔT _J	Temperature Coeff. of Breakdown Voltage	—	0.63	—	V/°C	V _{GE} = 0V, I _C = 1.0mA
V _{CE(ON)}	Collector-to-Emitter Saturation Voltage	—	1.95	2.1	V	I _C = 12A, V _{GE} = 15V
		—	2.52	—		I _C = 23A
		—	2.09	—		I _C = 12A, T _J = 150°C
V _{GE(th)}	Gate Threshold Voltage	3.0	—	6.0		V _{CE} = V _{GE} , I _C = 250μA
ΔV _{GE(th)} /ΔT _J	Temperature Coeff. of Threshold Voltage	—	-13	—	mV/°C	V _{CE} = V _{GE} , I _C = 250μA
g _{fe}	Forward Transconductance ⑤	3.1	8.6	—	S	V _{CE} = 100 V, I _C = 12A
I _{CES}	Zero Gate Voltage Collector Current	—	—	250	μA	V _{GE} = 0V, V _{CE} = 600V
		—	—	2.0		V _{GE} = 0V, V _{CE} = 10V, T _J = 25°C
		—	—	1000		V _{GE} = 0V, V _{CE} = 600V, T _J = 150°C
I _{GES}	Gate-to-Emitter Leakage Current	—	—	±100	nA	V _{GE} = ±20V

Switching Characteristics @ T_J = 25°C (unless otherwise specified)

	Parameter	Min.	Typ.	Max.	Units	Conditions
Q _g	Total Gate Charge (turn-on)	—	50	75	nC	I _C = 12A
Q _{ge}	Gate - Emitter Charge (turn-on)	—	8.1	12		V _{CC} = 400V
Q _{gc}	Gate - Collector Charge (turn-on)	—	18	27		V _{GE} = 15V
t _{d(on)}	Turn-On Delay Time	—	17	—	ns	T _J = 25°C
t _r	Rise Time	—	9.6	—		I _C = 12A, V _{CC} = 480V
t _{d(off)}	Turn-Off Delay Time	—	78	120		V _{GE} = 15V, R _G = 23Ω
t _f	Fall Time	—	97	150		Energy losses include "tail"
E _{on}	Turn-On Switching Loss	—	0.16	—	mJ	See Fig. 10, 11, 13, 14
E _{off}	Turn-Off Switching Loss	—	0.20	—		
E _{ts}	Total Switching Loss	—	0.36	0.50		
t _{d(on)}	Turn-On Delay Time	—	20	—	ns	T _J = 150°C,
t _r	Rise Time	—	13	—		I _C = 12A, V _{CC} = 480V
t _{d(off)}	Turn-Off Delay Time	—	180	—		V _{GE} = 15V, R _G = 23Ω
t _f	Fall Time	—	140	—		Energy losses include "tail"
E _{ts}	Total Switching Loss	—	0.73	—	mJ	See Fig. 13, 14
L _E	Internal Emitter Inductance	—	13	—	nH	Measured 5mm from package
C _{ies}	Input Capacitance	—	1100	—	pF	V _{GE} = 0V
C _{oes}	Output Capacitance	—	73	—		V _{CC} = 30V
C _{res}	Reverse Transfer Capacitance	—	14	—		f = 1.0MHz

Notes:

- ① Repetitive rating; V_{GE} = 20V, pulse width limited by max. junction temperature. (See fig. 13b)
- ② V_{CC} = 80%(V_{CES}), V_{GE} = 20V, L = 10μH, R_G = 23Ω, (See fig. 13a)
- ③ Repetitive rating; pulse width limited by maximum junction temperature.
- ④ Pulse width ≤ 80μs; duty factor ≤ 0.1%.
- ⑤ Pulse width 5.0μs, single shot.

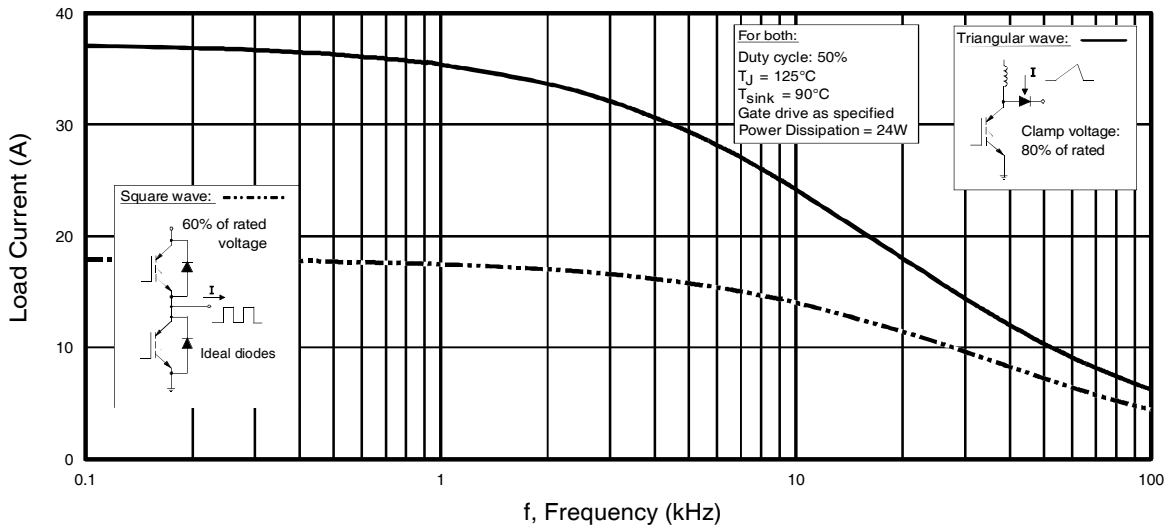

Fig. 1 - Typical Load Current vs. Frequency
(For square wave, $I = I_{RMS}$ of fundamental; for triangular wave, $I = I_{PK}$)

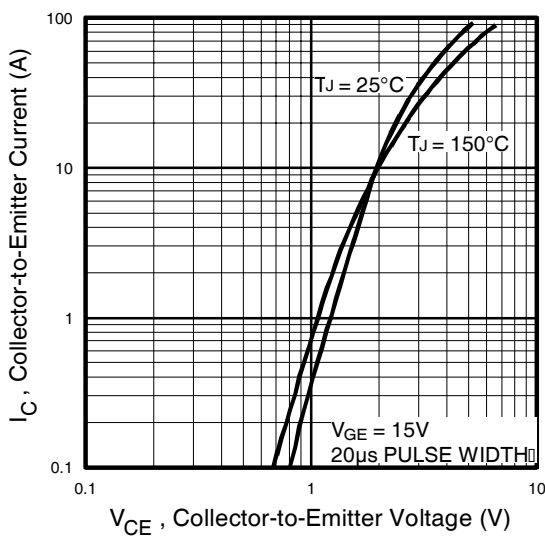

Fig. 2 - Typical Output Characteristics

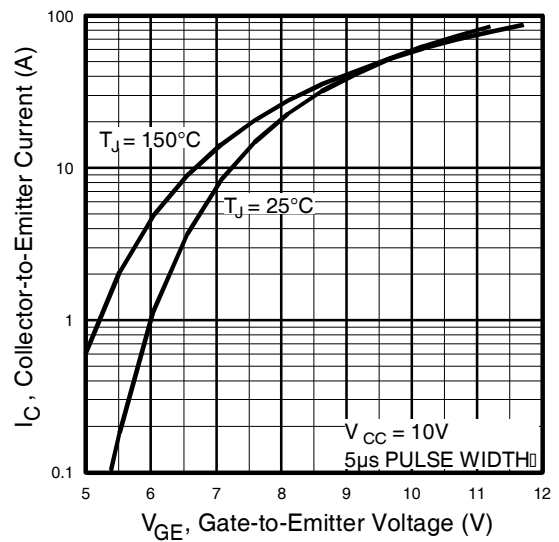

Fig. 3 - Typical Transfer Characteristics

IRG4PC30UPbF

International
IR Rectifier

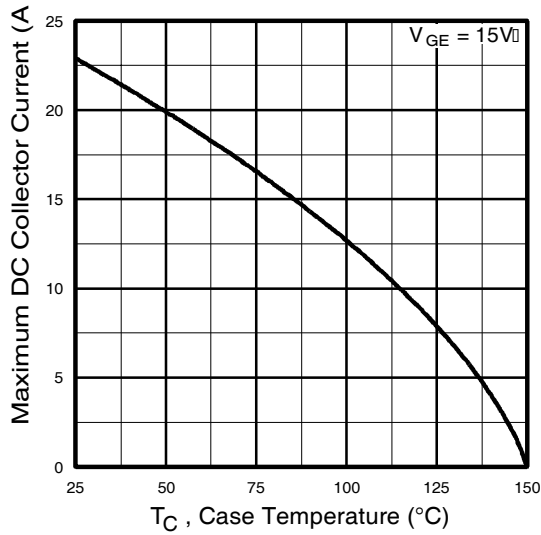

Fig. 4 - Maximum Collector Current vs. Case Temperature

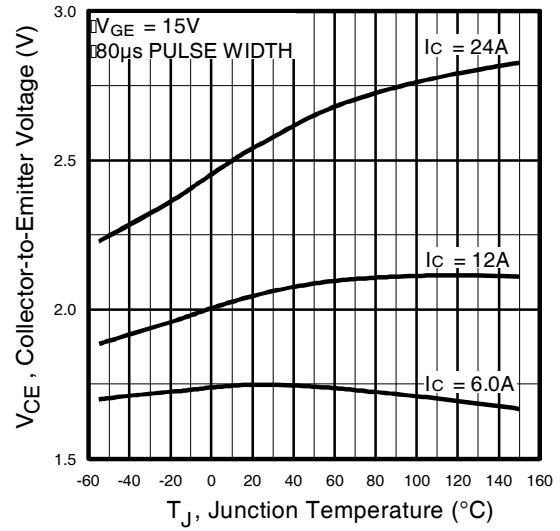

Fig. 5 - Collector-to-Emitter Voltage vs. Junction Temperature

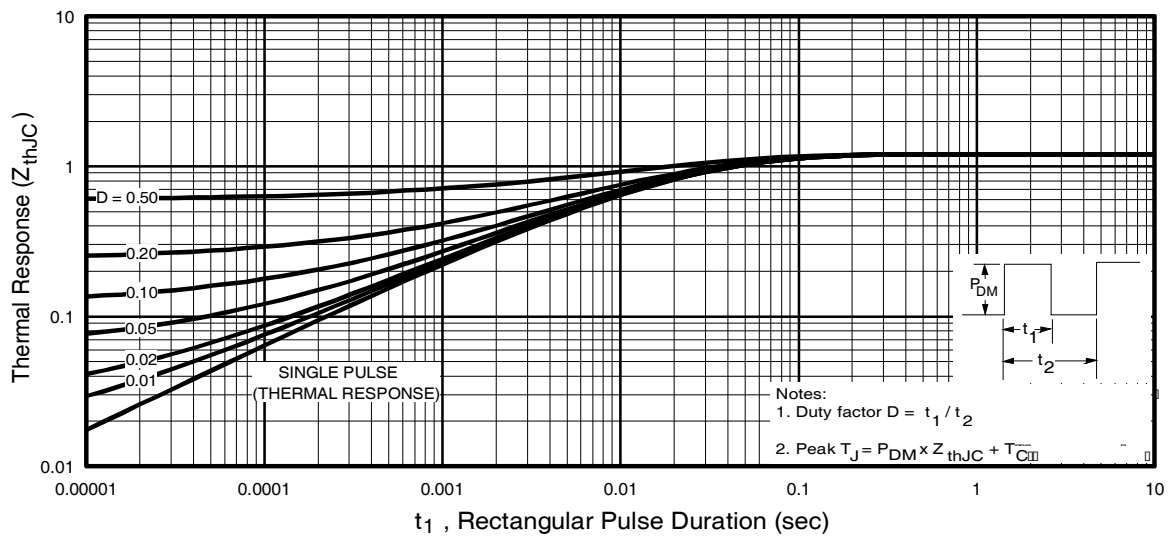

Fig. 6 - Maximum Effective Transient Thermal Impedance, Junction-to-Case

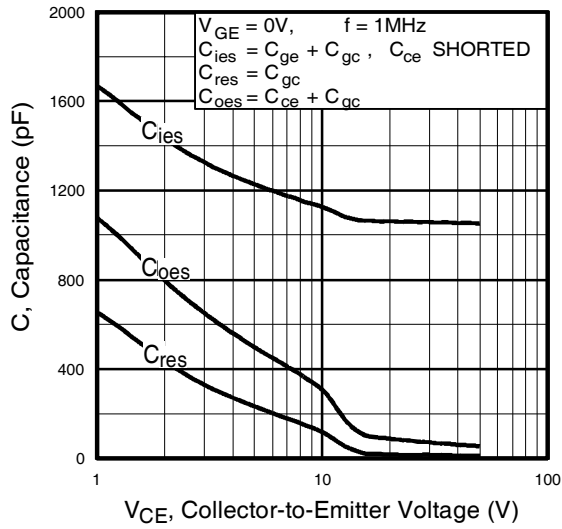

Fig. 7 - Typical Capacitance vs. Collector-to-Emitter Voltage

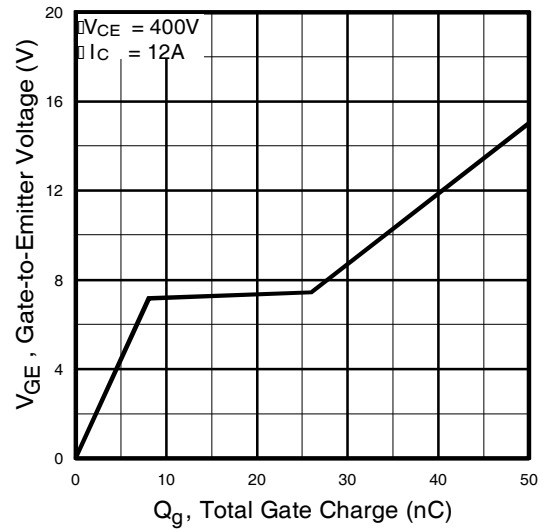

Fig. 8 - Typical Gate Charge vs. Gate-to-Emitter Voltage

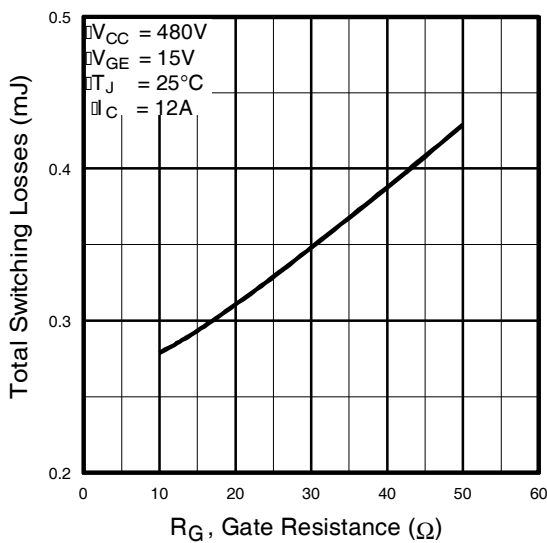

Fig. 9 - Typical Switching Losses vs. Gate Resistance

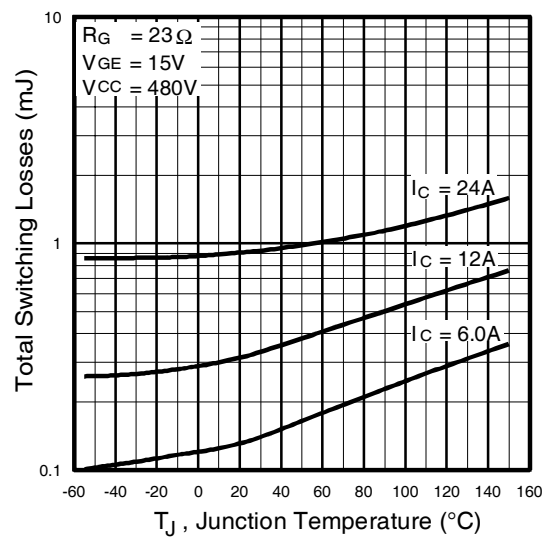

Fig. 10 - Typical Switching Losses vs. Junction Temperature

IRG4PC30UPbF

International
IR Rectifier

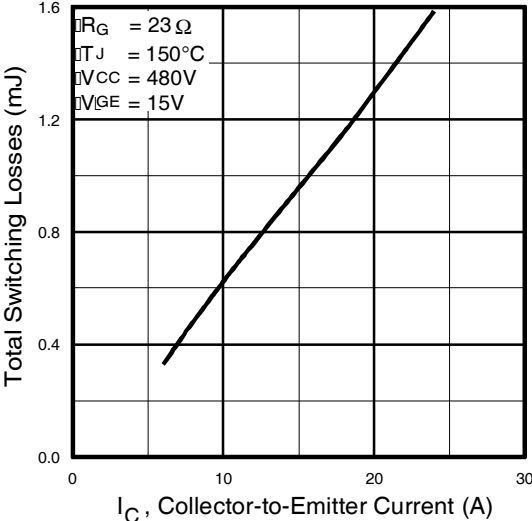

Fig. 11 - Typical Switching Losses vs. Collector-to-Emitter Current

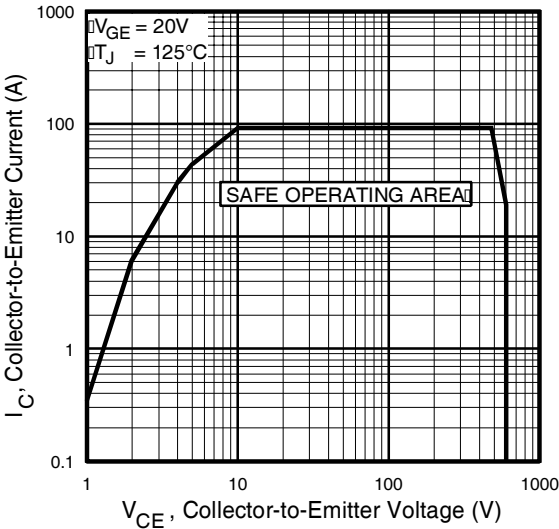

Fig. 12 - Turn-Off SOA

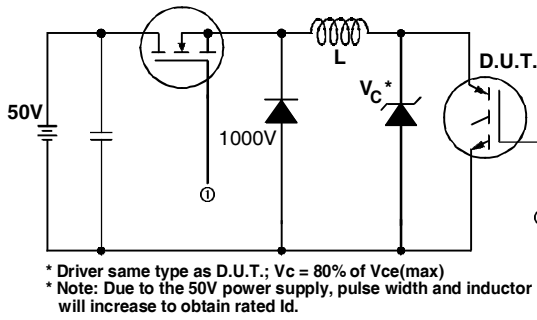

Fig. 13a - Clamped Inductive Load Test Circuit

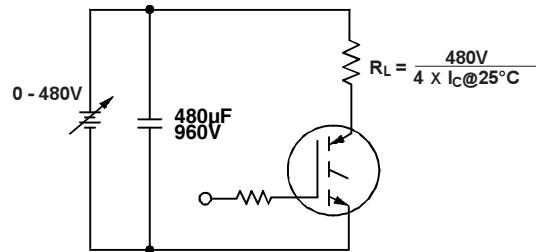

Fig. 13b - Pulsed Collector Current Test Circuit

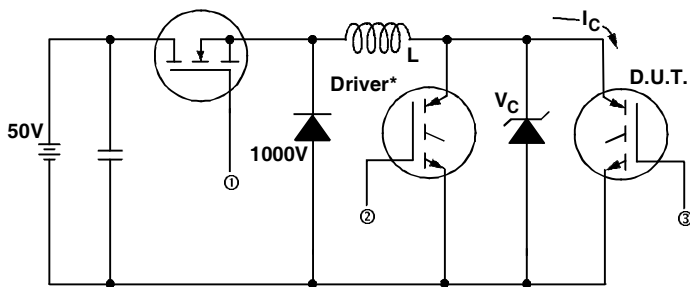

Fig. 14a - Switching Loss Test Circuit

* Driver same type as D.U.T., $V_C = 480V$

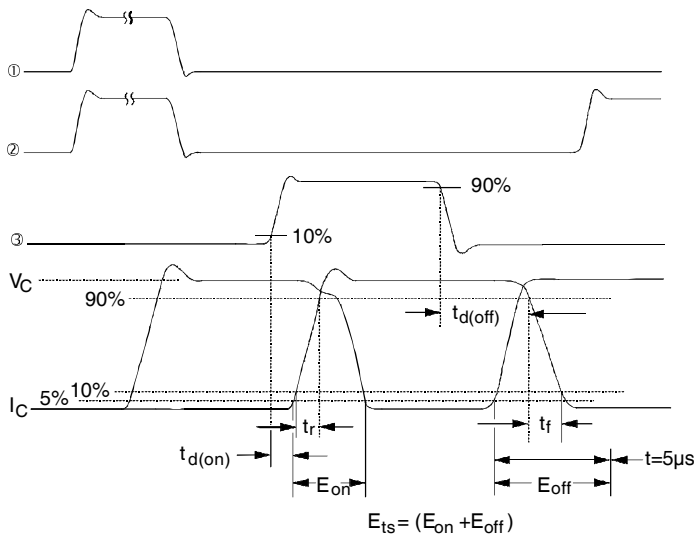

Fig. 14b - Switching Loss Waveforms

IRG4PC30UPbF

International
IR Rectifier

TO-247AC Package Outline

Dimensions are shown in millimeters (inches)

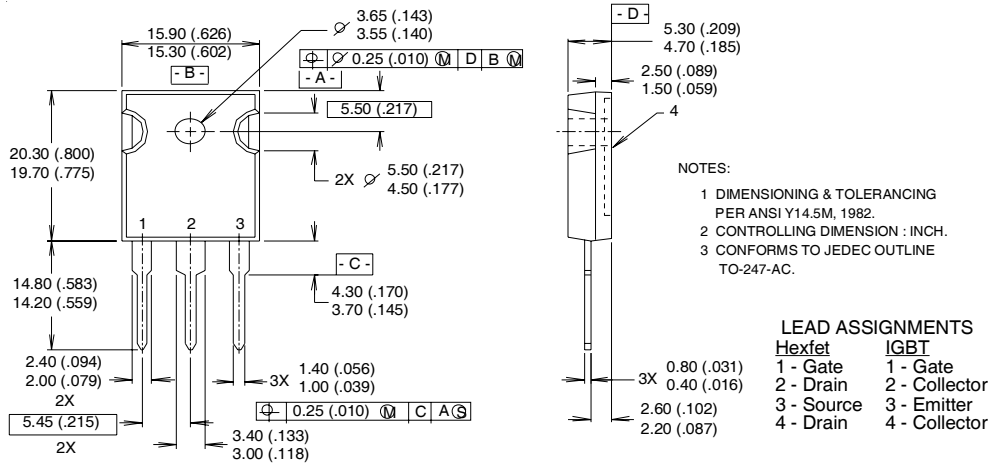

TO-247AC Part Marking Information

EXAMPLE: THIS IS AN IRFPE30
WITH ASSEMBLY
LOT CODE 5657
ASSEMBLED ON WW 35, 2000
IN THE ASSEMBLY LINE "H"

Note: "P" in assembly line position indicates "Lead-Free"

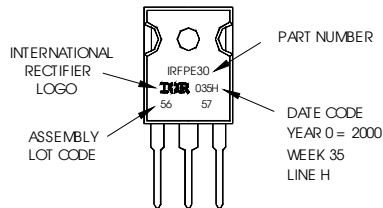

Data and specifications subject to change without notice.

International
IR Rectifier

IR WORLD HEADQUARTERS: 233 Kansas St., El Segundo, California 90245, USA Tel: (310) 252-7105
TAC Fax: (310) 252-7903

Visit us at www.irf.com for sales contact information.12/03

Note: For the most current drawings please refer to the IR website at:
<http://www.irf.com/package/>