

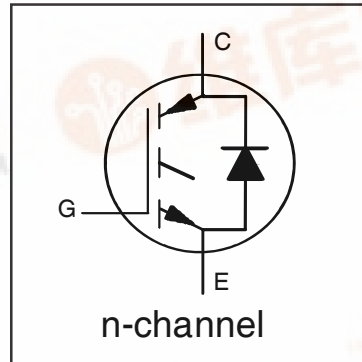
# International IOR Rectifier

# IRGB4061DPbF

## INSULATED GATE BIPOLAR TRANSISTOR WITH ULTRAFAST SOFT RECOVERY DIODE

### Features

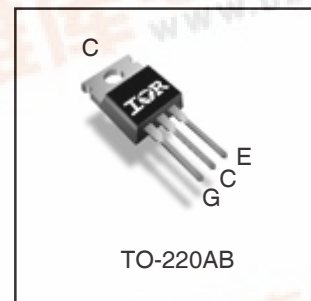
- Low  $V_{CE(ON)}$  Trench IGBT Technology
- Low switching losses
- Maximum Junction temperature 175 °C
- 5  $\mu$ S short circuit SOA
- Square RBSOA
- 100% of the parts tested for 4X rated current ( $I_{LM}$ )
- Positive  $V_{CE(ON)}$  Temperature co-efficient
- Ultra fast soft Recovery Co-Pak Diode
- Tight parameter distribution
- Lead Free Package



$V_{CES} = 600V$
$I_C = 18A, T_C = 100^\circ C$
$t_{SC} \geq 5\mu s, T_{J(max)} = 175^\circ C$
$V_{CE(on)} \text{ typ.} = 1.65V$

### Benefits

- High Efficiency in a wide range of applications
- Suitable for a wide range of switching frequencies due to Low  $V_{CE(ON)}$  and Low Switching losses
- Rugged transient Performance for increased reliability
- Excellent Current sharing in parallel operation
- Low EMI



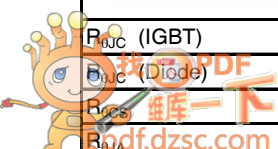
<b>G</b>	<b>C</b>	<b>E</b>
Gate	Collector	Emitter

### Absolute Maximum Ratings

	Parameter	Max.	Units
$V_{CES}$	Collector-to-Emitter Voltage	600	V
$I_C @ T_C = 25^\circ C$	Continuous Collector Current	36	A
$I_C @ T_C = 100^\circ C$	Continuous Collector Current	18	
$I_{CM}$	Pulse Collector Current	72	
$I_{LM}$	Clamped Inductive Load Current <sup>①</sup>	72	
$I_F @ T_C = 25^\circ C$	Diode Continuous Forward Current	36	
$I_F @ T_C = 100^\circ C$	Diode Continuous Forward Current	18	
$I_{FM}$	Diode Maximum Forward Current <sup>③</sup>	72	V
$V_{GE}$	Continuous Gate-to-Emitter Voltage	$\pm 20$	
	Transient Gate-to-Emitter Voltage	$\pm 30$	
$P_D @ T_C = 25^\circ C$	Maximum Power Dissipation	206	W
$P_D @ T_C = 100^\circ C$	Maximum Power Dissipation	103	
$T_J$	Operating Junction and	-55 to +175	°C
$T_{STG}$	Storage Temperature Range		
	Soldering Temperature, for 10 sec.	300 (0.063 in. (1.6mm) from case)	
	Mounting Torque, 6-32 or M3 Screw	10 lbf-in (1.1 N·m)	

### Thermal Resistance

	Parameter	Min.	Typ.	Max.	Units
$R_{\theta JC}$ (IGBT)	Thermal Resistance Junction-to-Case-(each IGBT)	—	—	0.73	°C/W
$R_{\theta JC}$ (Diode)	Thermal Resistance Junction-to-Case-(each Diode)	—	—	2.00	
$R_{\theta CS}$	Thermal Resistance, Case-to-Sink (flat, greased surface)	—	0.50	—	
$R_{\theta JA}$	Thermal Resistance, Junction-to-Ambient (typical socket mount)	—	80	—	



## Electrical Characteristics @ T<sub>J</sub> = 25°C (unless otherwise specified)

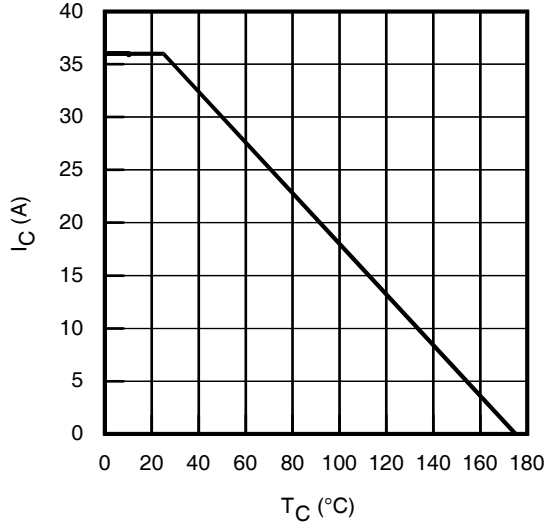
	Parameter	Min.	Typ.	Max.	Units	Conditions	Ref.Fig
V <sub>(BR)CES</sub>	Collector-to-Emitter Breakdown Voltage	600	—	—	V	V <sub>GE</sub> = 0V, I <sub>C</sub> = 100μA ④	CT6
ΔV <sub>(BR)CES</sub> /ΔT <sub>J</sub>	Temperature Coeff. of Breakdown Voltage	—	0.40	—	V/°C	V <sub>GE</sub> = 0V, I <sub>C</sub> = 1mA (25°C-175°C)	CT6
V <sub>CE(on)</sub>	Collector-to-Emitter Saturation Voltage	—	1.65	1.95	V	I <sub>C</sub> = 18A, V <sub>GE</sub> = 15V, T <sub>J</sub> = 25°C	5,6,7
		—	2.05	—		I <sub>C</sub> = 18A, V <sub>GE</sub> = 15V, T <sub>J</sub> = 150°C	9,10,11
		—	2.15	—		I <sub>C</sub> = 18A, V <sub>GE</sub> = 15V, T <sub>J</sub> = 175°C	
V <sub>GE(th)</sub>	Gate Threshold Voltage	4.0	—	6.5	V	V <sub>CE</sub> = V <sub>GE</sub> , I <sub>C</sub> = 500μA	9, 10,
ΔV <sub>GE(th)</sub> /ΔT <sub>J</sub>	Threshold Voltage temp. coefficient	—	-18	—	mV/°C	V <sub>CE</sub> = V <sub>GE</sub> , I <sub>C</sub> = 1.0mA (25°C - 175°C)	11, 12
g <sub>fe</sub>	Forward Transconductance	—	12	—	S	V <sub>CE</sub> = 50V, I <sub>C</sub> = 18A, PW = 80μs	
I <sub>CES</sub>	Collector-to-Emitter Leakage Current	—	2.0	25	μA	V <sub>GE</sub> = 0V, V <sub>CE</sub> = 600V	
		—	550	—		V <sub>GE</sub> = 0V, V <sub>CE</sub> = 600V, T <sub>J</sub> = 175°C	
V <sub>FM</sub>	Diode Forward Voltage Drop	—	2.30	3.30	V	I <sub>F</sub> = 18A	8
		—	1.6	—		I <sub>F</sub> = 18A, T <sub>J</sub> = 175°C	
I <sub>GES</sub>	Gate-to-Emitter Leakage Current	—	—	±100	nA	V <sub>GE</sub> = ±20V	

## Switching Characteristics @ T<sub>J</sub> = 25°C (unless otherwise specified)

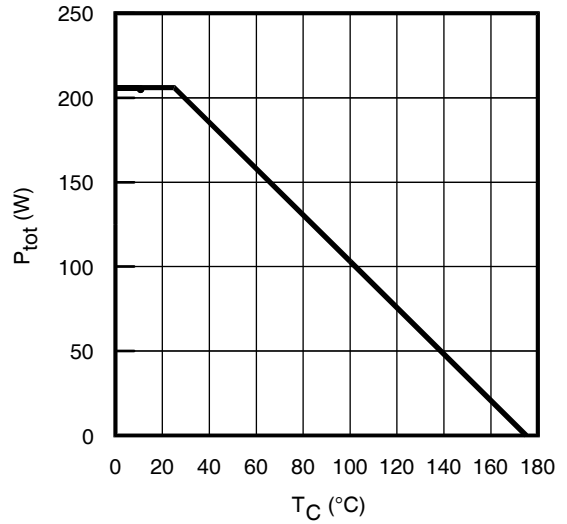
	Parameter	Min.	Typ.	Max.	Units	Conditions	Ref.Fig
Q <sub>g</sub>	Total Gate Charge (turn-on)	—	35	55	nC	I <sub>C</sub> = 18A	24
Q <sub>ge</sub>	Gate-to-Emitter Charge (turn-on)	—	10	15		V <sub>GE</sub> = 15V	CT1
Q <sub>gc</sub>	Gate-to-Collector Charge (turn-on)	—	15	25		V <sub>CC</sub> = 400V	
E <sub>on</sub>	Turn-On Switching Loss	—	95	140	μJ	I <sub>C</sub> = 18A, V <sub>CC</sub> = 400V, V <sub>GE</sub> = 15V	CT4
E <sub>off</sub>	Turn-Off Switching Loss	—	350	405		R <sub>G</sub> = 22Ω, L = 200μH, L <sub>S</sub> = 150nH	
E <sub>total</sub>	Total Switching Loss	—	445	545		Energy losses include tail & diode reverse recovery	
t <sub>d(on)</sub>	Turn-On delay time	—	40	55	ns	I <sub>C</sub> = 18A, V <sub>CC</sub> = 400V, V <sub>GE</sub> = 15V	CT4
t <sub>r</sub>	Rise time	—	25	35		R <sub>G</sub> = 22Ω, L = 200μH, L <sub>S</sub> = 150nH	
t <sub>d(off)</sub>	Turn-Off delay time	—	105	120			
t <sub>f</sub>	Fall time	—	25	35			
E <sub>on</sub>	Turn-On Switching Loss	—	285	—		μJ	I <sub>C</sub> = 18A, V <sub>CC</sub> = 400V, V <sub>GE</sub> = 15V
E <sub>off</sub>	Turn-Off Switching Loss	—	570	—	R <sub>G</sub> = 22Ω, L = 200μH, L <sub>S</sub> = 150nH, T <sub>J</sub> = 175°C ④		CT4
E <sub>total</sub>	Total Switching Loss	—	855	—	Energy losses include tail & diode reverse recovery		WF1, WF2
t <sub>d(on)</sub>	Turn-On delay time	—	40	—	ns	I <sub>C</sub> = 18A, V <sub>CC</sub> = 400V, V <sub>GE</sub> = 15V	14, 16
t <sub>r</sub>	Rise time	—	25	—		R <sub>G</sub> = 22Ω, L = 200μH, L <sub>S</sub> = 150nH	CT4
t <sub>d(off)</sub>	Turn-Off delay time	—	120	—		T <sub>J</sub> = 175°C	WF1
t <sub>f</sub>	Fall time	—	40	—			WF2
C <sub>ies</sub>	Input Capacitance	—	1043	—	pF	V <sub>GE</sub> = 0V	23
C <sub>oes</sub>	Output Capacitance	—	87	—		V <sub>CC</sub> = 30V	
C <sub>res</sub>	Reverse Transfer Capacitance	—	32	—		f = 1.0Mhz	
RBSOA	Reverse Bias Safe Operating Area	FULL SQUARE				T <sub>J</sub> = 175°C, I <sub>C</sub> = 72A V <sub>CC</sub> = 480V, V <sub>p</sub> = 600V R <sub>G</sub> = 22Ω, V <sub>GE</sub> = +15V to 0V	4 CT2
SCSOA	Short Circuit Safe Operating Area	5	—	—	μs	V <sub>CC</sub> = 400V, V <sub>p</sub> = 600V R <sub>G</sub> = 22Ω, V <sub>GE</sub> = +15V to 0V	22, CT3 WF4
E <sub>rec</sub>	Reverse Recovery Energy of the Diode	—	260	—	μJ	T <sub>J</sub> = 175°C	17, 18, 19
t <sub>rr</sub>	Diode Reverse Recovery Time	—	100	—	ns	V <sub>CC</sub> = 400V, I <sub>F</sub> = 18A	20, 21
I <sub>rr</sub>	Peak Reverse Recovery Current	—	23	—	A	V <sub>GE</sub> = 15V, R <sub>G</sub> = 22Ω, L = 200μH, L <sub>S</sub> = 150nH	WF3

### Notes:

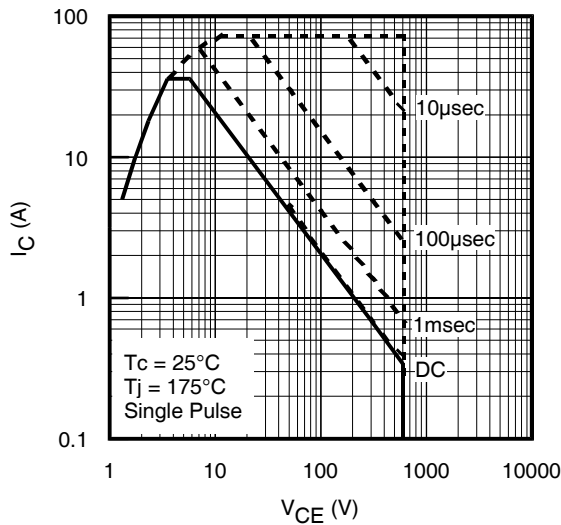
- ① V<sub>CC</sub> = 80% (V<sub>CES</sub>), V<sub>GE</sub> = 20V, L = 100μH, R<sub>G</sub> = 22Ω.
- ② This is only applied to TO-220AB package.
- ③ Pulse width limited by max. junction temperature.
- ④ Refer to AN-1086 for guidelines for measuring V<sub>(BR)CES</sub> safely.



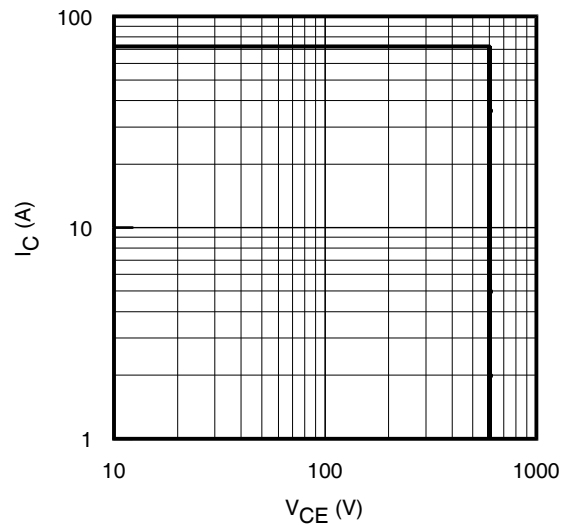
**Fig. 1** - Maximum DC Collector Current vs. Case Temperature



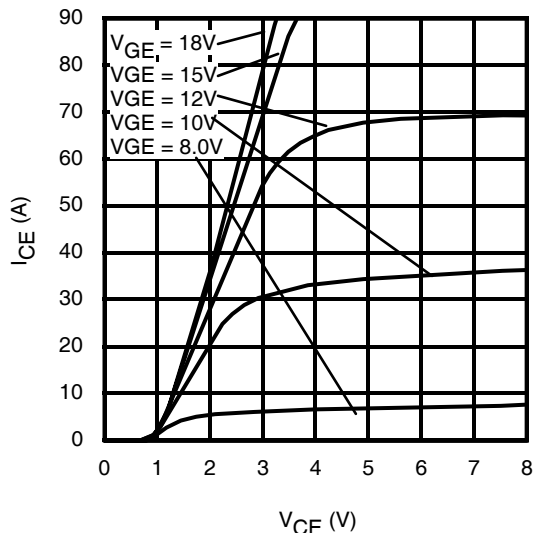
**Fig. 2** - Power Dissipation vs. Case Temperature



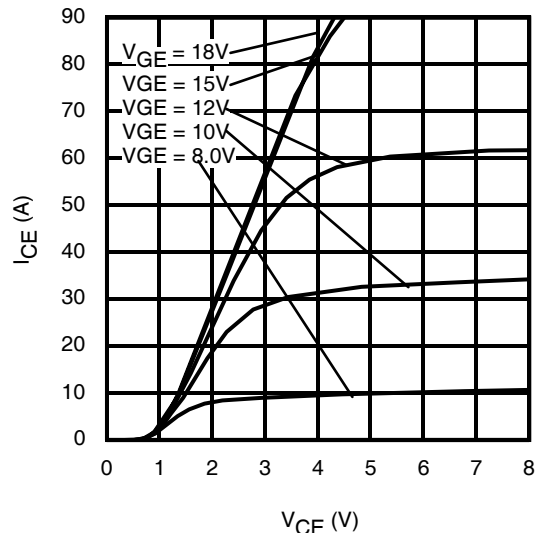
**Fig. 3** - Forward SOA  
 $T_C = 25^{\circ}C$ ,  $T_J \leq 175^{\circ}C$ ;  $V_{GE} = 15V$



**Fig. 4** - Reverse Bias SOA  
 $T_J = 175^{\circ}C$ ;  $V_{GE} = 15V$

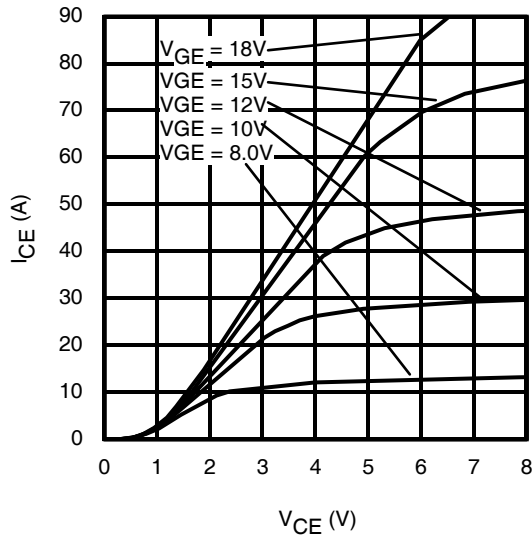


**Fig. 5** - Typ. IGBT Output Characteristics  
 $T_J = -40^{\circ}C$ ;  $t_p = 80\mu s$

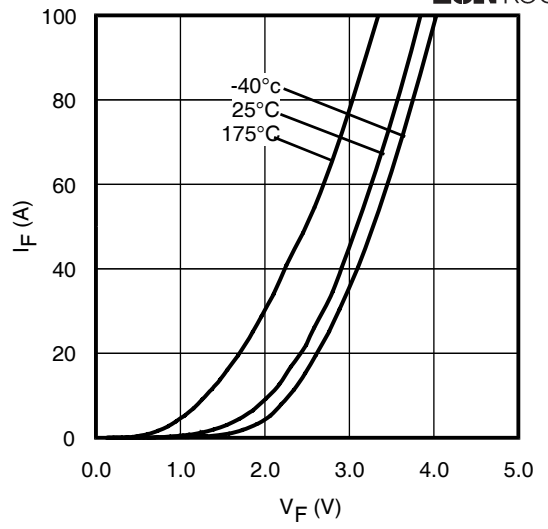


**Fig. 6** - Typ. IGBT Output Characteristics  
 $T_J = 25^{\circ}C$ ;  $t_p = 80\mu s$

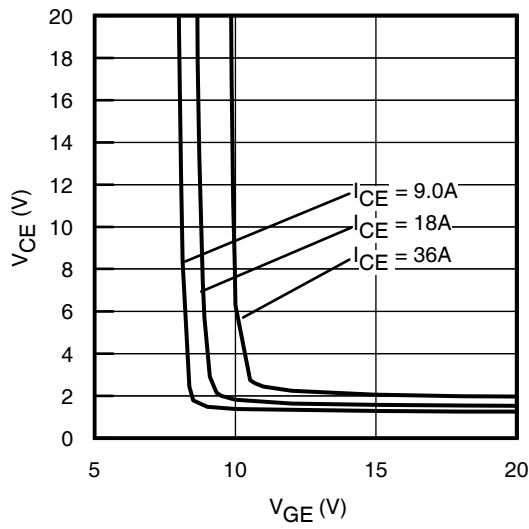
# IRGB4061DPbF



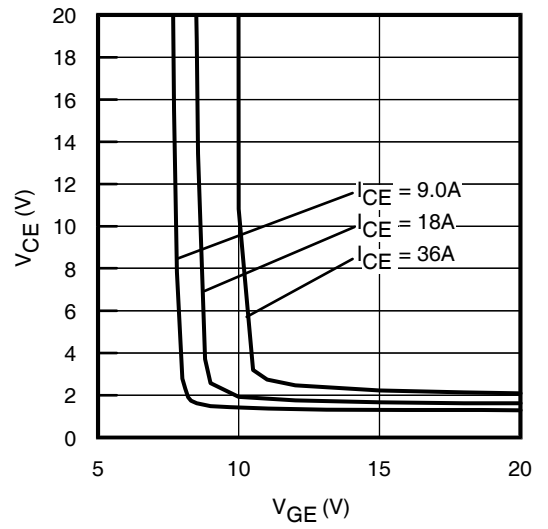
**Fig. 7** - Typ. IGBT Output Characteristics  
 $T_J = 175^\circ\text{C}$ ;  $t_p = 80\mu\text{s}$



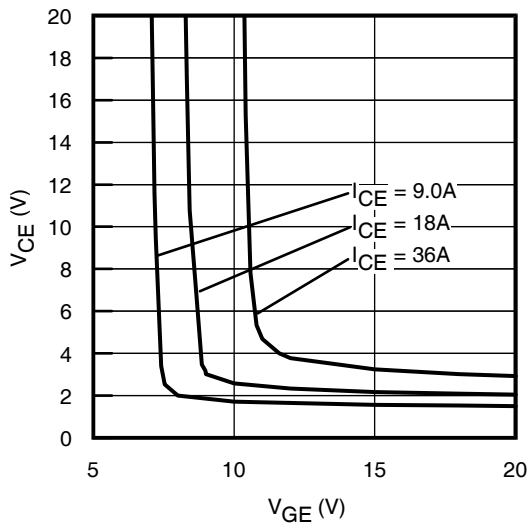
**Fig. 8** - Typ. Diode Forward Characteristics  
 $t_p = 80\mu\text{s}$



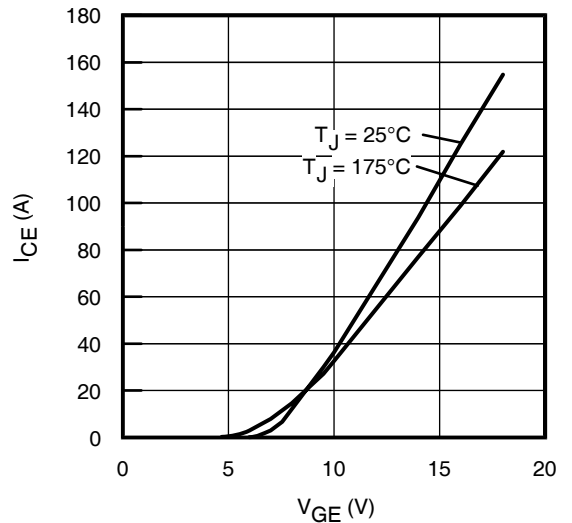
**Fig. 9** - Typical  $V_{CE}$  vs.  $V_{GE}$   
 $T_J = -40^\circ\text{C}$



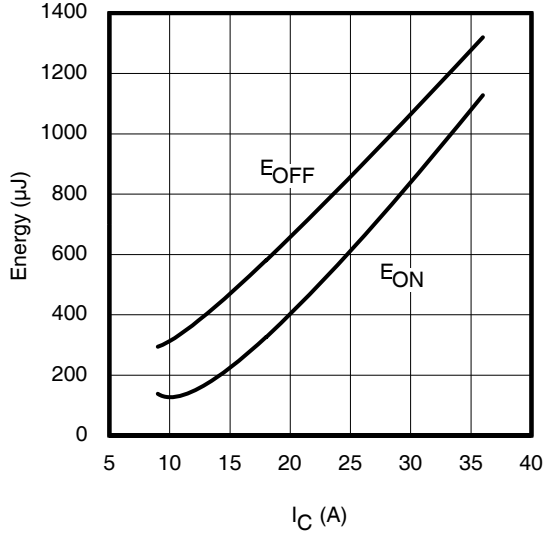
**Fig. 10** - Typical  $V_{CE}$  vs.  $V_{GE}$   
 $T_J = 25^\circ\text{C}$



**Fig. 11** - Typical  $V_{CE}$  vs.  $V_{GE}$   
 $T_J = 175^\circ\text{C}$

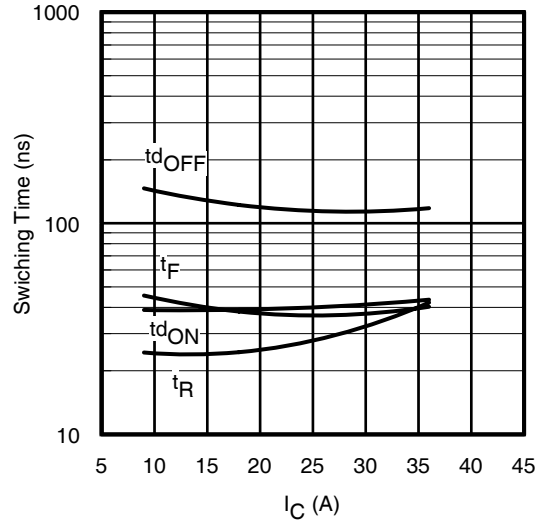


**Fig. 12** - Typ. Transfer Characteristics  
 $V_{CE} = 50\text{V}$ ;  $t_p = 10\mu\text{s}$



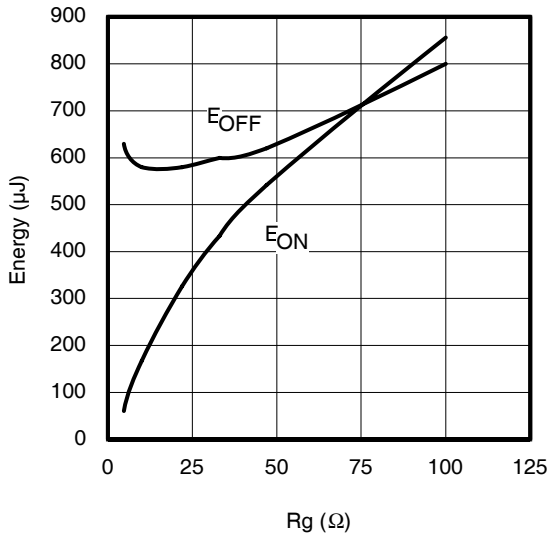
**Fig. 13** - Typ. Energy Loss vs.  $I_C$

$T_J = 175^\circ\text{C}$ ;  $L = 200\mu\text{H}$ ;  $V_{CE} = 400\text{V}$ ;  $R_G = 22\Omega$ ;  $V_{GE} = 15\text{V}$



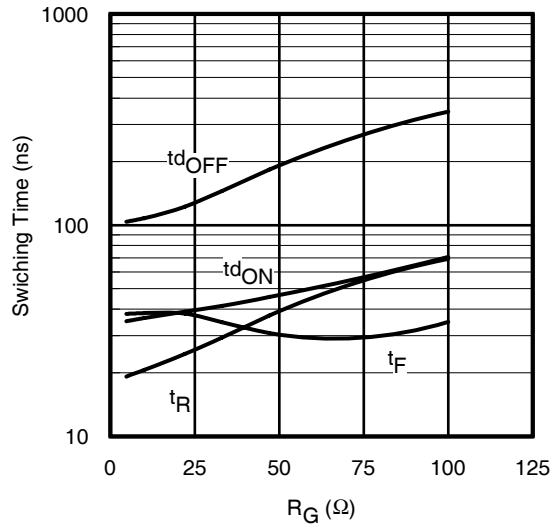
**Fig. 14** - Typ. Switching Time vs.  $I_C$

$T_J = 175^\circ\text{C}$ ;  $L = 200\mu\text{H}$ ;  $V_{CE} = 400\text{V}$ ;  $R_G = 22\Omega$ ;  $V_{GE} = 15\text{V}$



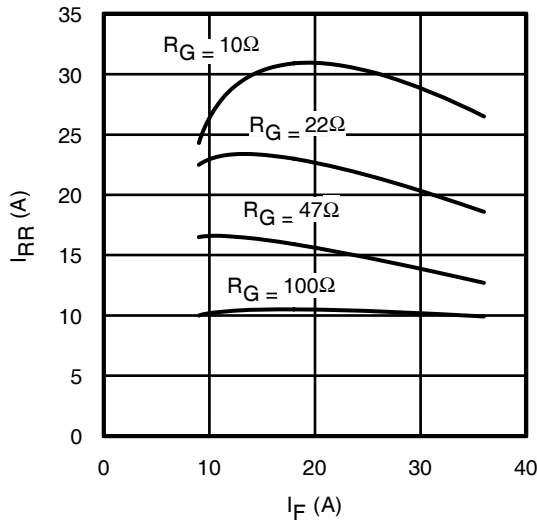
**Fig. 15** - Typ. Energy Loss vs.  $R_G$

$T_J = 175^\circ\text{C}$ ;  $L = 200\mu\text{H}$ ;  $V_{CE} = 400\text{V}$ ;  $I_{CE} = 18\text{A}$ ;  $V_{GE} = 15\text{V}$



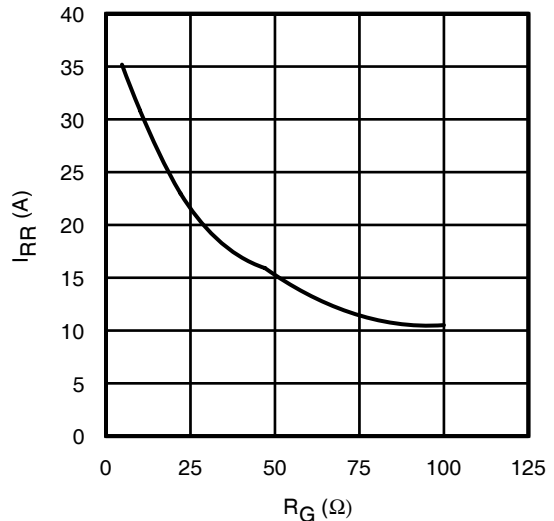
**Fig. 16** - Typ. Switching Time vs.  $R_G$

$T_J = 175^\circ\text{C}$ ;  $L = 200\mu\text{H}$ ;  $V_{CE} = 400\text{V}$ ;  $I_{CE} = 18\text{A}$ ;  $V_{GE} = 15\text{V}$



**Fig. 17** - Typ. Diode  $I_{RR}$  vs.  $I_F$

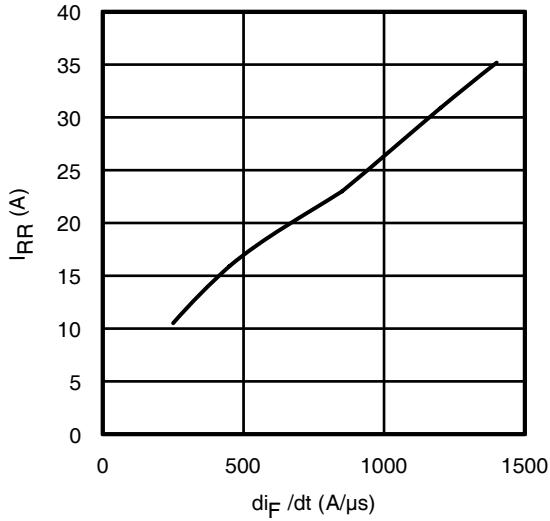
$T_J = 175^\circ\text{C}$



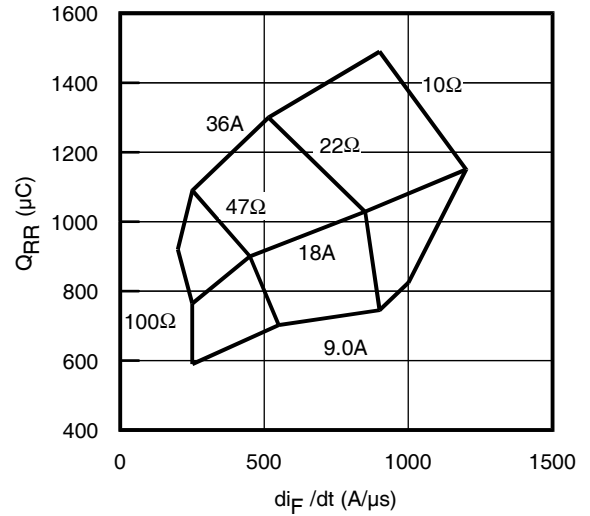
**Fig. 18** - Typ. Diode  $I_{RR}$  vs.  $R_G$

$T_J = 175^\circ\text{C}$

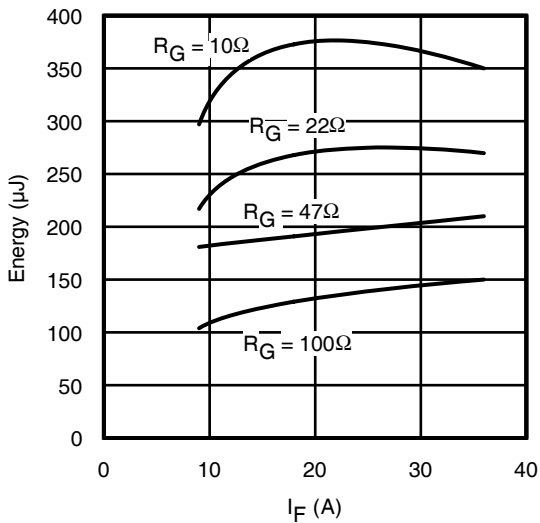
# IRGB4061DPbF



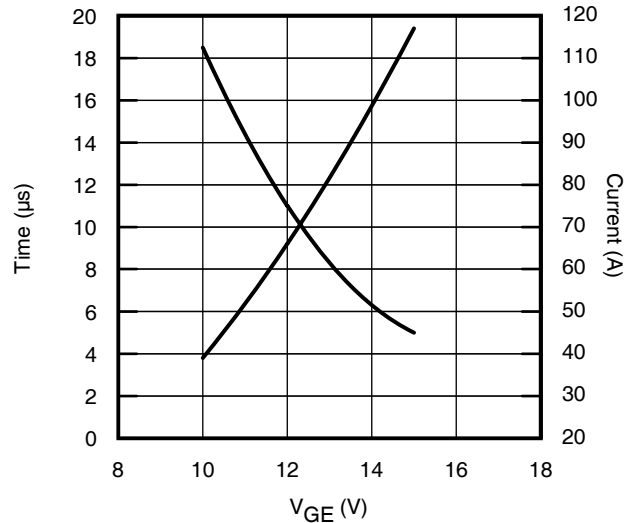
**Fig. 19** - Typ. Diode  $I_{RR}$  vs.  $di_F/dt$   
 $V_{CC} = 400V$ ;  $V_{GE} = 15V$ ;  $I_F = 18A$ ;  $T_J = 175^\circ C$



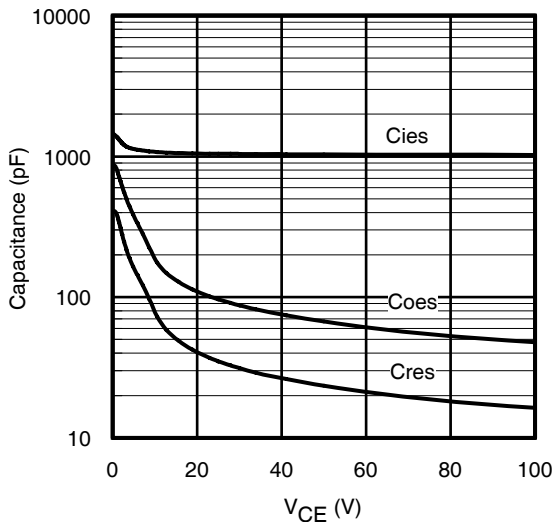
**Fig. 20** - Typ. Diode  $Q_{RR}$  vs.  $di_F/dt$   
 $V_{CC} = 400V$ ;  $V_{GE} = 15V$ ;  $T_J = 175^\circ C$



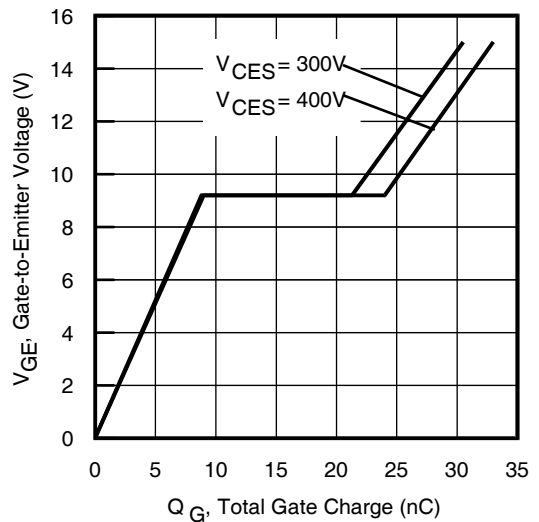
**Fig. 21** - Typ. Diode  $E_{RR}$  vs.  $I_F$   
 $T_J = 175^\circ C$



**Fig. 22** -  $V_{GE}$  vs. Short Circuit Time  
 $V_{CC} = 400V$ ;  $T_C = 25^\circ C$



**Fig. 23** - Typ. Capacitance vs.  $V_{CE}$



**Fig. 24** - Typical Gate Charge vs.  $V_{GE}$

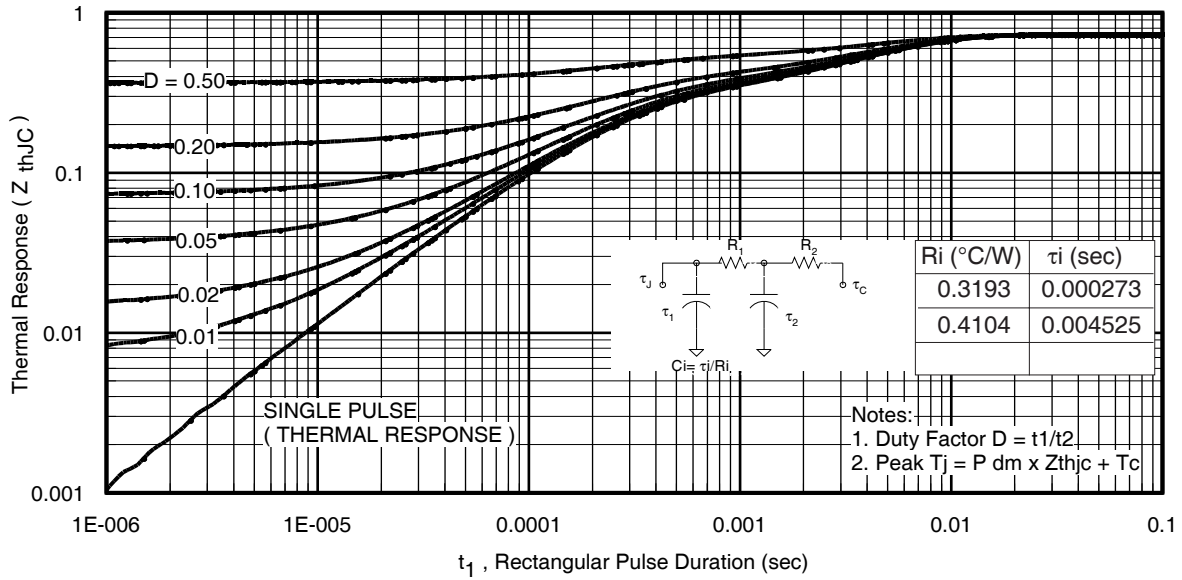


Fig 25. Maximum Transient Thermal Impedance, Junction-to-Case (IGBT)

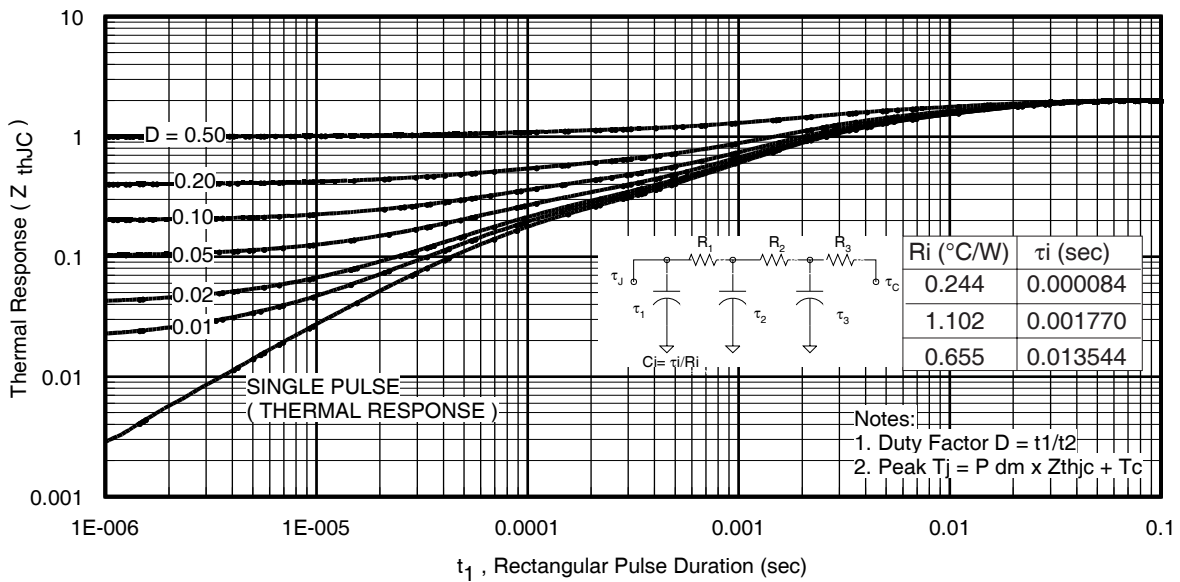
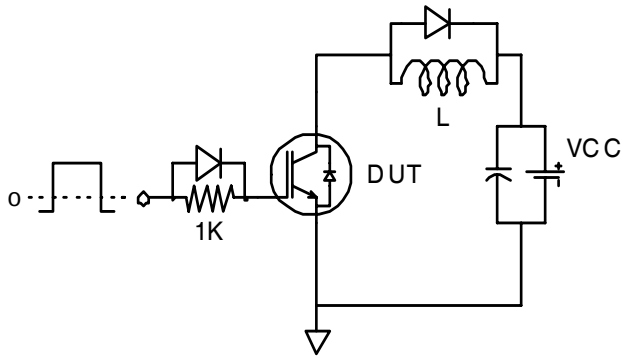
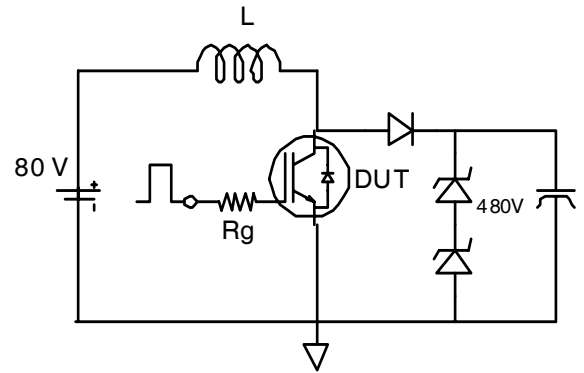


Fig. 26. Maximum Transient Thermal Impedance, Junction-to-Case (DIODE)

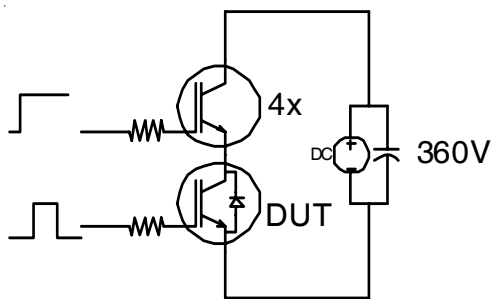
# IRGB4061DPbF



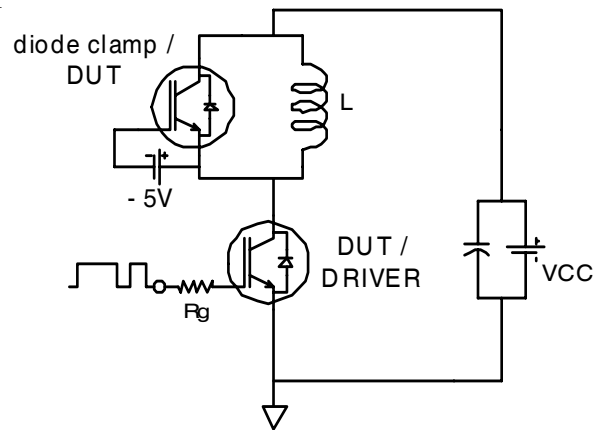
**Fig.C.T.1** - Gate Charge Circuit (turn-off)



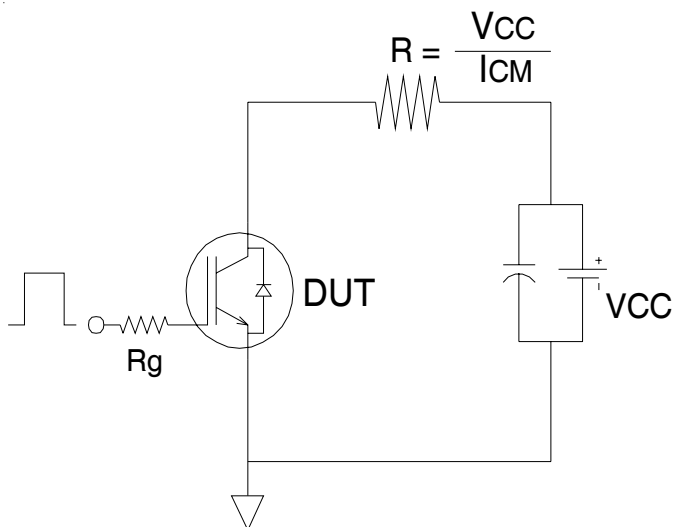
**Fig.C.T.2** - RBSOA Circuit



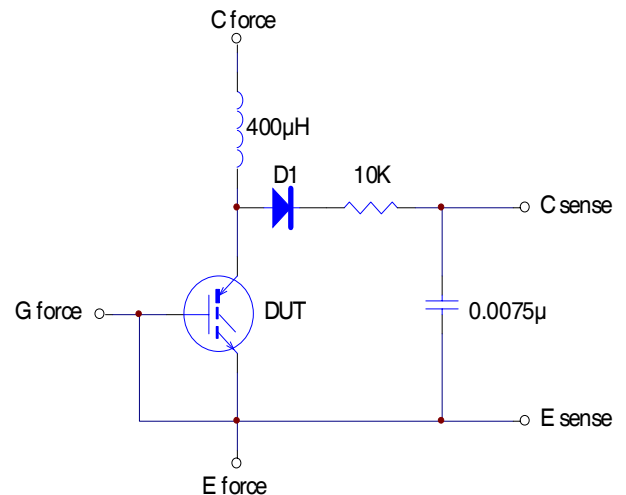
**Fig.C.T.3** - S.C. SOA Circuit



**Fig.C.T.4** - Switching Loss Circuit

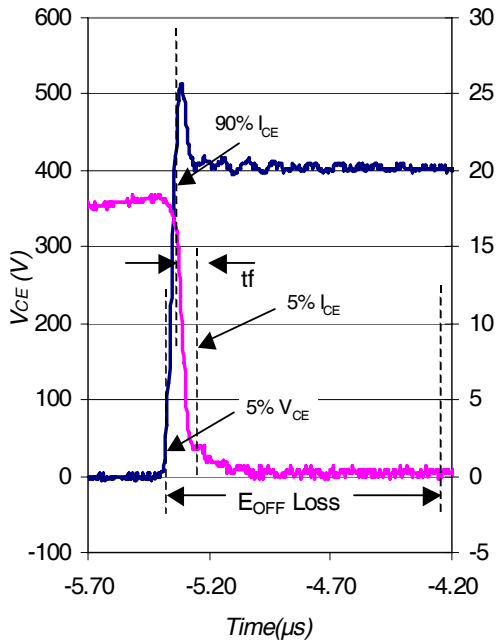


**Fig.C.T.5** - Resistive Load Circuit

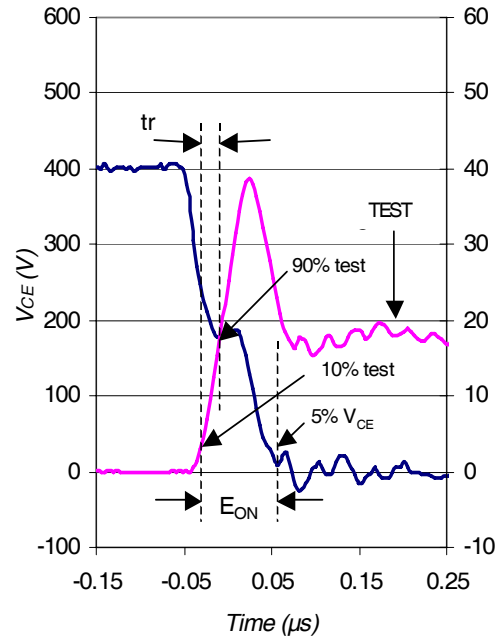


**Fig.C.T.6** - BVCES Filter Circuit

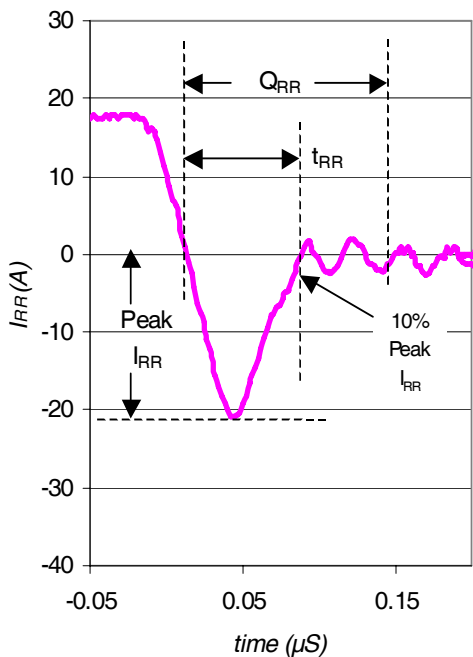




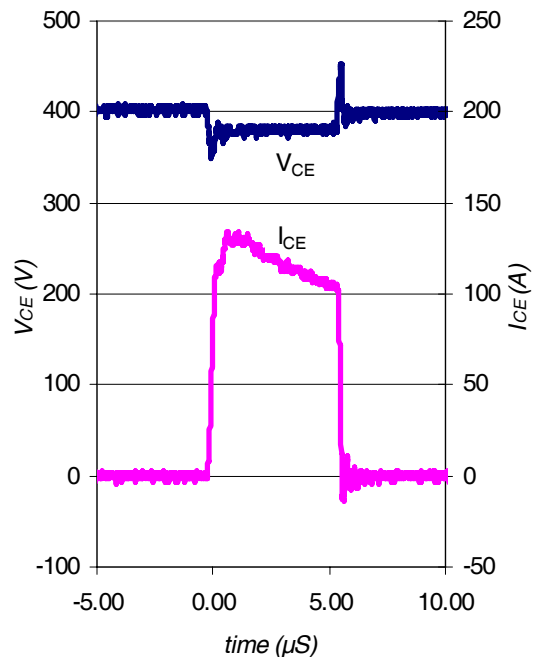
**Fig. WF1** - Typ. Turn-off Loss Waveform  
 @  $T_J = 175^\circ\text{C}$  using Fig. CT.4



**Fig. WF2** - Typ. Turn-on Loss Waveform  
 @  $T_J = 175^\circ\text{C}$  using Fig. CT.4



**Fig. WF3** - Typ. Diode Recovery Waveform  
 @  $T_J = 175^\circ\text{C}$  using Fig. CT.4

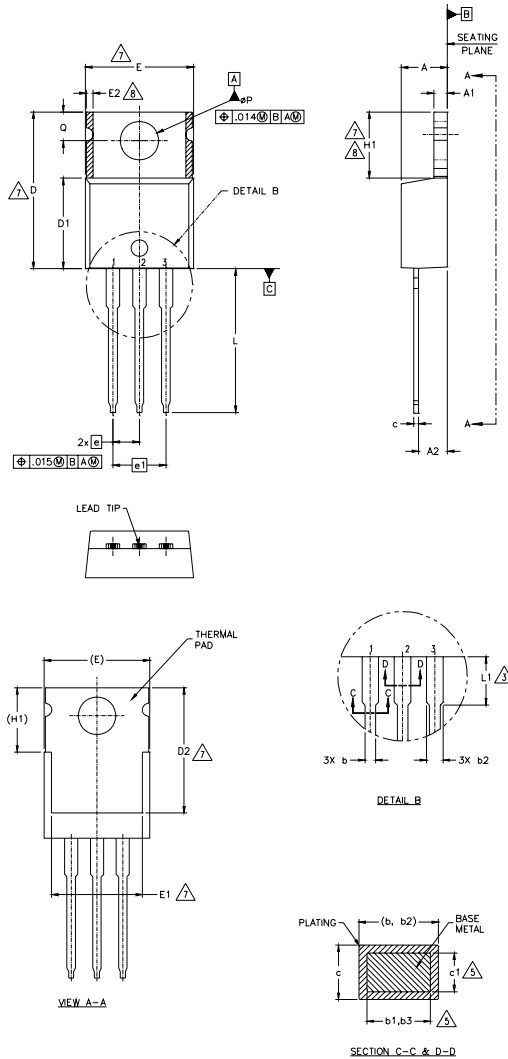


**Fig. WF4** - Typ. S.C. Waveform  
 @  $T_J = 25^\circ\text{C}$  using Fig. CT.3

# IRGB4061DPbF

TO-220AB Package Outline (Dimensions are shown in millimeters (inches))

International  
**IR** Rectifier



**NOTES:**

- 1.- DIMENSIONING AND TOLERANCING AS PER ASME Y14.5 M- 1994.
- 2.- DIMENSIONS ARE SHOWN IN INCHES [MILLIMETERS].
- 3.- LEAD DIMENSION AND FINISH UNCONTROLLED IN L1.
- 4.- DIMENSION D, D1 & E DO NOT INCLUDE MOLD FLASH. MOLD FLASH SHALL NOT EXCEED .005" (0.127) PER SIDE. THESE DIMENSIONS ARE MEASURED AT THE OUTERMOST EXTREMES OF THE PLASTIC BODY.
- 5.- DIMENSION b1, b3 & c1 APPLY TO BASE METAL ONLY.
- 6.- CONTROLLING DIMENSION : INCHES.
- 7.- THERMAL PAD CONTOUR OPTIONAL WITHIN DIMENSIONS E,H1,D2 & E1
- 8.- DIMENSION E2 X H1 DEFINE A ZONE WHERE STAMPING AND SINGULATION IRREGULARITIES ARE ALLOWED.
- 9.- OUTLINE CONFORMS TO JEDEC TO-220, EXCEPT A2 (max.) AND D2 (min.) WHERE DIMENSIONS ARE DERIVED FROM THE ACTUAL PACKAGE OUTLINE.

SYMBOL	DIMENSIONS				NOTES
	MILLIMETERS		INCHES		
	MIN.	MAX.	MIN.	MAX.	
A	3.56	4.83	.140	.190	
A1	0.51	1.40	.020	.055	
A2	2.03	2.92	.080	.115	
b	0.38	1.01	.015	.040	
b1	0.38	0.97	.015	.038	5
b2	1.14	1.78	.045	.070	
b3	1.14	1.73	.045	.068	5
c	0.36	0.61	.014	.024	
c1	0.36	0.56	.014	.022	5
D	14.22	16.51	.560	.650	4
D1	8.38	9.02	.330	.355	
D2	11.68	12.88	.460	.507	7
E	9.65	10.67	.380	.420	4,7
E1	6.86	8.89	.270	.350	7
E2	-	0.76	-	.030	8
e	2.54 BSC		.100 BSC		
e1	5.08 BSC		.200 BSC		
H1	5.84	6.86	.230	.270	7,8
L	12.70	14.73	.500	.580	
L1	-	6.35	-	.250	3
∅P	3.54	4.08	.139	.161	
Q	2.54	3.42	.100	.135	

**LEAD ASSIGNMENTS**

- HEXFET**
- 1.- GATE
  - 2.- DRAIN
  - 3.- SOURCE

**IGBTs, CoPACK**

- 1.- GATE
- 2.- COLLECTOR
- 3.- EMITTER

**DIODES**

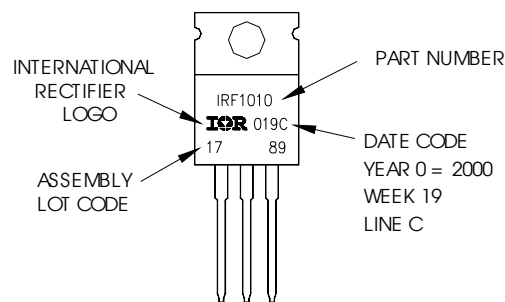
- 1.- ANODE/OPEN
- 2.- CATHODE
- 3.- ANODE

10- For the most current drawing please refer to IR website at <http://www.irf.com/package/pkight.html>

## TO-220AB Part Marking Information

EXAMPLE: THIS IS AN IRF1010  
LOT CODE 1789  
ASSEMBLED ON WW 19, 2000  
IN THE ASSEMBLY LINE "C"

Note: "P" in assembly line position indicates "Lead - Free"



TO-220AB packages are not recommended for Surface Mount Application.

Data and specifications subject to change without notice.  
This product has been designed and qualified for Industrial market.  
Qualification Standards can be found on IR's Web site.

International  
**IR** Rectifier

IR WORLD HEADQUARTERS: 233 Kansas St., El Segundo, California 90245, USA Tel: (310) 252-7105  
TAC Fax: (310) 252-7903

Visit us at [www.irf.com](http://www.irf.com) for sales contact information. 09/07