

# International IOR Rectifier

## PDP TRENCH IGBT

# IRGI4065PbF

### Features

- Advanced Trench IGBT Technology
- Optimized for Sustain and Energy Recovery circuits in PDP applications
- Low  $V_{CE(on)}$  and Energy per Pulse ( $E_{PULSE}^{TM}$ ) for improved panel efficiency
- High repetitive peak current capability
- Lead Free package

Key Parameters		
$V_{CE\ min}$	300	V
$V_{CE(ON)\ typ. @ I_C = 28A}$	1.25	V
$I_{RP\ max @ T_C = 25^\circ C}$	170	A
$T_J\ max$	150	$^\circ C$

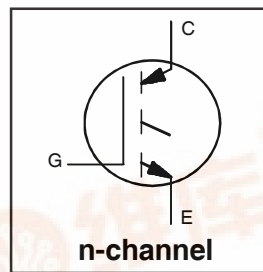

G	C	E
Gate	Collector	Emitter

### Description

This IGBT is specifically designed for applications in Plasma Display Panels. This device utilizes advanced trench IGBT technology to achieve low  $V_{CE(on)}$  and low  $E_{PULSE}^{TM}$  rating per silicon area which improve panel efficiency. Additional features are  $150^\circ C$  operating junction temperature and high repetitive peak current capability. These features combine to make this IGBT a highly efficient, robust and reliable device for PDP applications.

### Absolute Maximum Ratings

Parameter	Parameter	Max.	Units
$V_{GE}$	Gate-to-Emitter Voltage	$\pm 30$	V
$I_C @ T_C = 25^\circ C$	Continuous Collector Current, $V_{GE} @ 15V$	28	A
$I_C @ T_C = 100^\circ C$	Continuous Collector, $V_{GE} @ 15V$	14	A
$I_{RP} @ T_C = 25^\circ C$	Repetitive Peak Current ①	170	A
$P_D @ T_C = 25^\circ C$	Power Dissipation	39	W
$P_D @ T_C = 100^\circ C$	Power Dissipation	16	W
	Linear Derating Factor	0.31	W/ $^\circ C$
$T_J$	Operating Junction and	-40 to + 150	$^\circ C$
$T_{STG}$	Storage Temperature Range		$^\circ C$
	Soldering Temperature for 10 seconds	300	$^\circ C$
	Mounting Torque, 6-32 or M3 Screw	10lb·in (1.1N·m)	N

### Thermal Resistance

Parameter	Parameter	Typ.	Max.	Units
$R_{\theta JC}$	Junction-to-Case ②	—	3.20	$^\circ C/W$

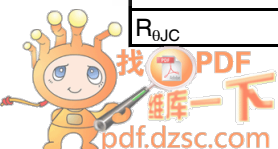

## Electrical Characteristics @ $T_J = 25^\circ\text{C}$ (unless otherwise specified)

	Parameter	Min.	Typ.	Max.	Units	Conditions
$BV_{CES}$	Collector-to-Emitter Breakdown Voltage	300	—	—	V	$V_{GE} = 0V, I_{CE} = 1\text{ mA}$
$V_{(BR)ECS}$	Emitter-to-Collector Breakdown Voltage <sup>①</sup>	18	—	—	V	$V_{GE} = 0V, I_{CE} = 1\text{ A}$
$\Delta BV_{CES}/\Delta T_J$	Breakdown Voltage Temp. Coefficient	—	0.23	—	V/ $^\circ\text{C}$	Reference to $25^\circ\text{C}$ , $I_{CE} = 1\text{ mA}$
$V_{CE(on)}$	Static Collector-to-Emitter Voltage	—	1.05	—	V	$V_{GE} = 15V, I_{CE} = 15A$ <sup>③</sup>
		—	1.25	1.45	V	$V_{GE} = 15V, I_{CE} = 28A$ <sup>③</sup>
		—	1.75	—	V	$V_{GE} = 15V, I_{CE} = 70A$ <sup>③</sup>
		—	2.25	—		$V_{GE} = 15V, I_{CE} = 110A$ <sup>③</sup>
		—	2.75	—	V	$V_{GE} = 15V, I_{CE} = 110A, T_J = 150^\circ\text{C}$ <sup>③</sup>
$V_{GE(th)}$	Gate Threshold Voltage	2.6	—	5.0	V	$V_{CE} = V_{GE}, I_{CE} = 0.5\text{ mA}$
$\Delta V_{GE(th)}/\Delta T_J$	Gate Threshold Voltage Coefficient	—	-12	—	mV/ $^\circ\text{C}$	
$I_{CES}$	Collector-to-Emitter Leakage Current	—	2.0	25	$\mu\text{A}$	$V_{CE} = 300V, V_{GE} = 0V$
		—	50	—		$V_{CE} = 300V, V_{GE} = 0V, T_J = 150^\circ\text{C}$
$I_{GES}$	Gate-to-Emitter Forward Leakage	—	—	100	nA	$V_{GE} = 30V$
	Gate-to-Emitter Reverse Leakage	—	—	-100		$V_{GE} = -30V$
$g_{fe}$	Forward Transconductance	—	26	—	S	$V_{CE} = 25V, I_{CE} = 25A$
$Q_g$	Total Gate Charge	—	62	—	nC	$V_{CE} = 200V, I_C = 25A, V_{GE} = 15V$ <sup>③</sup>
$Q_{gc}$	Gate-to-Collector Charge	—	20	—		
$t_{st}$	Shoot Through Blocking Time	100	—	—	ns	$V_{CC} = 240V, V_{GE} = 15V, R_G = 5.1\Omega$
$E_{PULSE}$	Energy per Pulse	—	875	—	$\mu\text{J}$	$L = 220\text{ nH}, C = 0.40\mu\text{F}, V_{GE} = 15V$ $V_{CC} = 240V, R_G = 5.1\Omega, T_J = 25^\circ\text{C}$
		—	975	—		$L = 220\text{ nH}, C = 0.40\mu\text{F}, V_{GE} = 15V$ $V_{CC} = 240V, R_G = 5.1\Omega, T_J = 100^\circ\text{C}$
$C_{iss}$	Input Capacitance	—	2200	—	pF	$V_{GE} = 0V$
$C_{oss}$	Output Capacitance	—	110	—		$V_{CE} = 30V$
$C_{rss}$	Reverse Transfer Capacitance	—	55	—		$f = 1.0\text{ MHz}$ , See Fig.13
$L_C$	Internal Collector Inductance	—	5.0	—	nH	Between lead, 6mm (0.25in.)
$L_E$	Internal Emitter Inductance	—	13	—		from package and center of die contact

### Notes:

- ① Half sine wave with duty cycle = 0.10,  $t_{on} = 2\mu\text{sec}$ .
- ②  $R_\theta$  is measured at  $T_J$  of approximately  $90^\circ\text{C}$ .
- ③ Pulse width  $\leq 400\mu\text{s}$ ; duty cycle  $\leq 2\%$ .

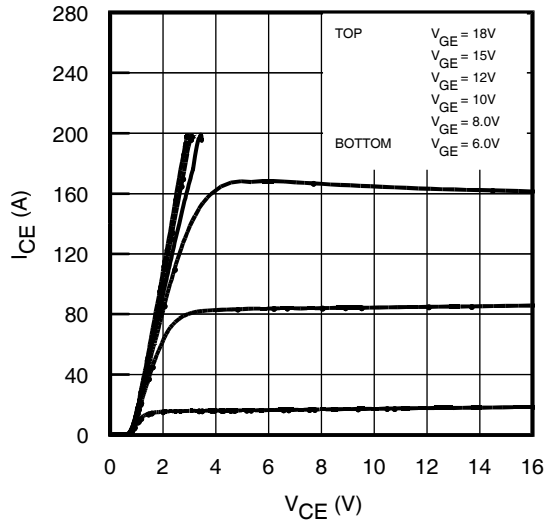

Fig 1. Typical Output Characteristics @  $25^{\circ}\text{C}$

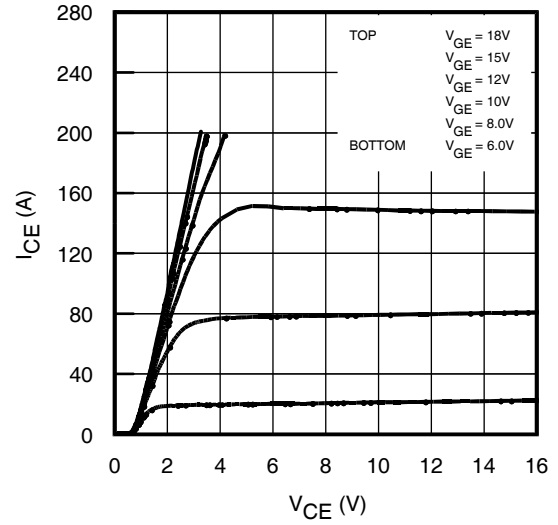

Fig 2. Typical Output Characteristics @  $75^{\circ}\text{C}$

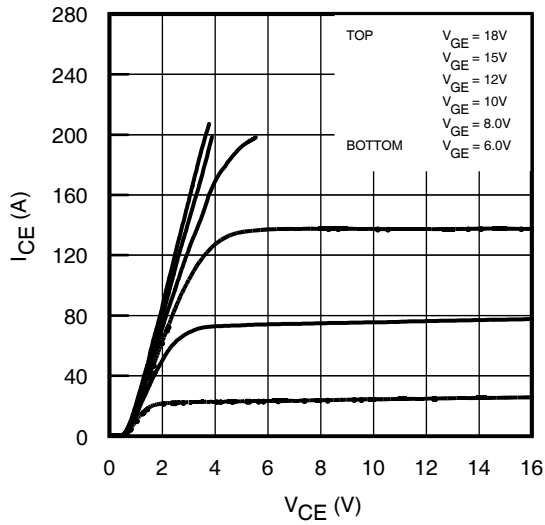

Fig 3. Typical Output Characteristics @  $125^{\circ}\text{C}$

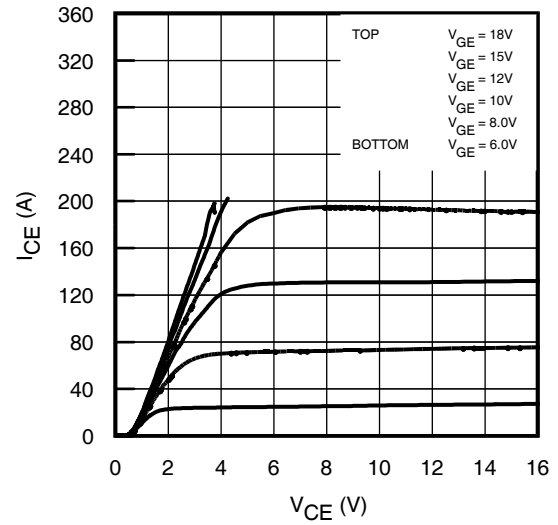

Fig 4. Typical Output Characteristics @  $150^{\circ}\text{C}$

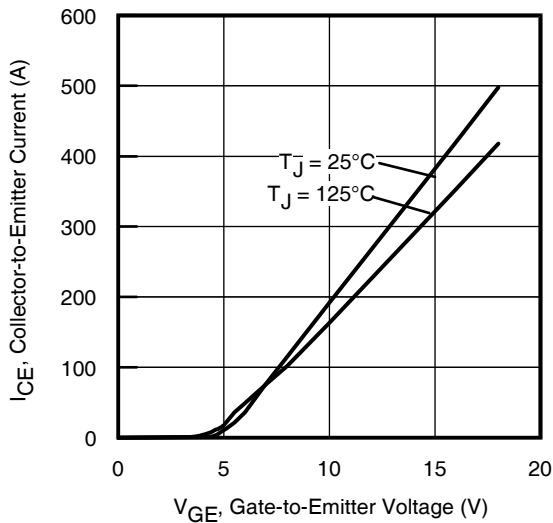

Fig 5. Typical Transfer Characteristics

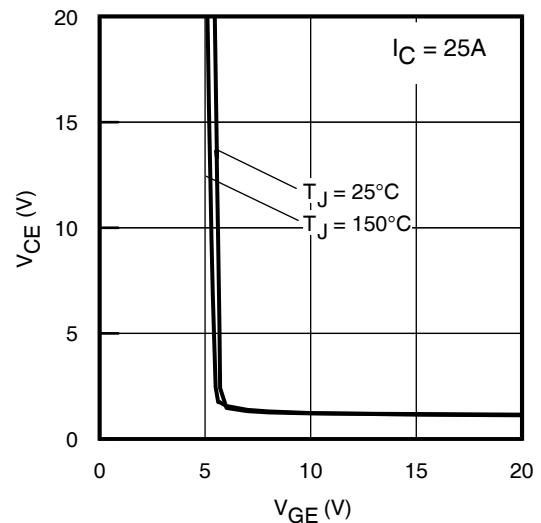

Fig 6.  $V_{CE(ON)}$  vs. Gate Voltage

# IRGI4065PbF

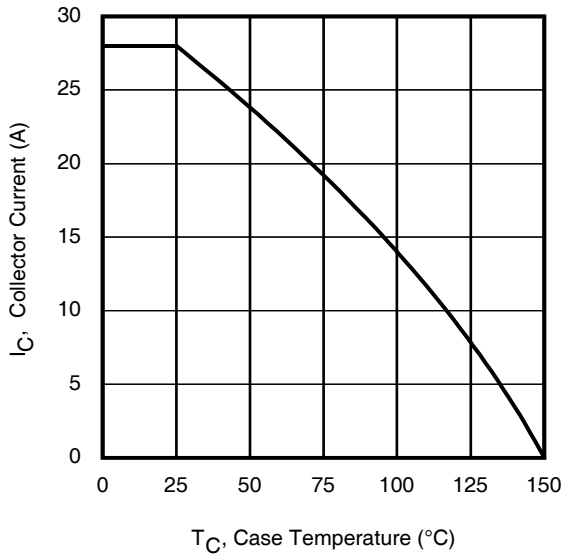

Fig 7. Maximum Collector Current vs. Case Temperature

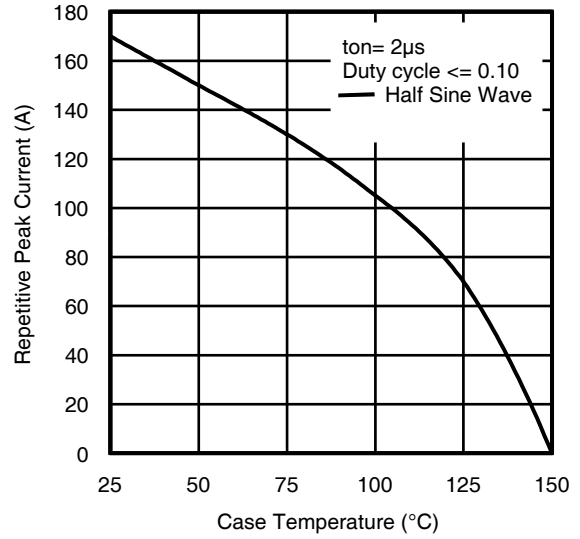

Fig 8. Typical Repetitive Peak Current vs. Case Temperature

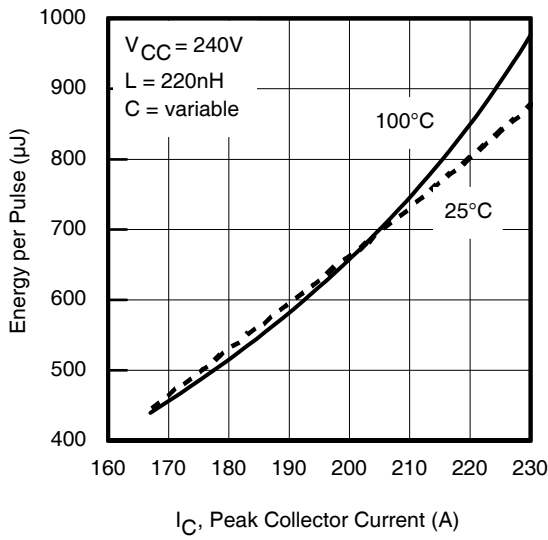

Fig 9. Typical  $E_{PULSE}$  vs. Collector Current

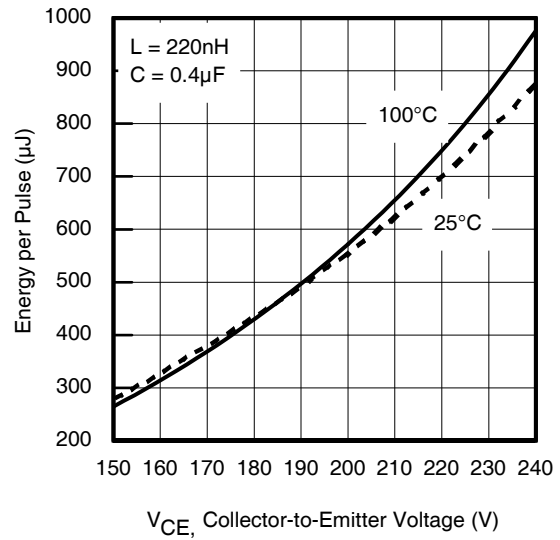

Fig 10. Typical  $E_{PULSE}$  vs. Collector-to-Emitter Voltage

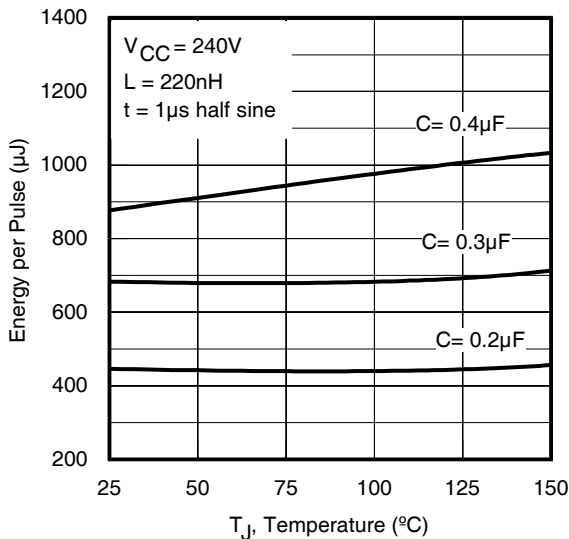

Fig 11.  $E_{PULSE}$  vs. Temperature

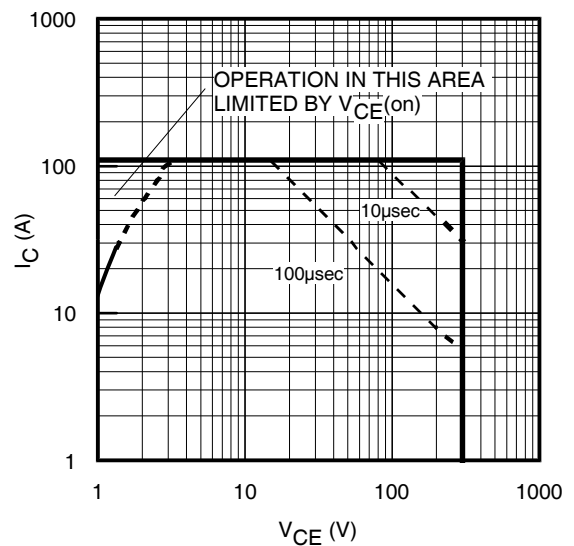

Fig 12. Forward Bias Safe Operating Area

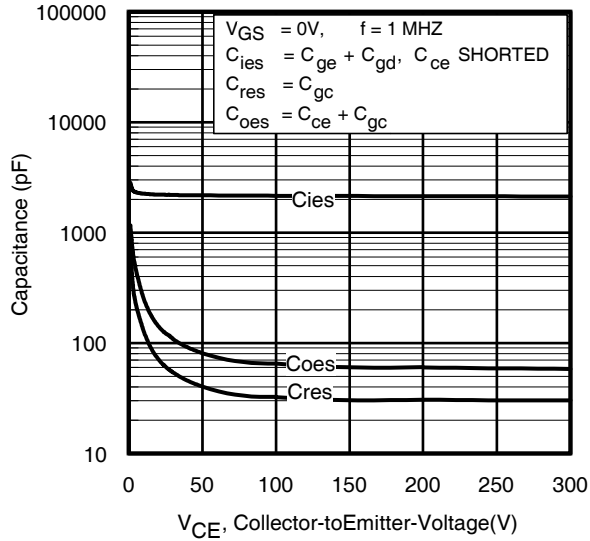

Fig 13. Typical Capacitance vs. Collector-to-Emitter Voltage

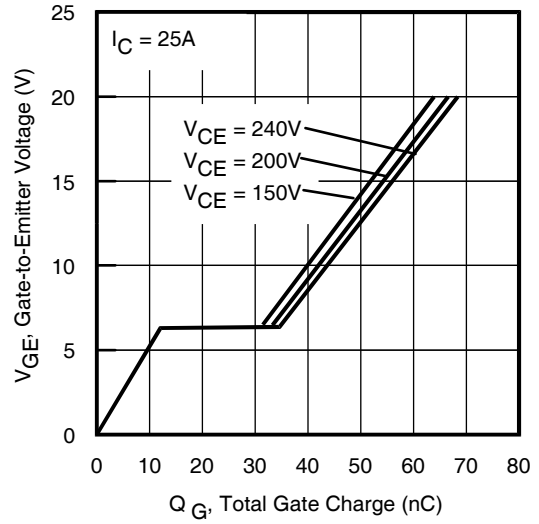

Fig 14. Typical Gate Charge vs. Gate-to-Emitter Voltage

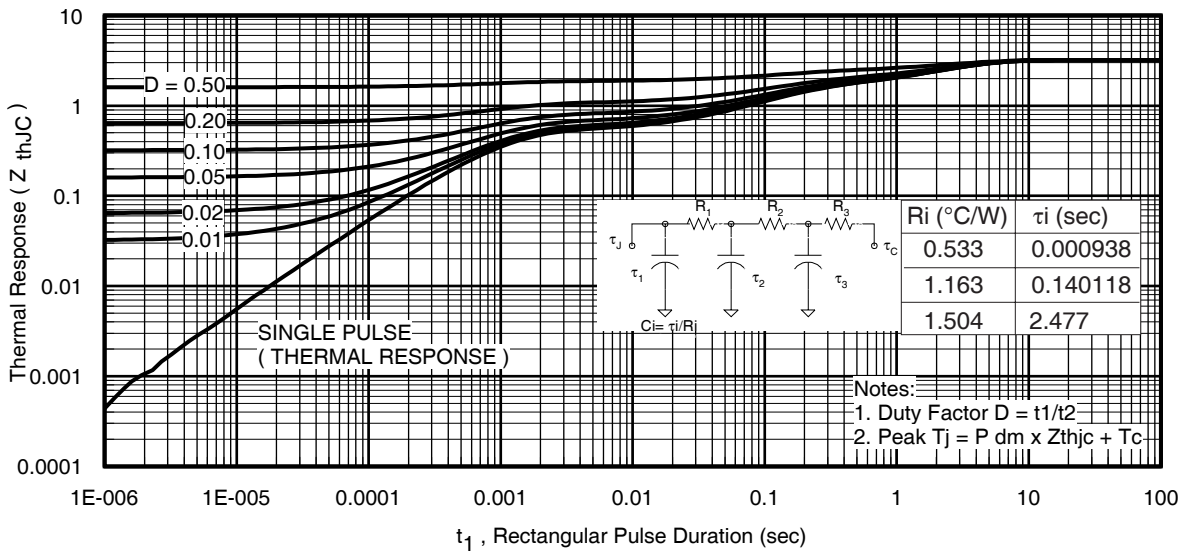
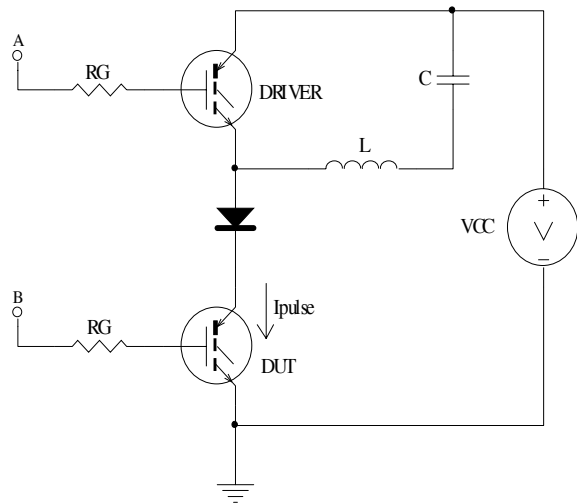
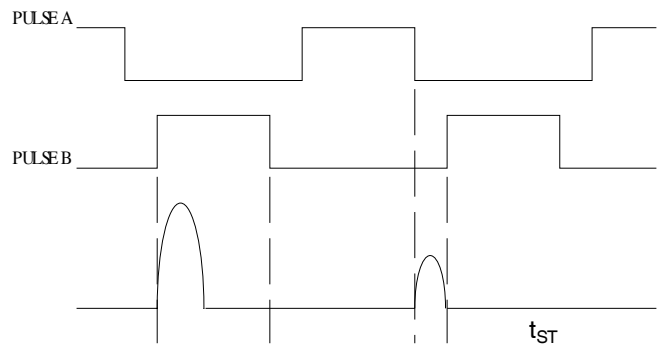

Fig 15. Maximum Effective Transient Thermal Impedance, Junction-to-Case



**Fig 16a.**  $t_{st}$  and  $E_{PULSE}$  Test Circuit



**Fig 16b.**  $t_{st}$  Test Waveforms

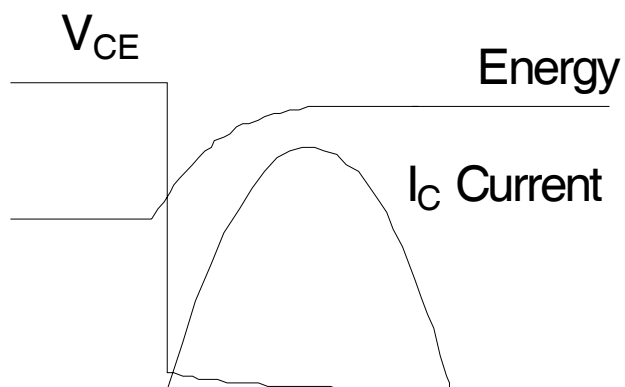

**Fig 16c.**  $E_{PULSE}$  Test Waveforms

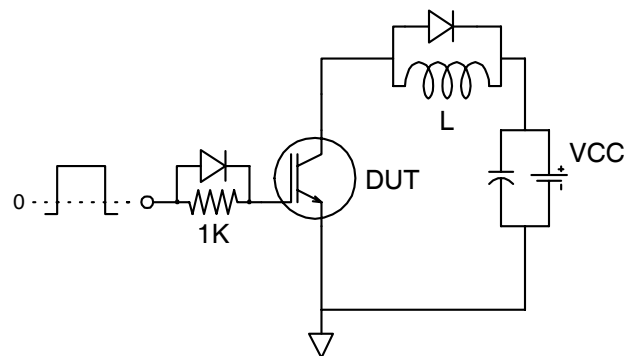

**Fig. 17 -** Gate Charge Circuit (turn-off)

## TO-220 Full-Pak Package Outline

Dimensions are shown in millimeters (inches)

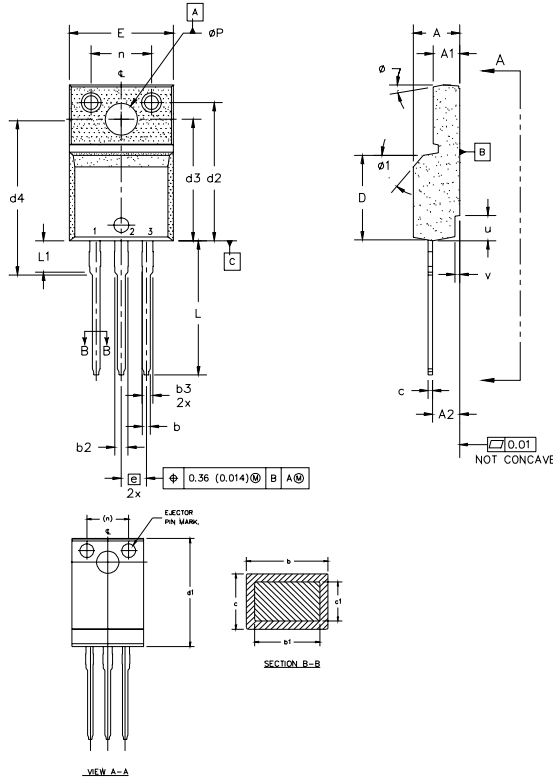

- NOTES:
- 1.0 DIMENSIONING AND TOLERANCING PER ASME Y14.5 M- 1994.
  - 2.0 DIMENSIONS ARE SHOWN IN MILLIMETERS [INCHES]
  - 3.0 LEAD DIMENSION AND FINISH UNCONTROLLED IN L1.
  - 4.0 DIMENSION D & E DO NOT INCLUDE MOLD FLASH. MOLD FLASH SHALL NOT EXCEED 0.005" (0.127) PER SIDE. THESE DIMENSIONS ARE MEASURED AT THE OUTERMOST EXTREMES OF THE PLASTIC BODY.
  - 5.0 DIMENSION d1 APPLY TO BASE METAL ONLY.
  - 6.0 STEP OPTIONAL ON PLASTIC BODY DEFINED BY DIMENSIONS u & v.
  - 7.0 CONTROLLING DIMENSION : INCHES.

SYMBOL	DIMENSIONS				NOTES	LEAD ASSIGNMENTS
	MILLIMETERS		INCHES			
	MIN.	MAX.	MIN.	MAX.		
A	4.57	4.83	0.180	0.190		
A1	2.57	2.85	0.101	0.114		
A2	2.51	2.85	0.099	0.112		
b	0.622	0.89	0.024	0.035		
b1	0.622	0.838	0.024	0.033	5	
b2	1.229	1.400	0.048	0.055		
b3	1.229	1.400	0.048	0.055		
c	0.440	0.629	0.017	0.025		
c1	0.440	0.584	0.017	0.023	4	
D	8.65	9.80	0.341	0.386		
d1	15.80	16.12	0.622	0.635		
d2	13.97	14.22	0.550	0.560		
d3	12.30	12.92	0.484	0.509		
d4	8.64	9.91	0.340	0.390	4	
E	10.36	10.63	0.408	0.419		
e	2.54 BSC		0.100 BSC			
L	13.20	13.73	0.520	0.541		
L1	3.10	3.50	0.122	0.138	3	
n	6.05	6.15	0.238	0.242		
øP	3.05	3.45	0.120	0.136		
u	2.40	2.50	0.094	0.098	6	
v	0.40	0.50	0.016	0.020	6	
ø	3"	7"	3"	7"		
ø1		45"		45"		

## TO-220 Full-Pak Part Marking Information

EXAMPLE: THIS IS AN IRFI840G  
WITH ASSEMBLY  
LOT CODE 3432  
ASSEMBLED ON WW 24, 2001  
IN THE ASSEMBLY LINE 'K'

Note: 'P' in assembly line position  
indicates 'Lead-Free'

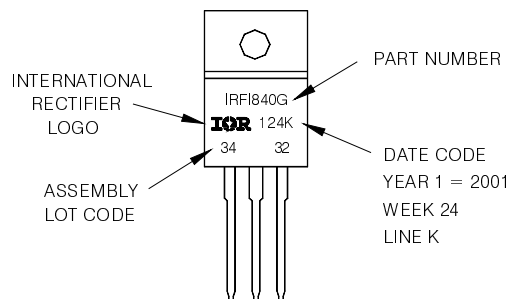

**TO-220AB Full-Pak package is not recommended for Surface Mount Application.**

The specifications set forth in this data sheet are the sole and exclusive specifications applicable to the identified product, and no specifications or features are implied whether by industry custom, sampling or otherwise. We qualify our products in accordance with our internal practices and procedures, which by their nature do not include qualification to all possible or even all widely used applications. Without limitation, we have not qualified our product for medical use or applications involving hi-reliability applications. Customers are encouraged to and responsible for qualifying product to their own use and their own application environments, especially where particular features are critical to operational performance or safety. Please contact your IR representative if you have specific design or use requirements or for further information.

Data and specifications subject to change without notice. This product has been designed for the Industrial market. Qualification Standards can be found on IR's Web site.