

International IR Rectifier

PD - 94913

IRGIB10B60KD1PbF

INSULATED GATE BIPOLAR TRANSISTOR WITH
ULTRAFAST SOFT RECOVERY DIODE

Features

- Low VCE (on) Non Punch Through IGBT Technology.
- Low Diode VF.
- 10µs Short Circuit Capability.
- Square RBSOA.
- Ultrasoft Diode Reverse Recovery Characteristics.
- Positive VCE (on) Temperature Coefficient.
- Maximum Junction Temperature Rated at 175°C
- Lead-Free

Benefits

- Benchmark Efficiency for Motor Control.
- Rugged Transient Performance.
- Low EMI.
- Excellent Current Sharing in Parallel Operation.

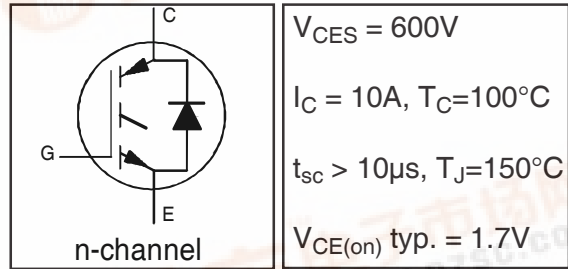

Absolute Maximum Ratings

	Parameter	Max.	Units
V_{CES}	Collector-to-Emitter Voltage	600	V
$I_C @ T_C = 25^\circ C$	Continuous Collector Current	16	A
$I_C @ T_C = 100^\circ C$	Continuous Collector Current	10	
I_{CM}	Pulse Collector Current (Ref.Fig.C.T.5)	32	
I_{LM}	Clamped Inductive Load current ①	32	
$I_F @ T_C = 25^\circ C$	Diode Continuous Forward Current	16	
$I_F @ T_C = 100^\circ C$	Diode Continuous Forward Current	10	V
I_{FM}	Diode Maximum Forward Current	32	
V_{ISOL}	RMS Isolation Voltage, Terminal to Case, $t = 1 \text{ min}$	2500	
V_{GE}	Gate-to-Emitter Voltage	± 20	W
$P_D @ T_C = 25^\circ C$	Maximum Power Dissipation	44	
$P_D @ T_C = 100^\circ C$	Maximum Power Dissipation	22	
T_J	Operating Junction and	-55 to +175	$^\circ C$
T_{STG}	Storage Temperature Range		
	Soldering Temperature for 10 sec.	300 (0.063 in. (1.6mm) from case)	
	Mounting Torque, 6-32 or M3 Screw	10 lbf.in (1.1N.m)	

Thermal / Mechanical Characteristics

	Parameter	Min.	Typ.	Max.	Units
$R_{\theta JC}$	Junction-to-Case- IGBT	—	—	3.4	$^\circ C/W$
$R_{\theta JC}$	Junction-to-Case- Diode	—	—	5.3	
$R_{\theta CS}$	Case-to-Sink, flat, greased surface	—	0.50	—	
$R_{\theta JA}$	Junction-to-Ambient, typical socket mount	—	—	62	
Wt	Weight	—	2.0	—	g



IRGIB10B60KD1PbF

Electrical Characteristics @ $T_J = 25^\circ\text{C}$ (unless otherwise specified)

International
IR Rectifier

	Parameter	Min.	Typ.	Max.	Units	Conditions
$V_{(BR)CES}$	Collector-to-Emitter Breakdown Voltage	600	—	—	V	$V_{GE} = 0V, I_C = 500\mu A$
$\Delta V_{(BR)CES}/\Delta T_J$	Temperature Coeff. of Breakdown Voltage	—	0.99	—	V/ $^\circ\text{C}$	$V_{GE} = 0V, I_C = 1mA (25^\circ\text{C}-150^\circ\text{C})$
$V_{CE(on)}$	Collector-to-Emitter Voltage	1.50	1.70	2.10	V	$I_C = 10A, V_{GE} = 15V, T_J = 25^\circ\text{C}$
		—	2.05	2.35		$I_C = 10A, V_{GE} = 15V, T_J = 150^\circ\text{C}$
		—	2.06	2.35		$I_C = 10A, V_{GE} = 15V, T_J = 175^\circ\text{C}$
$V_{GE(th)}$	Gate Threshold Voltage	3.5	4.5	5.5	V	$V_{CE} = V_{GE}, I_C = 250\mu A$
$\Delta V_{GE(th)}/\Delta T_J$	Threshold Voltage temp. coefficient	—	-10	—	mV/ $^\circ\text{C}$	$V_{CE} = V_{GE}, I_C = 1mA (25^\circ\text{C}-150^\circ\text{C})$
gfe	Forward Transconductance	—	5.0	—	S	$V_{CE} = 50V, I_C = 10A, PW = 80\mu s$
I_{CES}	Zero Gate Voltage Collector Current	—	1.0	150	μA	$V_{GE} = 0V, V_{CE} = 600V$
		—	90	250		$V_{GE} = 0V, V_{CE} = 600V, T_J = 150^\circ\text{C}$
		—	150	400		$V_{GE} = 0V, V_{CE} = 600V, T_J = 175^\circ\text{C}$
V_{FM}	Diode Forward Voltage Drop	—	1.80	2.40	V	$I_F = 5.0A, V_{GE} = 0V$
		—	1.32	1.74		$I_F = 5.0A, V_{GE} = 0V, T_J = 150^\circ\text{C}$
		—	1.23	1.62		$I_F = 5.0A, V_{GE} = 0V, T_J = 175^\circ\text{C}$
I_{GES}	Gate-to-Emitter Leakage Current	—	—	± 100	nA	$V_{GE} = \pm 20V, V_{CE} = 0V$

Switching Characteristics @ $T_J = 25^\circ\text{C}$ (unless otherwise specified)

	Parameter	Min.	Typ.	Max.	Units	Conditions
Q_g	Total Gate Charge (turn-on)	—	41	62	nC	$I_C = 10A$
Q_{ge}	Gate-to-Emitter Charge (turn-on)	—	4.6	6.9		$V_{CC} = 400V$
Q_{gc}	Gate-to-Collector Charge (turn-on)	—	19	29		$V_{GE} = 15V$
E_{on}	Turn-On Switching Loss	—	156	264	μJ	$I_C = 10A, V_{CC} = 400V$
E_{off}	Turn-Off Switching Loss	—	165	273		$V_{GE} = 15V, R_G = 50\Omega, L = 1.07mH$
E_{tot}	Total Switching Loss	—	321	434		$LS = 150nH, T_J = 25^\circ\text{C} \textcircled{1}$
$t_{d(on)}$	Turn-On delay time	—	25	33	ns	$I_C = 10A, V_{CC} = 400V$
t_r	Rise time	—	24	34		$V_{GE} = 15V, R_G = 50\Omega, L = 1.1mH$
$t_{d(off)}$	Turn-Off delay time	—	180	250		$LS = 150nH, T_J = 25^\circ\text{C}$
t_f	Fall time	—	62	87		
E_{on}	Turn-On Switching Loss	—	261	372		$I_C = 10A, V_{CC} = 400V$
E_{off}	Turn-Off Switching Loss	—	313	425	μJ	$V_{GE} = 15V, R_G = 50\Omega, L = 1.07mH$
E_{tot}	Total Switching Loss	—	574	694		$LS = 150nH, T_J = 150^\circ\text{C} \textcircled{2}$
$t_{d(on)}$	Turn-On delay time	—	22	31		$I_C = 8.0A, V_{CC} = 400V$
t_r	Rise time	—	24	34	ns	$V_{GE} = 15V, R_G = 50\Omega, L = 1.07mH$
$t_{d(off)}$	Turn-Off delay time	—	240	340		$LS = 150nH, T_J = 150^\circ\text{C}$
t_f	Fall time	—	48	67		
L_E	Internal Emitter Inductance	—	7.5	—	nH	Measured 5 mm from package
C_{ies}	Input Capacitance	—	610	915	pF	$V_{GE} = 0V$
C_{oes}	Output Capacitance	—	66	99		$V_{CC} = 30V$
C_{res}	Reverse Transfer Capacitance	—	23	35		$f = 1.0MHz$
RBSOA	Reverse Bias Safe Operating Area	FULL SQUARE				$T_J = 150^\circ\text{C}, I_C = 32A, V_p = 600V$ $V_{CC} = 500V, V_{GE} = +15V \text{ to } 0V, R_G = 50\Omega$
SCSOA	Short Circuit Safe Operating Area	10	—	—	μs	$T_J = 150^\circ\text{C}, V_p = 600V, R_G = 50\Omega$ $V_{CC} = 360V, V_{GE} = +15V \text{ to } 0V$
$I_{SC (PEAK)}$	Peak Short Circuit Collector Current	—	100	—	A	
E_{rec}	Reverse Recovery Energy of the Diode	—	99	128	μJ	$T_J = 150^\circ\text{C}$
t_{rr}	Diode Reverse Recovery Time	—	79	103	ns	$V_{CC} = 400V, I_F = 10A, L = 1.07mH$
I_{rr}	Peak Reverse Recovery Current	—	14	18	A	$V_{GE} = 15V, R_G = 50\Omega$
Q_{rr}	Diode Reverse Recovery Charge	—	553	719	nC	$di/dt = 500A/\mu s$

$\textcircled{1} V_{CC} = 80\% (V_{CES}), V_{GE} = 15V, L = 100\mu H, R_G = 50\Omega.$

$\textcircled{2}$ Energy losses include "tail" and diode reverse recovery.

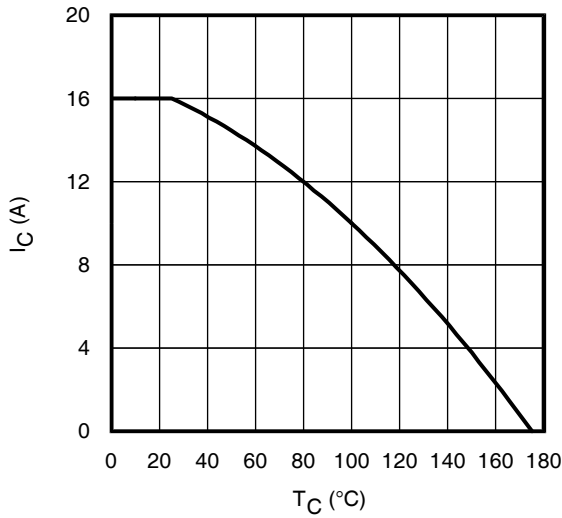

Fig. 1 - Maximum DC Collector Current vs. Case Temperature

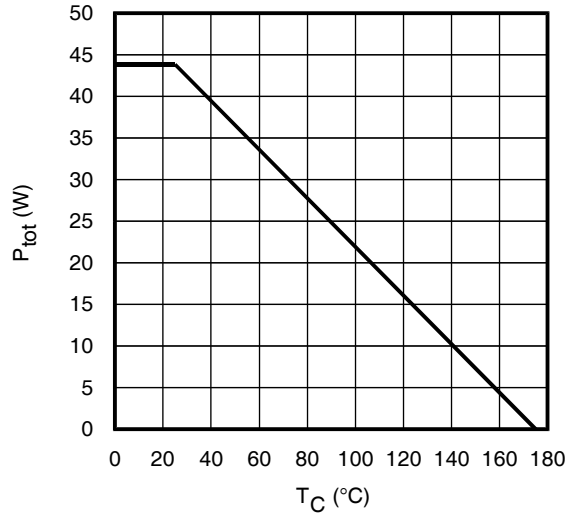

Fig. 2 - Power Dissipation vs. Case Temperature

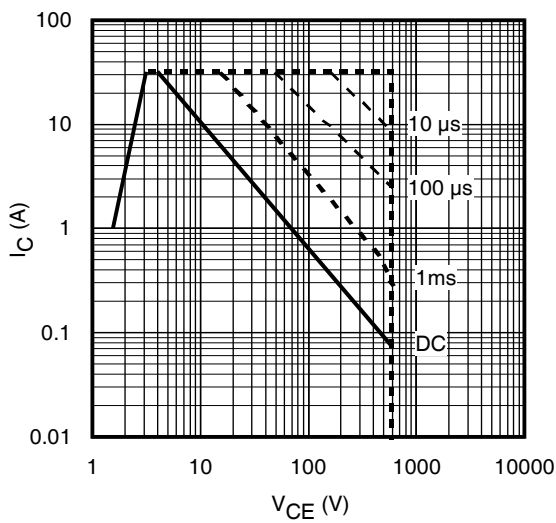

Fig. 3 - Forward SOA
 $T_C = 25^\circ\text{C}$; $T_J \leq 175^\circ\text{C}$

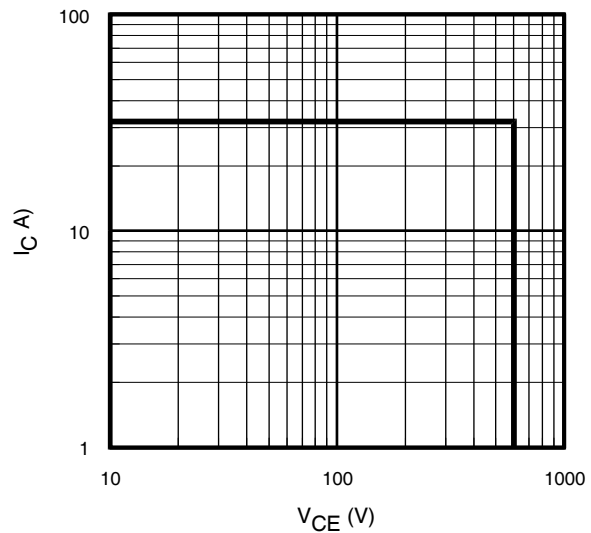

Fig. 4 - Reverse Bias SOA
 $T_J = 150^\circ\text{C}$; $V_{GE} = 15\text{V}$

IRGIB10B60KD1PbF

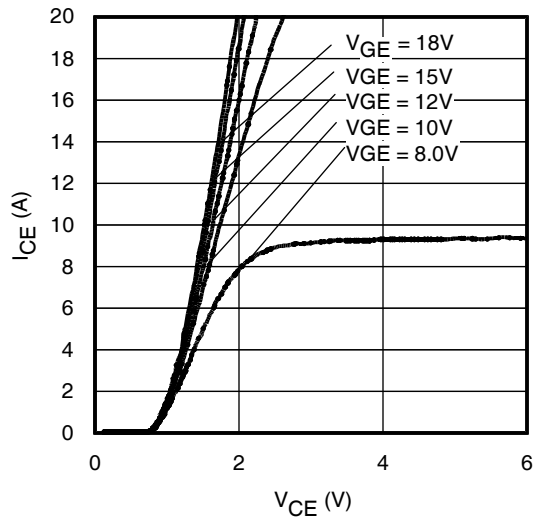

Fig. 5 - Typ. IGBT Output Characteristics
 $T_J = -40^\circ\text{C}$; $t_p = 80\mu\text{s}$

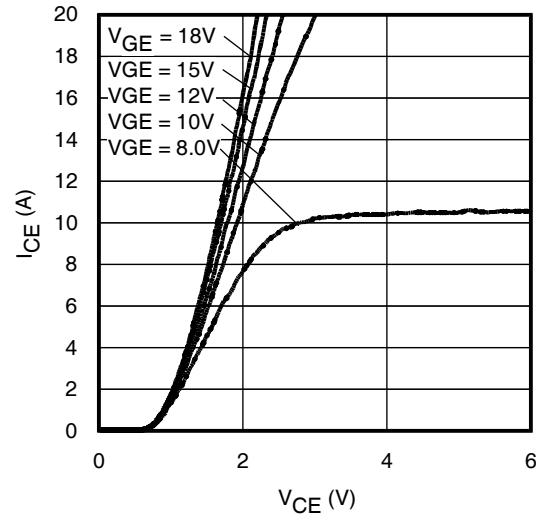

Fig. 6 - Typ. IGBT Output Characteristics
 $T_J = 25^\circ\text{C}$; $t_p = 80\mu\text{s}$

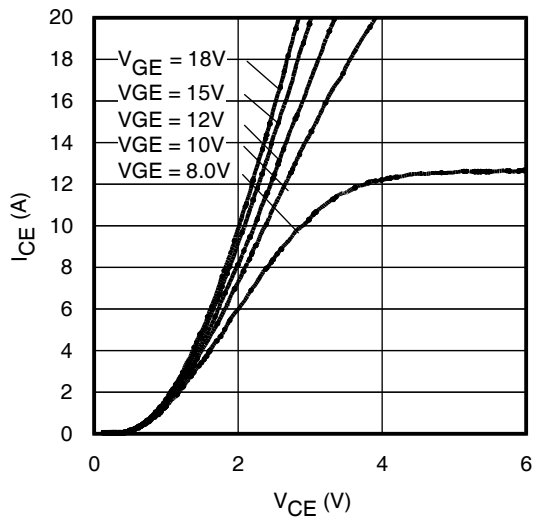

Fig. 7 - Typ. IGBT Output Characteristics
 $T_J = 150^\circ\text{C}$; $t_p = 80\mu\text{s}$

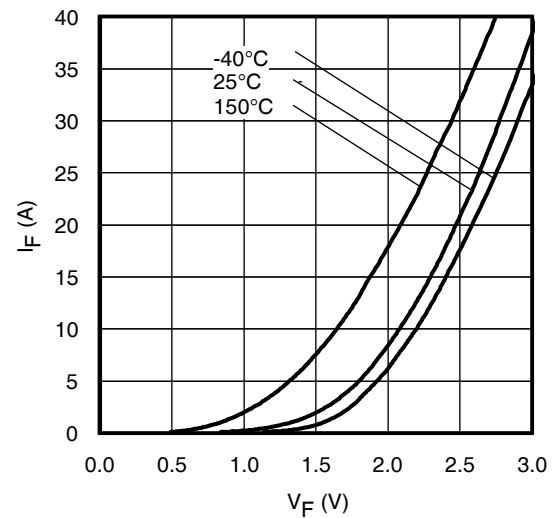

Fig. 8 - Typ. Diode Forward Characteristics
 $t_p = 80\mu\text{s}$

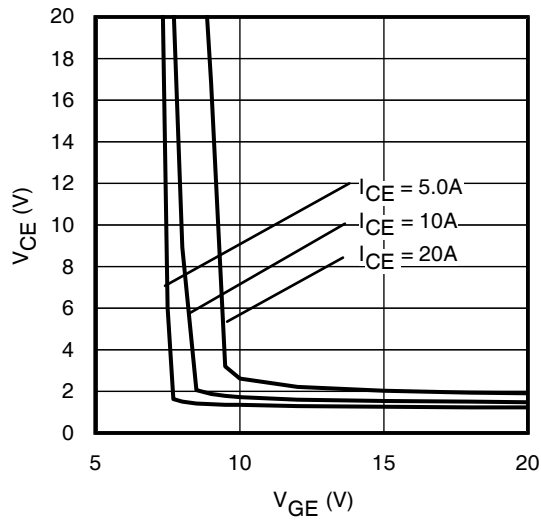

Fig. 9 - Typical V_{CE} vs. V_{GE}
 $T_J = -40^\circ\text{C}$

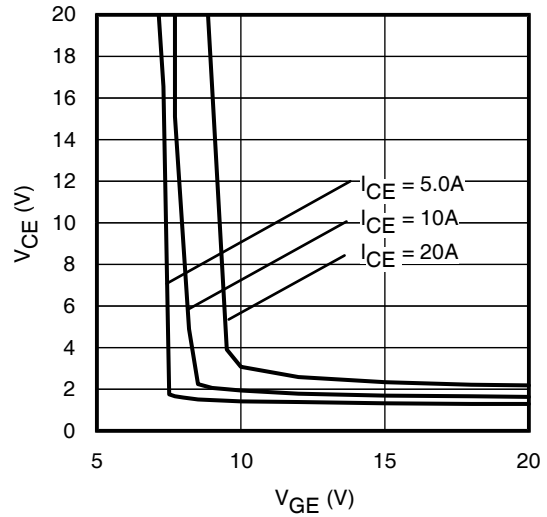

Fig. 10 - Typical V_{CE} vs. V_{GE}
 $T_J = 25^\circ\text{C}$

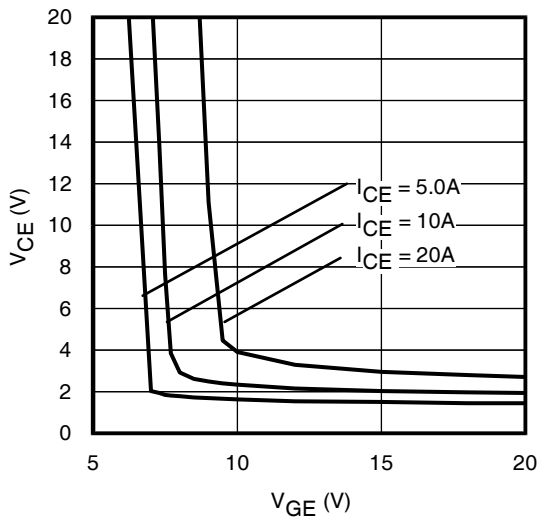

Fig. 11 - Typical V_{CE} vs. V_{GE}
 $T_J = 150^\circ\text{C}$

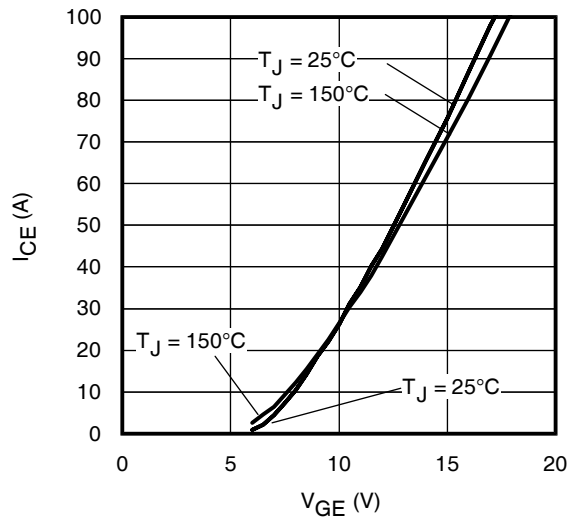

Fig. 12 - Typ. Transfer Characteristics
 $V_{CE} = 50\text{V}$; $t_p = 10\mu\text{s}$

IRGIB10B60KD1PbF

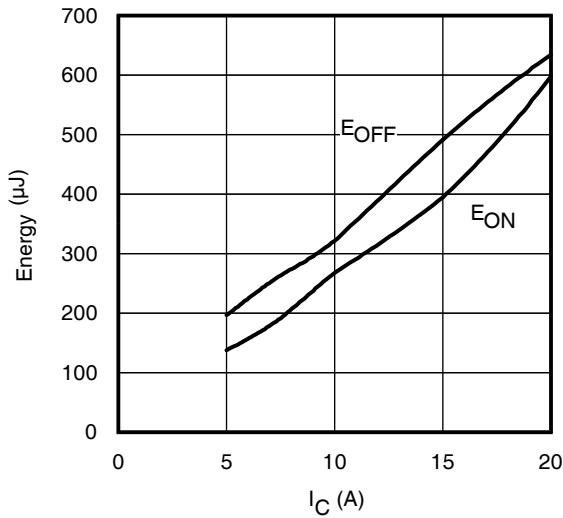

Fig. 13 - Typ. Energy Loss vs. I_C
 $T_J = 150^\circ\text{C}$; $L=1.07\text{mH}$; $V_{CE}= 400\text{V}$
 $R_G= 50\Omega$; $V_{GE}= 15\text{V}$

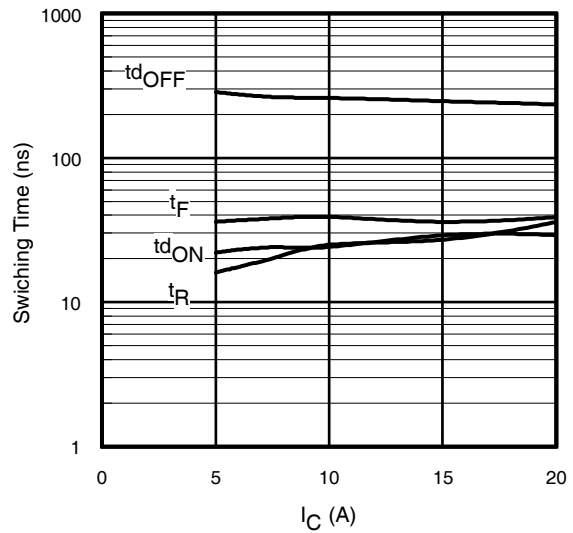

Fig. 14 - Typ. Switching Time vs. I_C
 $T_J = 150^\circ\text{C}$; $L=1.07\text{mH}$; $V_{CE}= 400\text{V}$
 $R_G= 50\Omega$; $V_{GE}= 15\text{V}$

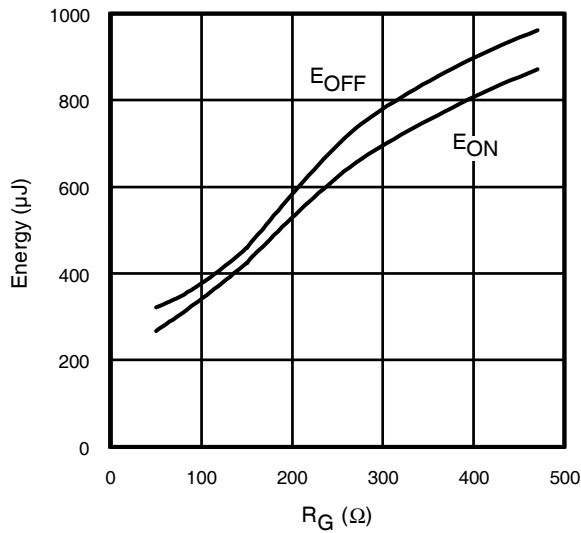

Fig. 15 - Typ. Energy Loss vs. R_G
 $T_J = 150^\circ\text{C}$; $L=1.07\text{mH}$; $V_{CE}= 400\text{V}$
 $I_{CE}= 10\text{A}$; $V_{GE}= 15\text{V}$

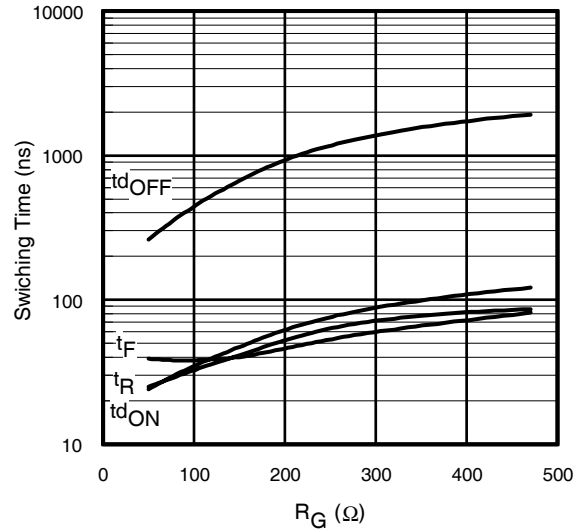

Fig. 16 - Typ. Switching Time vs. R_G
 $T_J = 150^\circ\text{C}$; $L=1.07\text{mH}$; $V_{CE}= 400\text{V}$
 $I_{CE}= 10\text{A}$; $V_{GE}= 15\text{V}$

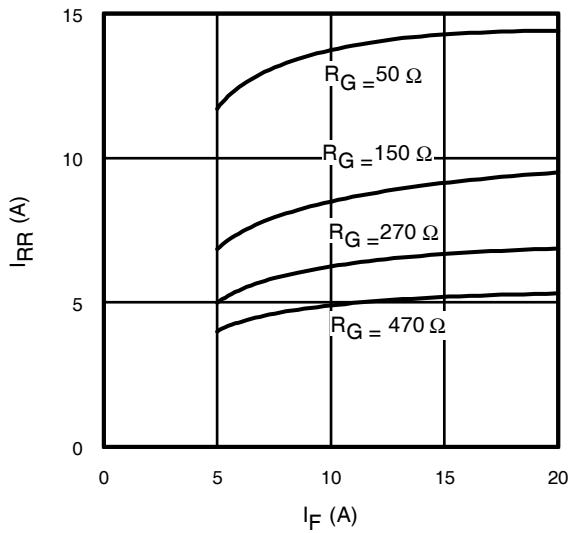

Fig. 17 - Typical Diode I_{RR} vs. I_F
 $T_J = 150^\circ\text{C}$

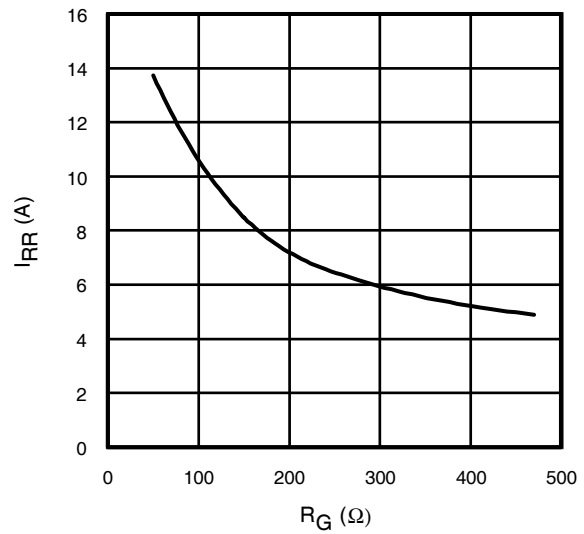

Fig. 18 - Typical Diode I_{RR} vs. R_G
 $T_J = 150^\circ\text{C}; I_F = 10\text{A}$

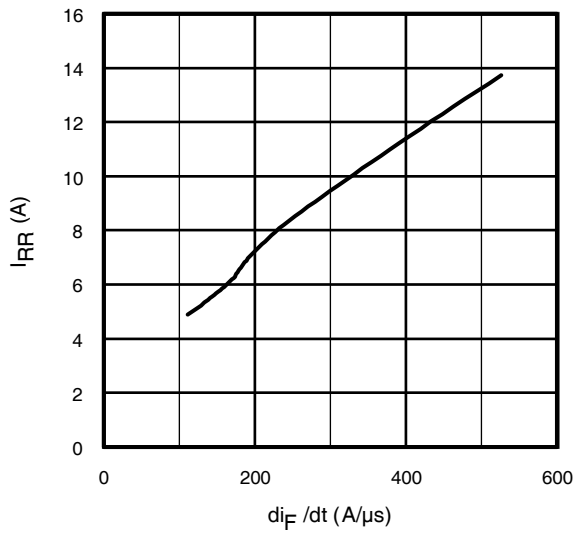

Fig. 19- Typical Diode I_{RR} vs. di_F/dt
 $V_{CC} = 400\text{V}; V_{GE} = 15\text{V};$
 $I_{CE} = 10\text{A}; T_J = 150^\circ\text{C}$

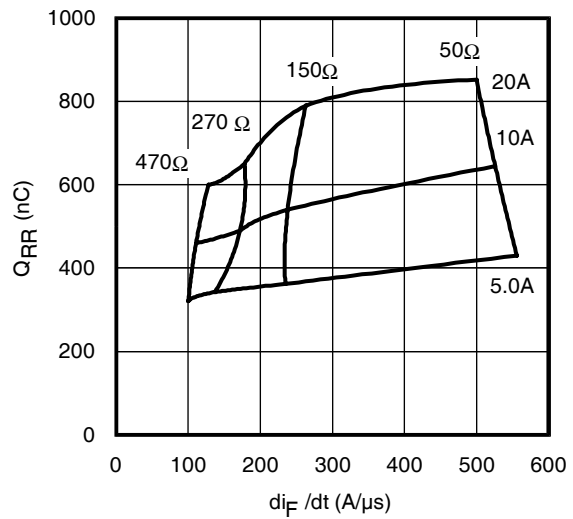

Fig. 20 - Typical Diode Q_{RR}
 $V_{CC} = 400\text{V}; V_{GE} = 15\text{V}; T_J = 150^\circ\text{C}$

IRGIB10B60KD1PbF

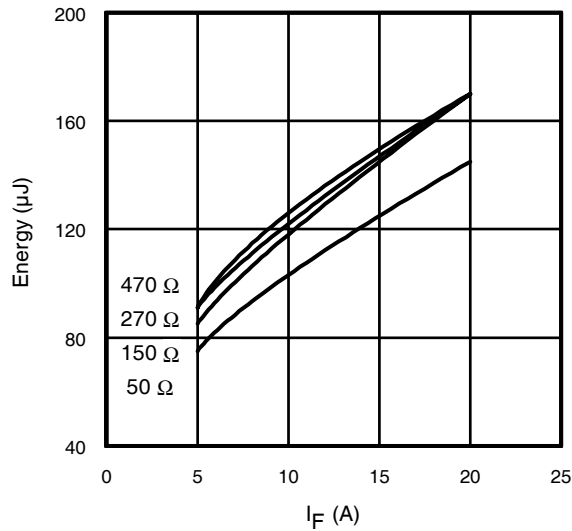

Fig. 21 - Typical Diode E_{RR} vs. I_F
 $T_J = 150^\circ\text{C}$

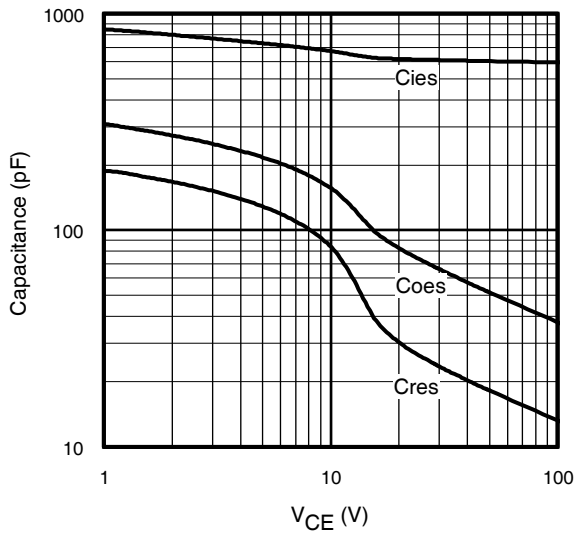

Fig. 22- Typ. Capacitance vs. V_{CE}
 $V_{GE} = 0\text{V}$; $f = 1\text{MHz}$

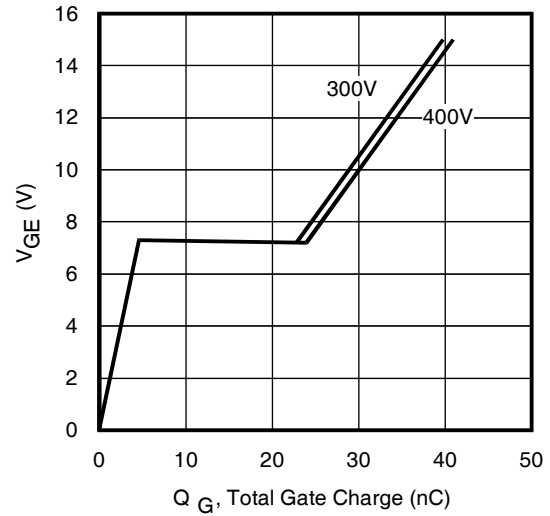

Fig. 23 - Typical Gate Charge vs. V_{GE}
 $I_{CE} = 10\text{A}$; $L = 2500\mu\text{H}$

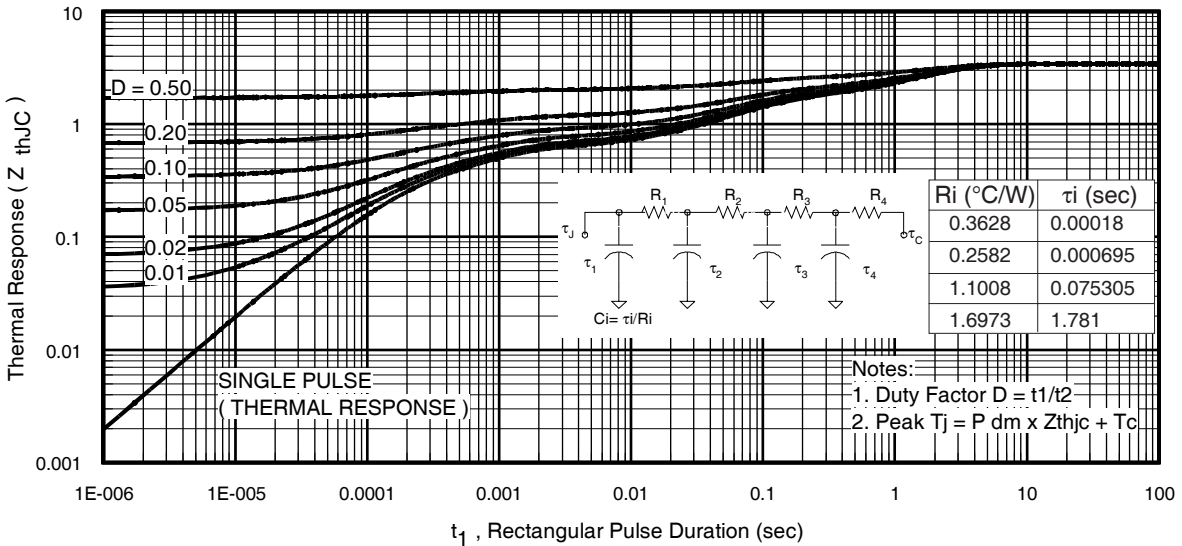

Fig 24. Maximum Transient Thermal Impedance, Junction-to-Case (IGBT)

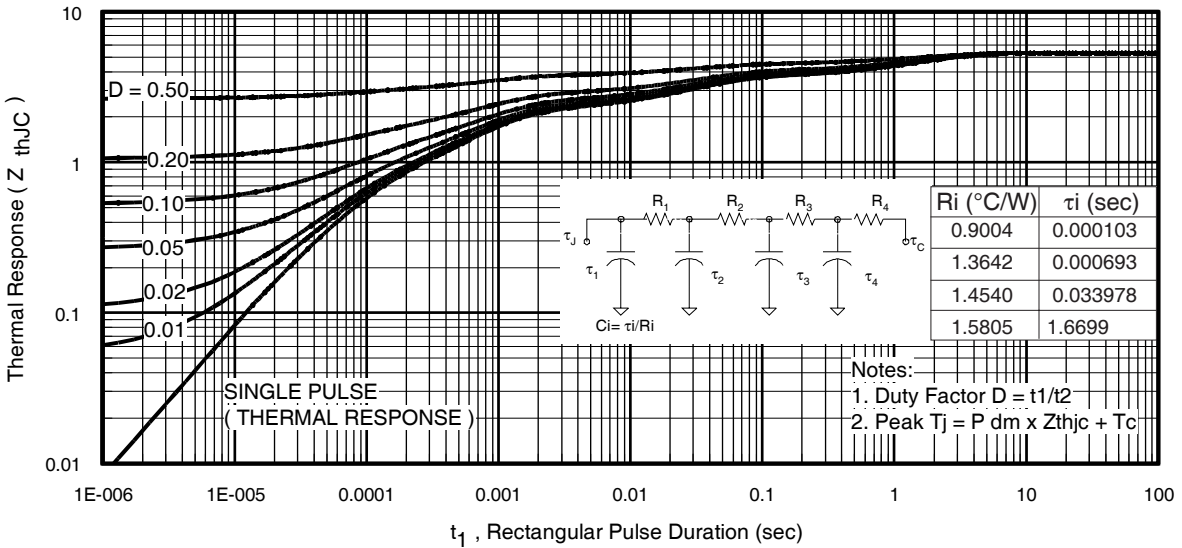

Fig 25. Maximum Transient Thermal Impedance, Junction-to-Case (DIODE)

IRGIB10B60KD1PbF

International
IR Rectifier

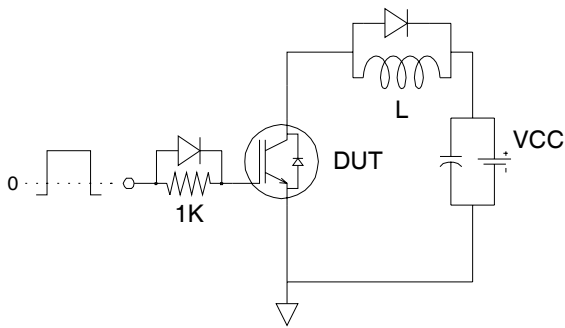

Fig.C.T.1 - Gate Charge Circuit (turn-off)

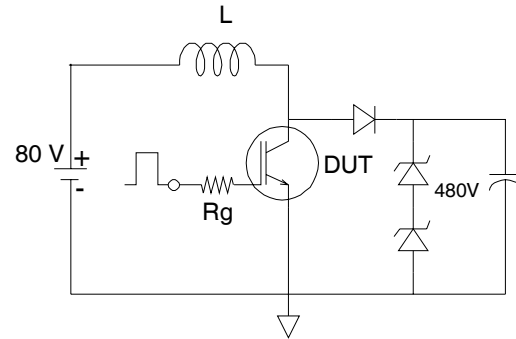

Fig.C.T.2 - RBSOA Circuit

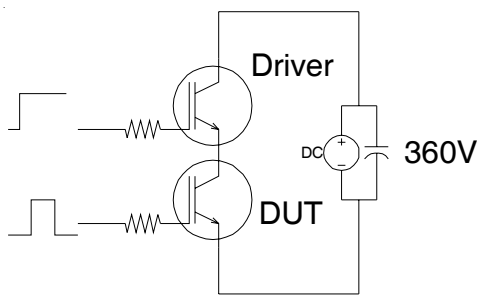

Fig.C.T.3 - S.C.SOA Circuit

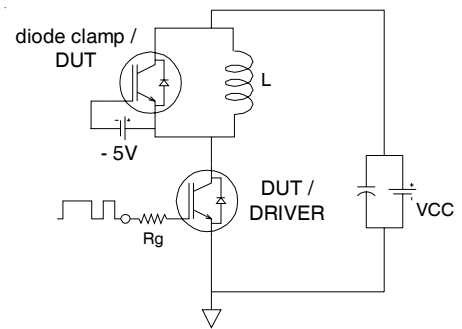

Fig.C.T.4 - Switching Loss Circuit

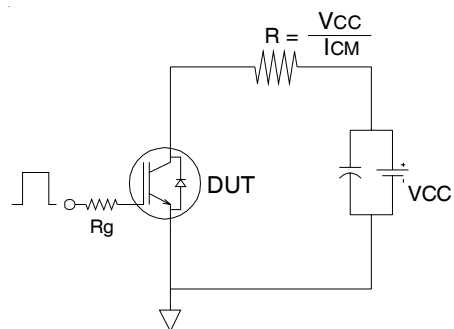

Fig.C.T.5 - Resistive Load Circuit

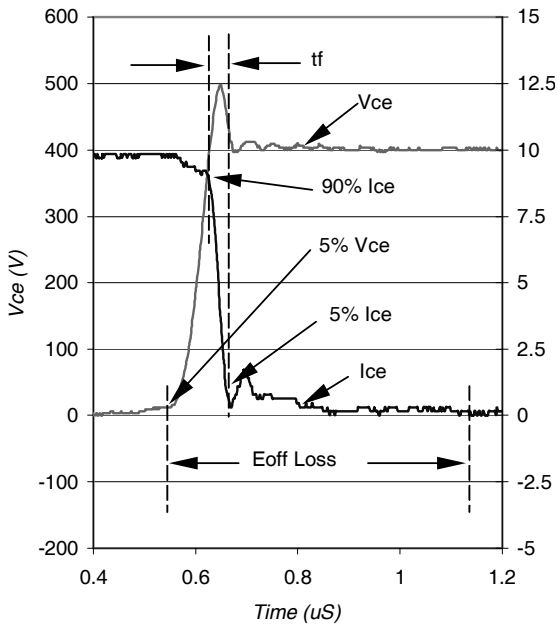

Fig. WF1- Typ. Turn-off Loss Waveform
 @ $T_J = 150^\circ\text{C}$ using Fig. CT.4

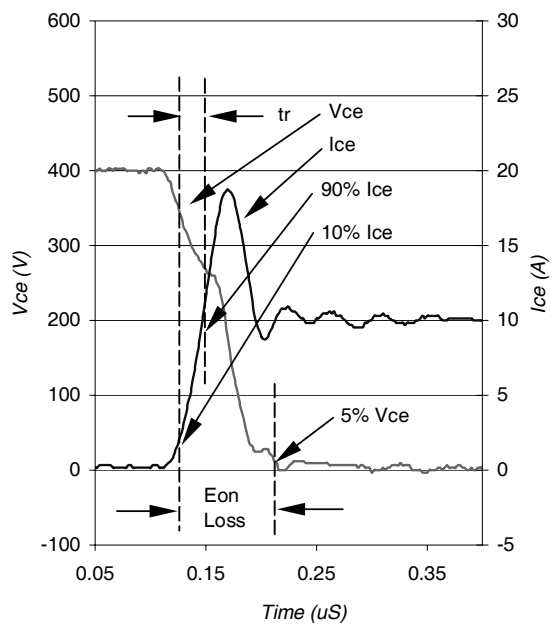

Fig. WF2- Typ. Turn-on Loss Waveform
 @ $T_J = 150^\circ\text{C}$ using Fig. CT.4

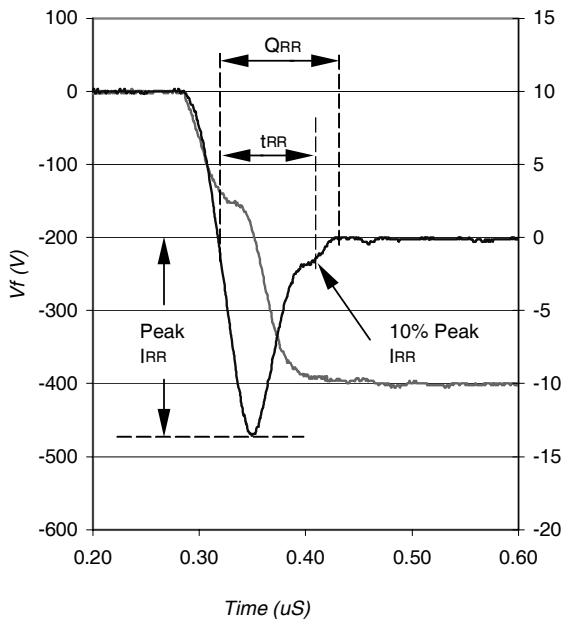

Fig. WF3- Typ. Diode Recovery Waveform
 @ $T_J = 150^\circ\text{C}$ using Fig. CT.4

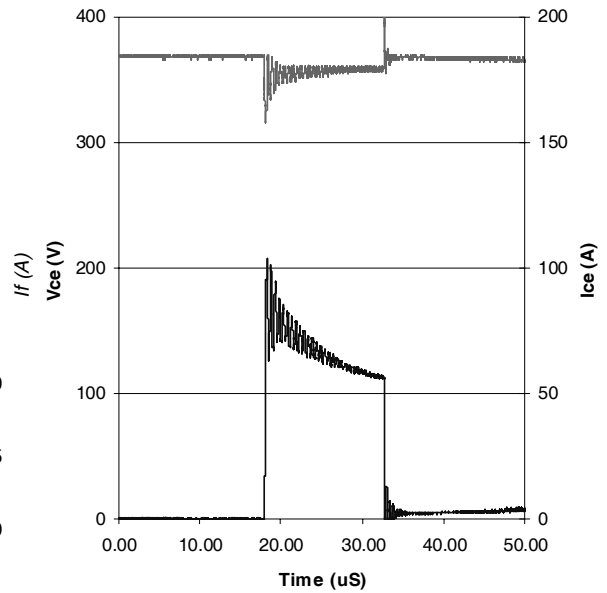

Fig. WF4- Typ. S.C Waveform
 @ $T_C = 150^\circ\text{C}$ using Fig. CT.3

IRGIB10B60KD1PbF



TO-220 Full-Pak Package Outline

Dimensions are shown in millimeters (inches)

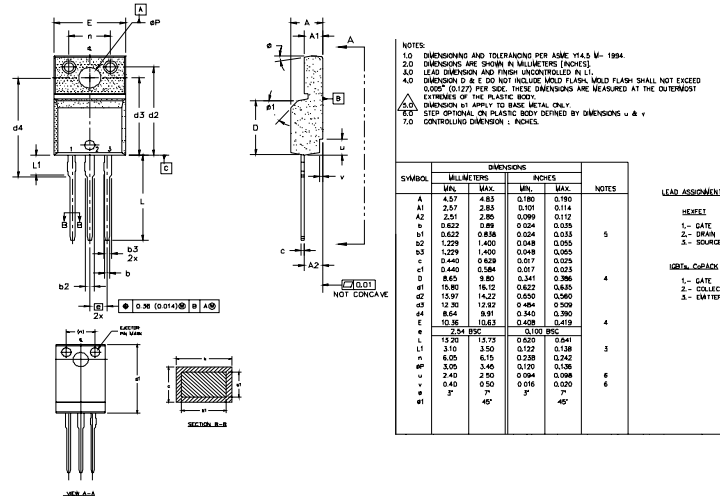

TO-220 Full-Pak Part Marking Information

EXAMPLE: THIS IS AN IRF1840G
 WITH ASSEMBLY
 LOT CODE 3432
 ASSEMBLED ON WW 24 1999
 IN THE ASSEMBLY LINE "K"
Note: "P" in assembly line
 position indicates "Lead-Free"

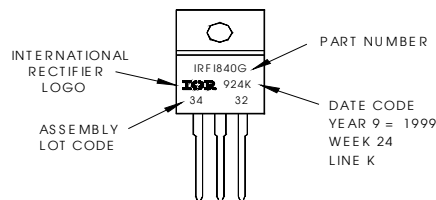

TO-220 Full-Pak package is not recommended for Surface Mount Application

Data and specifications subject to change without notice.
 This product has been designed and qualified for the Industrial market.
 Qualification Standards can be found on IR's Web site.



IR WORLD HEADQUARTERS: 233 Kansas St., El Segundo, California 90245, USA Tel: (310) 252-7105
 TAC Fax: (310) 252-7903

Visit us at www.irf.com for sales contact information.12/03