

International IR Rectifier

PD- 94914

IRGIB15B60KD1P

INSULATED GATE BIPOLAR TRANSISTOR WITH
ULTRAFAST SOFT RECOVERY DIODE

Features

- Low VCE (on) Non Punch Through IGBT Technology.
- Low Diode VF.
- 10µs Short Circuit Capability.
- Square RBSOA.
- Ultrasoft Diode Reverse Recovery Characteristics.
- Positive VCE (on) Temperature Coefficient.
- Maximum Junction Temperature Rated at 175°C
- Lead-Free

Benefits

- Benchmark Efficiency for Motor Control.
- Rugged Transient Performance.
- Low EMI.
- Excellent Current Sharing in Parallel Operation.

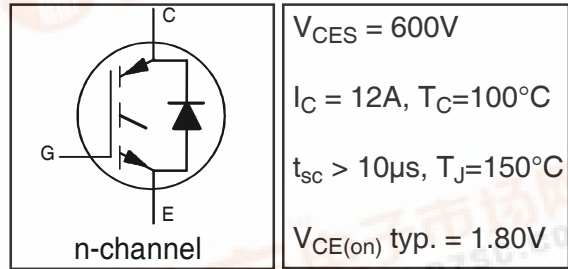

$V_{CES} = 600V$

$I_C = 12A, T_C = 100^\circ C$

$t_{sc} > 10\mu s, T_J = 150^\circ C$

$V_{CE(on)} \text{ typ.} = 1.80V$



TO-220
Full-Pak

Absolute Maximum Ratings

	Parameter	Max.	Units
V_{CES}	Collector-to-Emitter Voltage	600	V
$I_C @ T_C = 25^\circ C$	Continuous Collector Current	19	A
$I_C @ T_C = 100^\circ C$	Continuous Collector Current	12	
I_{CM}	Pulse Collector Current (Ref.Fig.C.T.5)	38	
I_{LM}	Clamped Inductive Load current ①	38	
$I_F @ T_C = 25^\circ C$	Diode Continuous Forward Current	19	
$I_F @ T_C = 100^\circ C$	Diode Continuous Forward Current	12	V
I_{FM}	Diode Maximum Forward Current	38	
V_{ISOL}	RMS Isolation Voltage, Terminal to Case, $t = 1 \text{ min}$	2500	
V_{GE}	Gate-to-Emitter Voltage	± 20	W
$P_D @ T_C = 25^\circ C$	Maximum Power Dissipation	52	
$P_D @ T_C = 100^\circ C$	Maximum Power Dissipation	26	$^\circ C$
T_J	Operating Junction and Storage Temperature Range	-55 to +175	
T_{STG}	Soldering Temperature for 10 sec.	300 (0.063 in. (1.6mm) from case)	
	Mounting Torque, 6-32 or M3 Screw	10 lbf.in (1.1N.m)	

Thermal / Mechanical Characteristics

	Parameter	Min.	Typ.	Max.	Units
$R_{\theta JC}$	Junction-to-Case- IGBT	—	—	2.9	$^\circ C/W$
$R_{\theta JC}$	Junction-to-Case- Diode	—	—	4.6	
$R_{\theta CS}$	Case-to-Sink, flat, greased surface	—	0.50	—	
$R_{\theta JA}$	Junction-to-Ambient, typical socket mount	—	—	62	
Wt	Weight	—	2.0	—	g



IRGIB15B60KD1P

Electrical Characteristics @ T_J = 25°C (unless otherwise specified)

International
IR Rectifier

	Parameter	Min.	Typ.	Max.	Units	Conditions	Ref.Fig.
V _{(BR)CES}	Collector-to-Emitter Breakdown Voltage	600	—	—	V	V _{GE} = 0V, I _C = 500μA	
ΔV _{(BR)CES} /ΔT _J	Temperature Coeff. of Breakdown Voltage	—	0.32	—	V/°C	V _{GE} = 0V, I _C = 1mA (25°C-150°C)	
V _{CE(on)}	Collector-to-Emitter Voltage	—	1.80	2.20	V	I _C = 15A, V _{GE} = 15V, T _J = 25°C	5,6,7
		—	2.05	2.50		I _C = 15A, V _{GE} = 15V, T _J = 150°C	9,10,11
		—	2.10	2.60		I _C = 15A, V _{GE} = 15V, T _J = 175°C	
V _{GE(th)}	Gate Threshold Voltage	3.5	4.5	5.5	V	V _{CE} = V _{GE} , I _C = 250μA	9,10,11
ΔV _{GE(th)} /ΔT _J	Threshold Voltage temp. coefficient	—	-10	—	mV/°C	V _{CE} = V _{GE} , I _C = 1mA (25°C-150°C)	12
g _{fe}	Forward Transconductance	—	10	—	S	V _{CE} = 50V, I _C = 15A, PW = 80μs	
I _{CES}	Zero Gate Voltage Collector Current	—	1.0	150	μA	V _{GE} = 0V, V _{CE} = 600V	
		—	163	500		V _{GE} = 0V, V _{CE} = 600V, T _J = 150°C	
		—	829	1800		V _{GE} = 0V, V _{CE} = 600V, T _J = 175°C	
V _{FM}	Diode Forward Voltage Drop	—	1.69	2.30	V	I _F = 15A, V _{GE} = 0V	8
		—	1.31	1.75		I _F = 15A, V _{GE} = 0V, T _J = 150°C	
		—	1.25	1.65		I _F = 15A, V _{GE} = 0V, T _J = 175°C	
I _{GES}	Gate-to-Emitter Leakage Current	—	—	±100	nA	V _{GE} = ±20V, V _{CE} = 0V	

Switching Characteristics @ T_J = 25°C (unless otherwise specified)

	Parameter	Min.	Typ.	Max.	Units	Conditions	Ref.Fig.
Q _g	Total Gate Charge (turn-on)	—	56	84	nC	I _C = 15A V _{CC} = 400V V _{GE} = 15V	23
Q _{ge}	Gate-to-Emitter Charge (turn-on)	—	7.0	10			CT1
Q _{gc}	Gate-to-Collector Charge (turn-on)	—	26	39			
E _{on}	Turn-On Switching Loss	—	127	140	μJ	I _C = 15A, V _{CC} = 400V V _{GE} = 15V, R _G = 22Ω, L = 1.07mH L _s = 150nH, T _J = 25°C ⊙	CT4
E _{off}	Turn-Off Switching Loss	—	334	422			
E _{tot}	Total Switching Loss	—	461	556			
t _{d(on)}	Turn-On delay time	—	30	39	ns	I _C = 15A, V _{CC} = 400V V _{GE} = 15V, R _G = 22Ω, L = 1.07mH L _s = 150nH, T _J = 25°C	CT4
t _r	Rise time	—	25	35			
t _{d(off)}	Turn-Off delay time	—	173	188			
t _f	Fall time	—	41	53			
E _{on}	Turn-On Switching Loss	—	258	282			
E _{off}	Turn-Off Switching Loss	—	570	646	μJ	I _C = 15A, V _{CC} = 400V V _{GE} = 15V, R _G = 22Ω, L = 1.07mH L _s = 150nH, T _J = 150°C ⊙	13,15
E _{tot}	Total Switching Loss	—	829	915			WF1,WF2
t _{d(on)}	Turn-On delay time	—	30	39			14,16
t _r	Rise time	—	25	35	ns	I _C = 15A, V _{CC} = 400V V _{GE} = 15V, R _G = 22Ω, L = 1.07mH L _s = 150nH, T _J = 150°C	CT4
t _{d(off)}	Turn-Off delay time	—	194	207			WF1
t _f	Fall time	—	56	73			WF2
L _E	Internal Emitter Inductance	—	7.5	—	nH	Measured 5 mm from package	
C _{ies}	Input Capacitance	—	850	1275	pF	V _{GE} = 0V V _{CC} = 30V f = 1.0MHz	22
C _{oes}	Output Capacitance	—	100	150			
C _{res}	Reverse Transfer Capacitance	—	32	48			
RBSOA	Reverse Bias Safe Operating Area	FULL SQUARE				T _J = 150°C, I _C = 38A, V _p = 600V V _{CC} = 500V, V _{GE} = +15V to 0V, R _G = 22Ω	4 CT2
SCSOA	Short Circuit Safe Operating Area	10	—	—	μs	T _J = 150°C, V _p = 600V, R _G = 22Ω V _{CC} = 360V, V _{GE} = +15V to 0V	CT3 WF4
I _{SC (PEAK)}	Peak Short Circuit Collector Current	—	140	—	A		WF4
E _{rec}	Reverse Recovery Energy of the Diode	—	267	347	μJ	T _J = 150°C	17,18,19
t _{rr}	Diode Reverse Recovery Time	—	67	87	ns	V _{CC} = 400V, I _F = 15A, L = 1.07mH	20,21
I _{rr}	Peak Reverse Recovery Current	—	23	30	A	V _{GE} = 15V, R _G = 22Ω	CT4,WF3
Q _{rr}	Diode Reverse Recovery Charge	—	984	1279	nC	di/dt = 875A/μs	

⊙ V_{CC} = 80% (V_{CES}), V_{GE} = 15V, L = 100μH, R_G = 22Ω.

⊙ Energy losses include "tail" and diode reverse recovery.

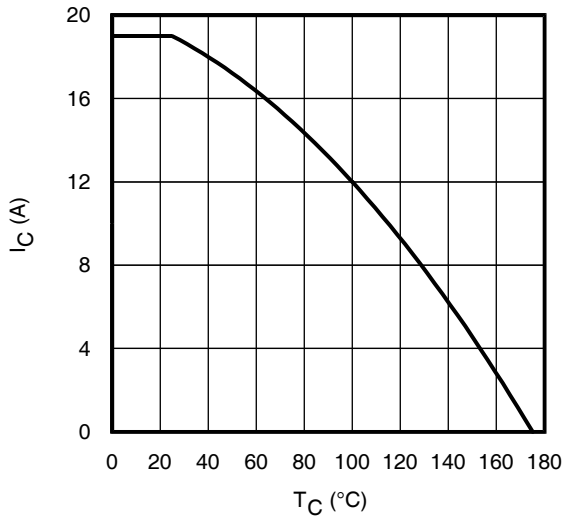

Fig. 1 - Maximum DC Collector Current vs. Case Temperature

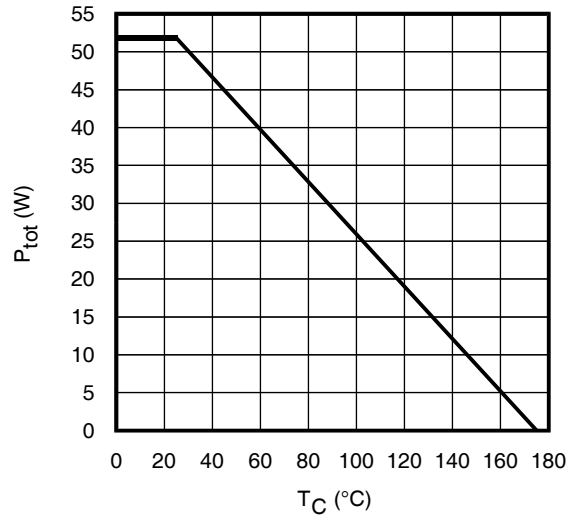

Fig. 2 - Power Dissipation vs. Case Temperature

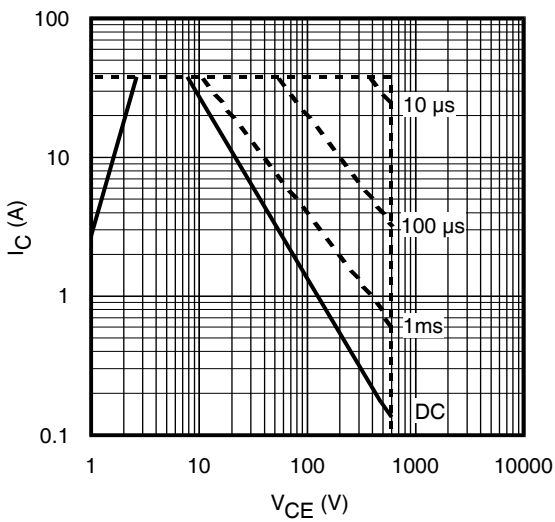

Fig. 3 - Forward SOA
 $T_C = 25^{\circ}\text{C}$; $T_J \leq 150^{\circ}\text{C}$

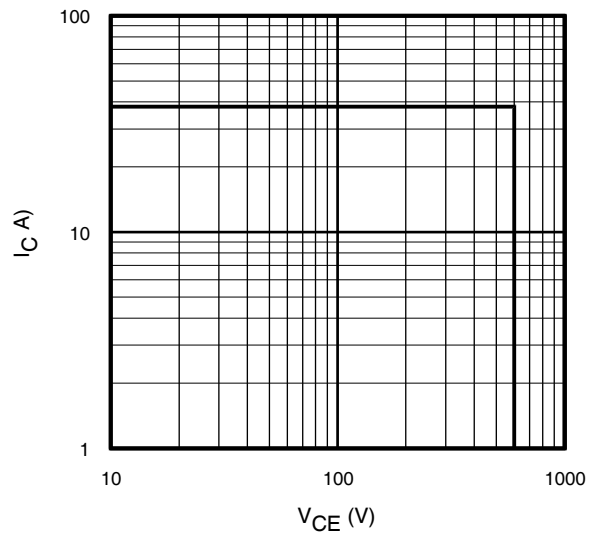

Fig. 4 - Reverse Bias SOA
 $T_J = 150^{\circ}\text{C}$; $V_{GE} = 15\text{V}$

IRGIB15B60KD1P

International
IR Rectifier

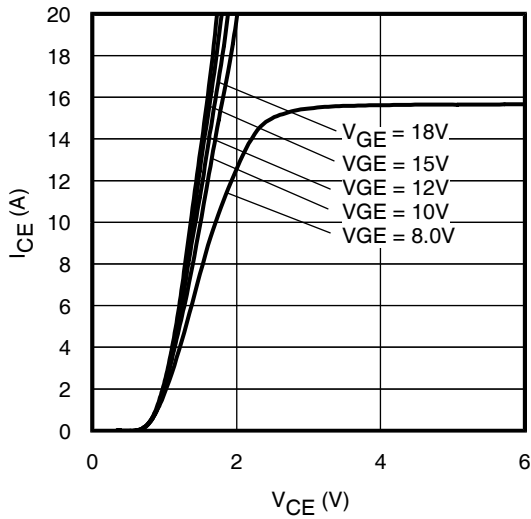

Fig. 5 - Typ. IGBT Output Characteristics
 $T_J = -40^\circ\text{C}$; $t_p = 60\mu\text{s}$

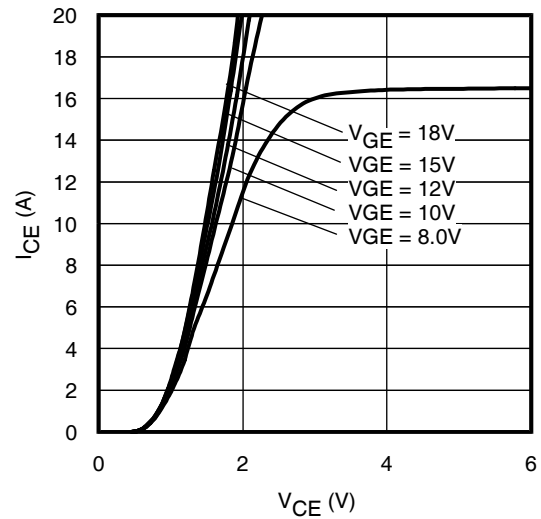

Fig. 6 - Typ. IGBT Output Characteristics
 $T_J = 25^\circ\text{C}$; $t_p = 60\mu\text{s}$

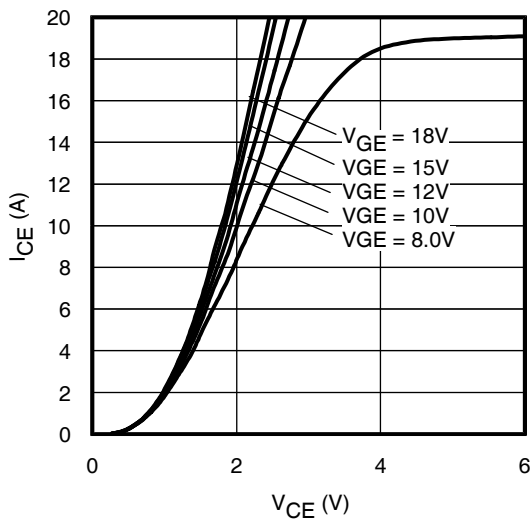

Fig. 7 - Typ. IGBT Output Characteristics
 $T_J = 150^\circ\text{C}$; $t_p = 60\mu\text{s}$

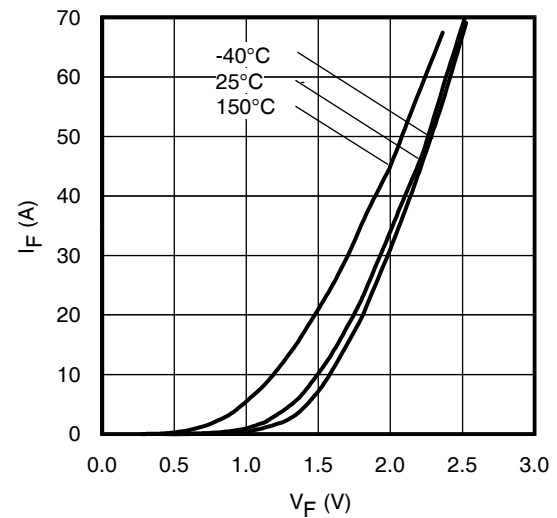

Fig. 8 - Typ. Diode Forward Characteristics
 $t_p = 60\mu\text{s}$

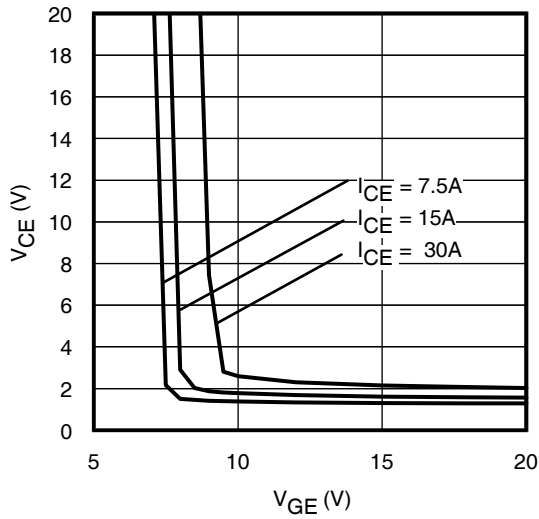

Fig. 9 - Typical V_{CE} vs. V_{GE}
 $T_J = -40^\circ\text{C}$

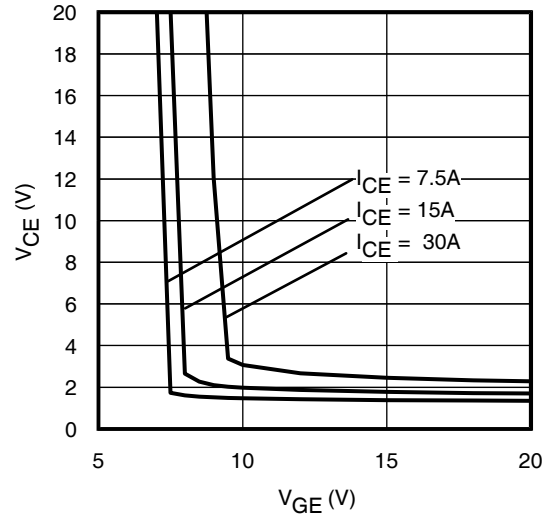

Fig. 10 - Typical V_{CE} vs. V_{GE}
 $T_J = 25^\circ\text{C}$

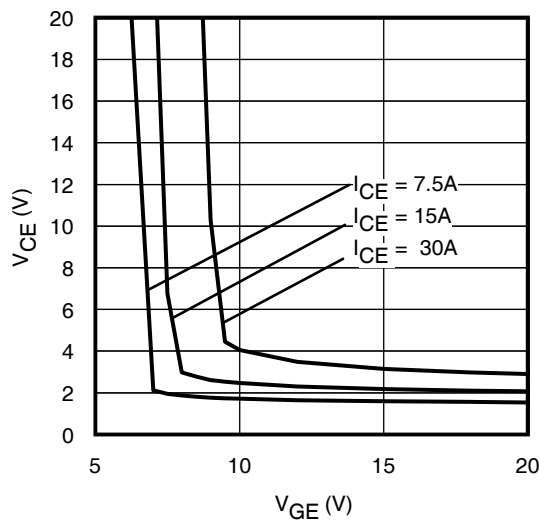

Fig. 11 - Typical V_{CE} vs. V_{GE}
 $T_J = 150^\circ\text{C}$

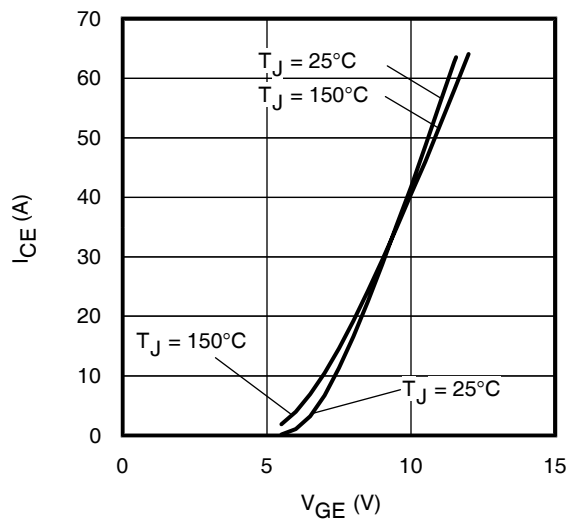

Fig. 12 - Typ. Transfer Characteristics
 $V_{CE} = 50\text{V}$; $t_p = 10\mu\text{s}$

IRGIB15B60KD1P

International
IR Rectifier

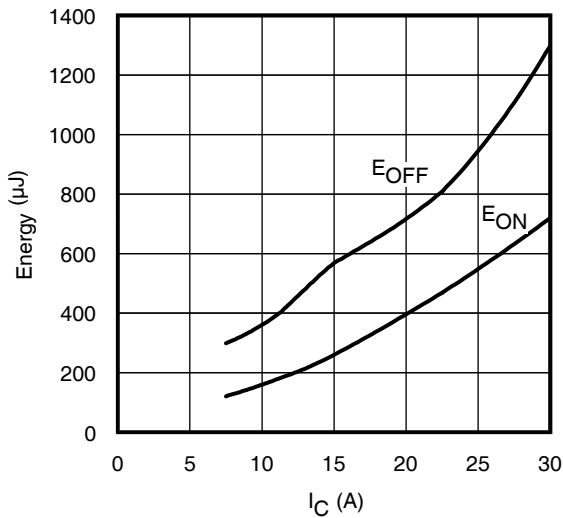

Fig. 13 - Typ. Energy Loss vs. I_C
 $T_J = 150^\circ\text{C}$; $L=1.07\text{mH}$; $V_{CE}= 400\text{V}$
 $R_G= 22\Omega$; $V_{GE}= 15\text{V}$

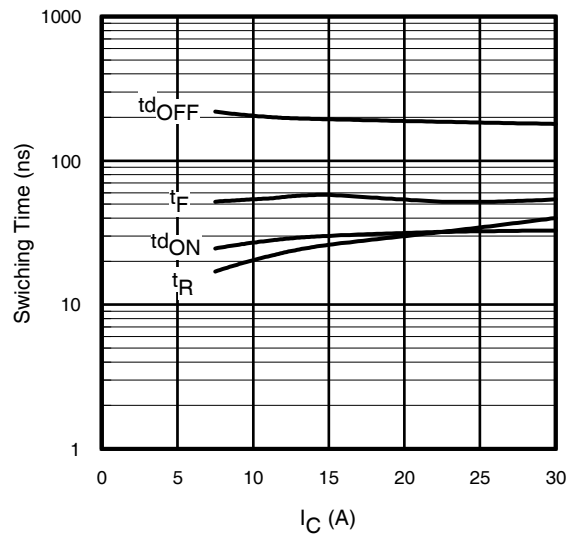

Fig. 14 - Typ. Switching Time vs. I_C
 $T_J = 150^\circ\text{C}$; $L=1.07\text{mH}$; $V_{CE}= 400\text{V}$
 $R_G= 22\Omega$; $V_{GE}= 15\text{V}$

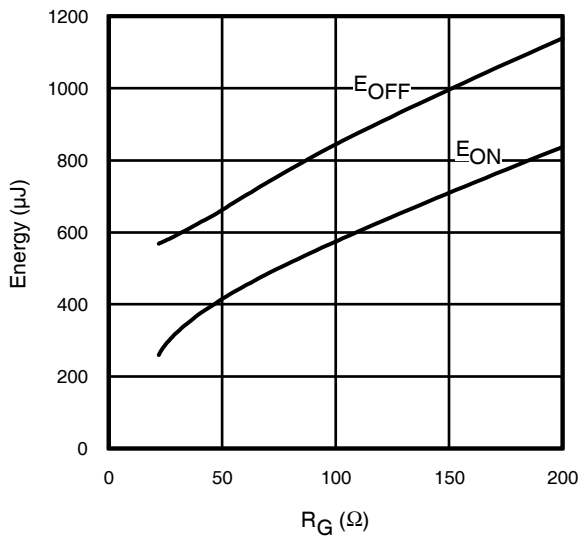

Fig. 15 - Typ. Energy Loss vs. R_G
 $T_J = 150^\circ\text{C}$; $L=1.07\text{mH}$; $V_{CE}= 400\text{V}$
 $I_{CE}= 15\text{A}$; $V_{GE}= 15\text{V}$

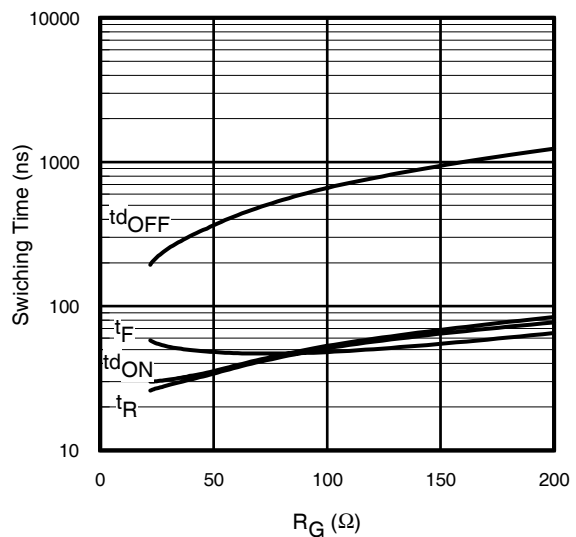

Fig. 16 - Typ. Switching Time vs. R_G
 $T_J = 150^\circ\text{C}$; $L=1.07\text{mH}$; $V_{CE}= 400\text{V}$
 $I_{CE}= 15\text{A}$; $V_{GE}= 15\text{V}$

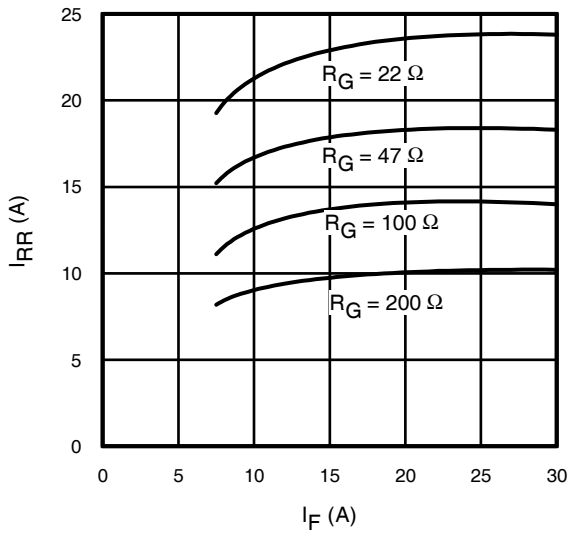

Fig. 17 - Typical Diode I_{RR} vs. I_F
 $T_J = 150^\circ\text{C}$

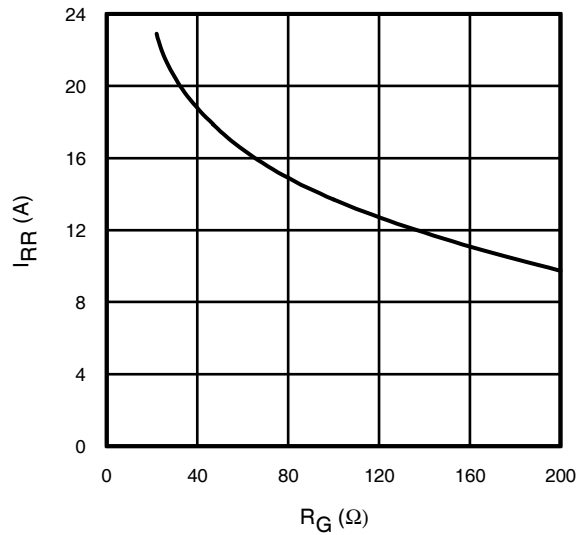

Fig. 18 - Typical Diode I_{RR} vs. R_G
 $T_J = 150^\circ\text{C}$; $I_F = 15\text{A}$

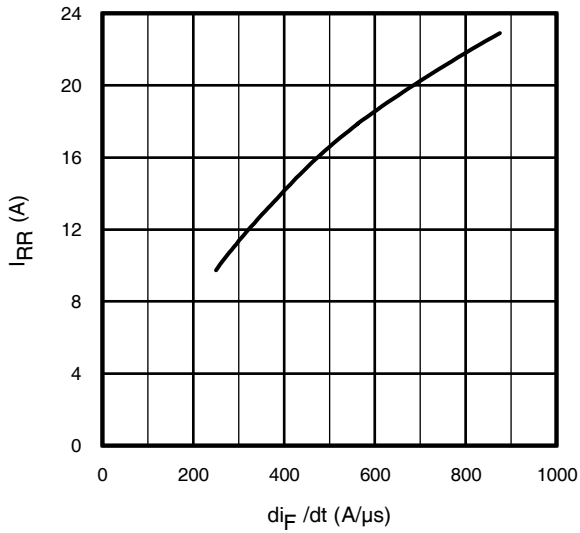

Fig. 19- Typical Diode I_{RR} vs. di_F/dt
 $V_{CC} = 400\text{V}$; $V_{GE} = 15\text{V}$;
 $I_{CE} = 15\text{A}$; $T_J = 150^\circ\text{C}$

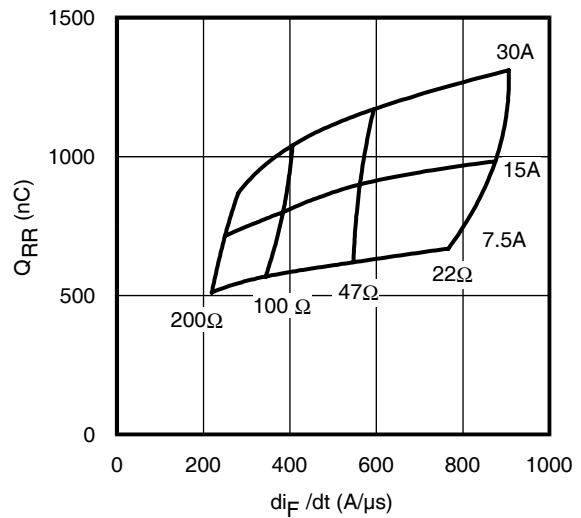

Fig. 20 - Typical Diode Q_{RR}
 $V_{CC} = 400\text{V}$; $V_{GE} = 15\text{V}$; $T_J = 150^\circ\text{C}$

IRGIB15B60KD1P

International
IR Rectifier

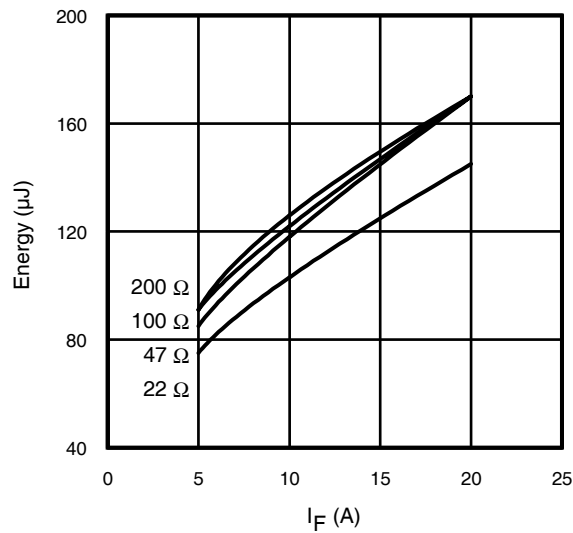

Fig. 21 - Typical Diode E_{RR} vs. I_F
 $T_J = 150^\circ\text{C}$

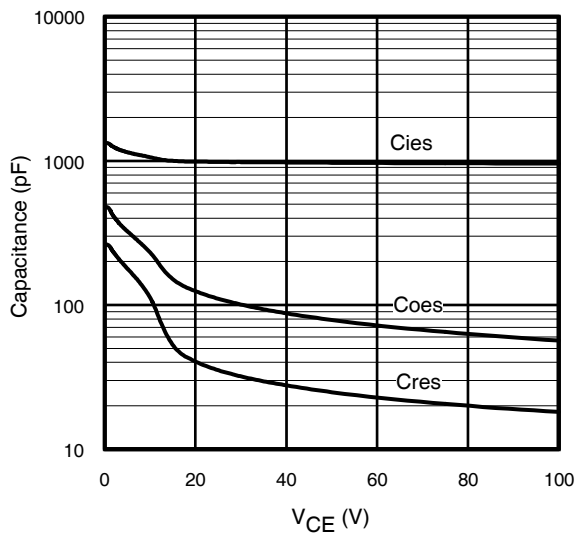

Fig. 22- Typ. Capacitance vs. V_{CE}
 $V_{GE} = 0\text{V}$; $f = 1\text{MHz}$

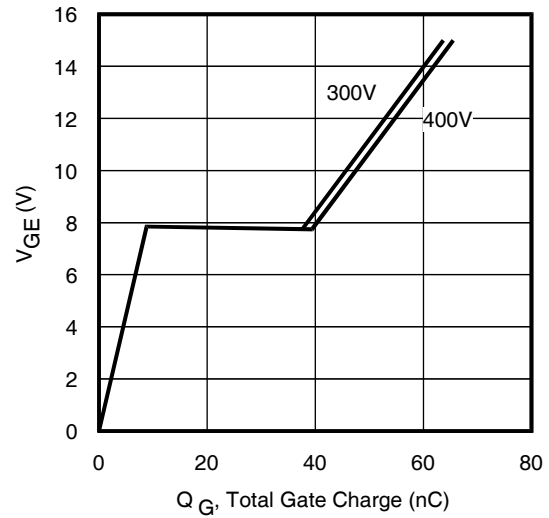

Fig. 23 - Typical Gate Charge vs. V_{GE}
 $I_{CE} = 15\text{A}$; $L = 2500\mu\text{H}$

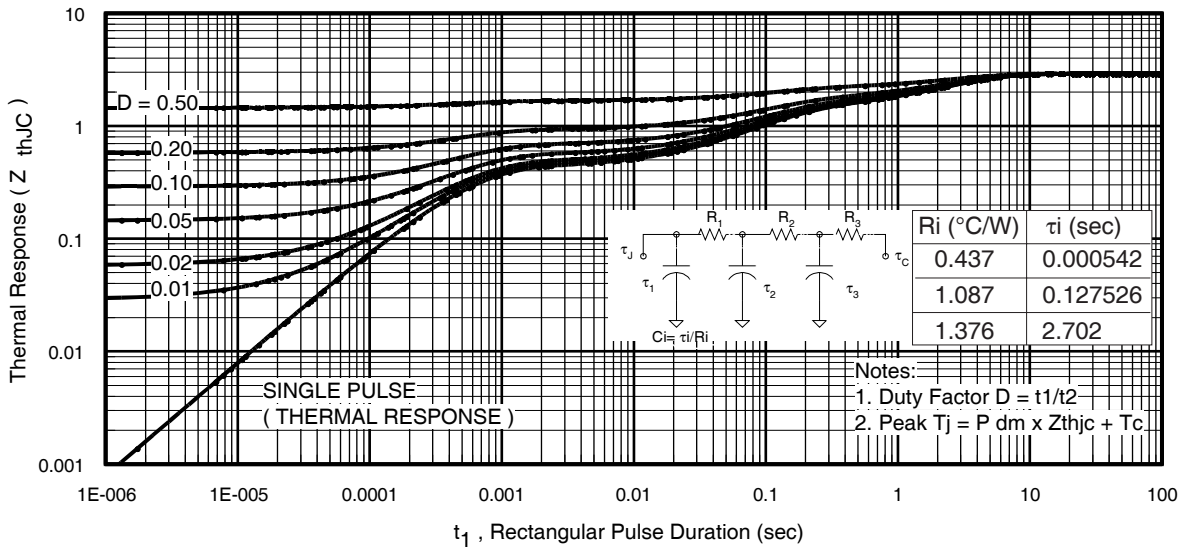

Fig 24. Maximum Transient Thermal Impedance, Junction-to-Case (IGBT)

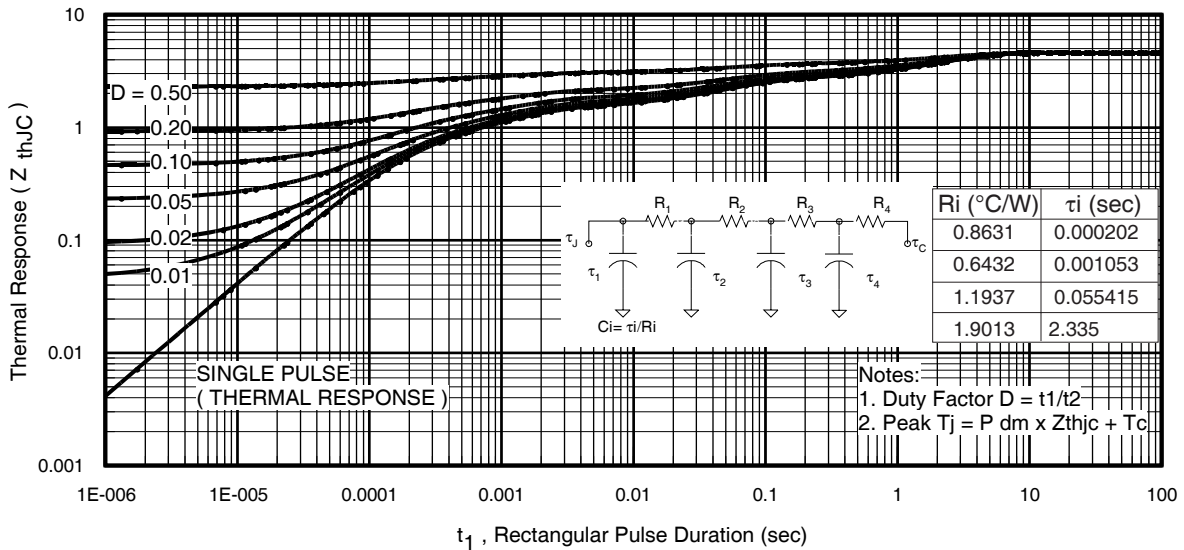

Fig 25. Maximum Transient Thermal Impedance, Junction-to-Case (DIODE)

IRGIB15B60KD1P

International
IR Rectifier

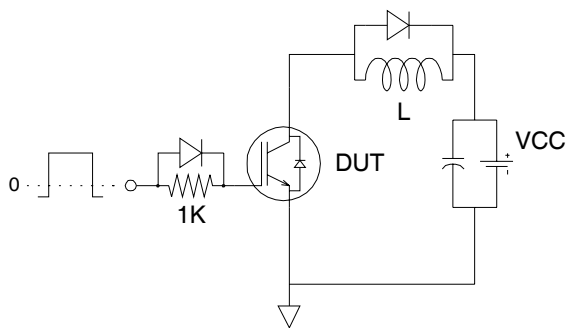

Fig.C.T.1 - Gate Charge Circuit (turn-off)

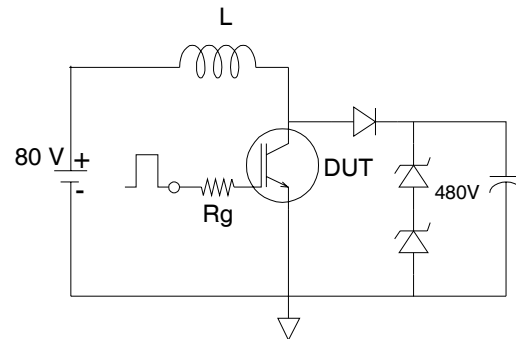

Fig.C.T.2 - RBSOA Circuit

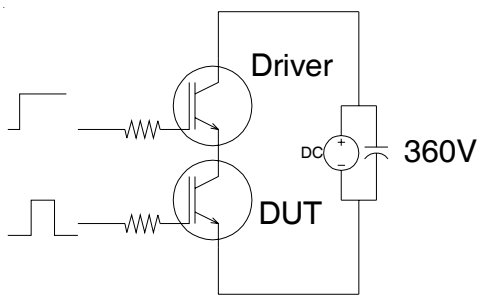

Fig.C.T.3 - S.C.SOA Circuit

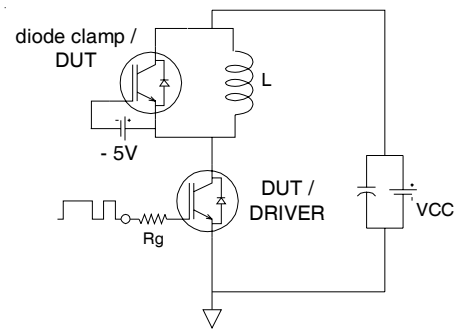

Fig.C.T.4 - Switching Loss Circuit

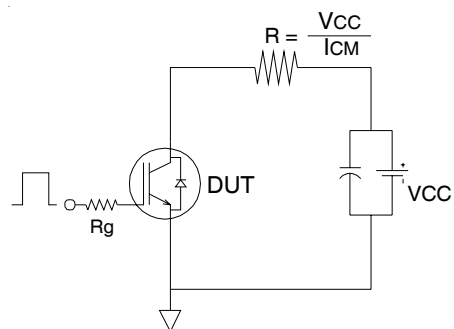

Fig.C.T.5 - Resistive Load Circuit

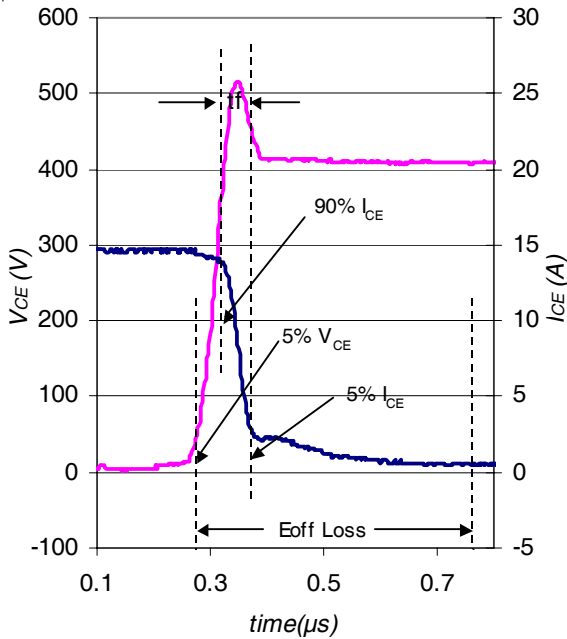

Fig. WF1- Typ. Turn-off Loss Waveform
 @ $T_J = 150^\circ\text{C}$ using Fig. CT.4

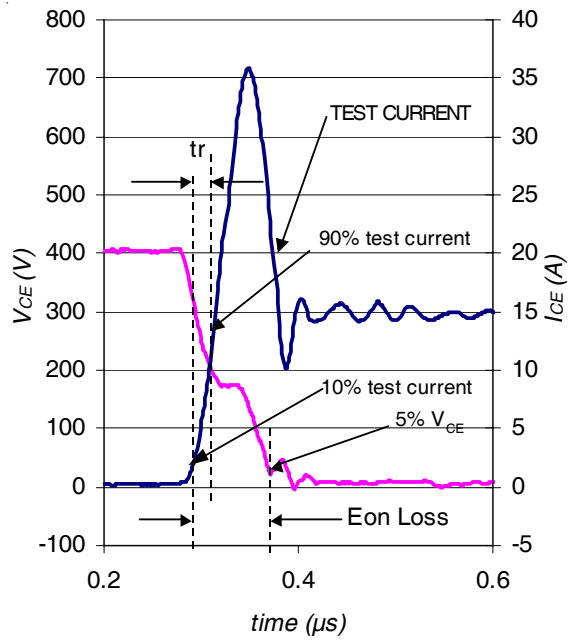

Fig. WF2- Typ. Turn-on Loss Waveform
 @ $T_J = 150^\circ\text{C}$ using Fig. CT.4

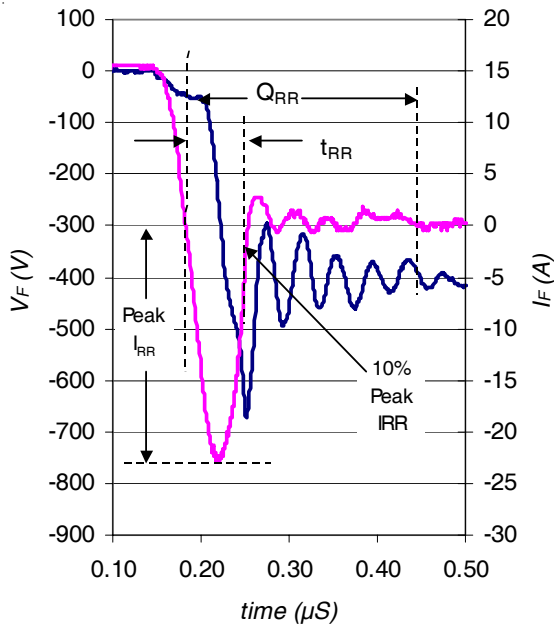

Fig. WF3- Typ. Diode Recovery Waveform
 @ $T_J = 150^\circ\text{C}$ using Fig. CT.4

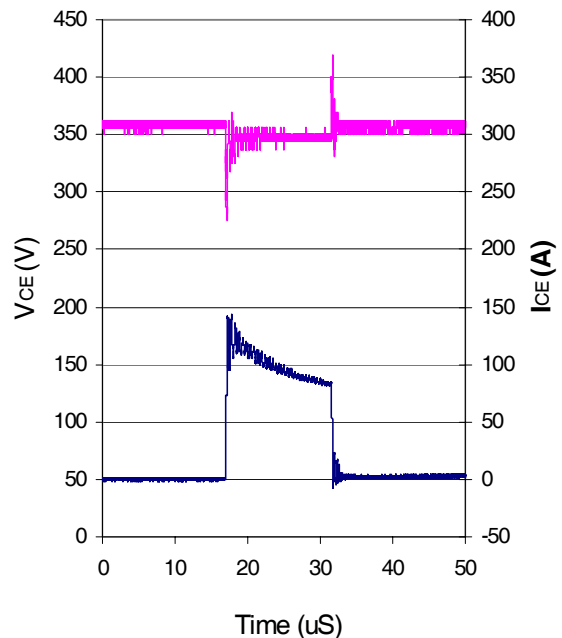

Fig. WF4- Typ. S.C Waveform
 @ $T_C = 150^\circ\text{C}$ using Fig. CT.3

IRGIB15B60KD1P



TO-220 Full-Pak Package Outline

Dimensions are shown in millimeters (inches)

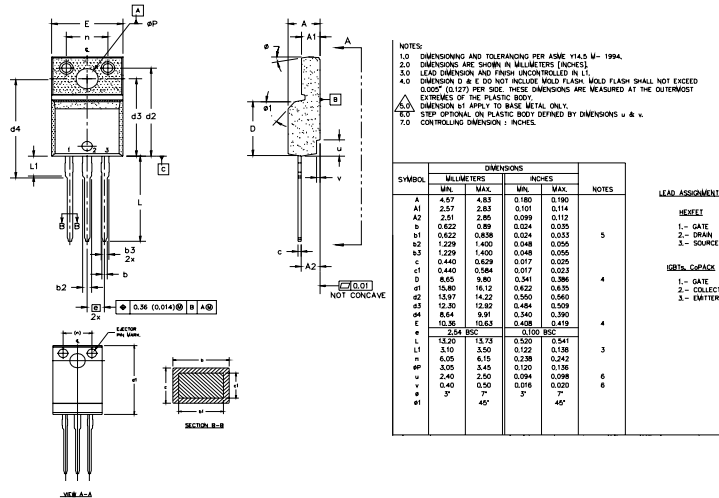

TO-220 Full-Pak Part Marking Information

EXAMPLE: THIS IS AN IRF1840G
 WITH ASSEMBLY
 LOT CODE 3432
 ASSEMBLED ON WW 24 1999
 IN THE ASSEMBLY LINE "K"
Note: "P" in assembly line
 position indicates "Lead-Free"

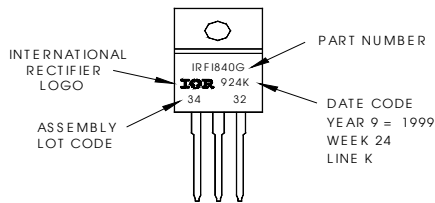

TO-220 FullPak packages are not recommended for Surface Mount Application.

Data and specifications subject to change without notice.
 This product has been designed and qualified for the Industrial market.
 Qualification Standards can be found on IR's Web site.



IR WORLD HEADQUARTERS: 233 Kansas St., El Segundo, California 90245, USA Tel: (310) 252-7105
 TAC Fax: (310) 252-7903

Visit us at www.irf.com for sales contact information.12/03

www.irf.com

Note: For the most current drawings please refer to the IR website at:
<http://www.irf.com/package/>