

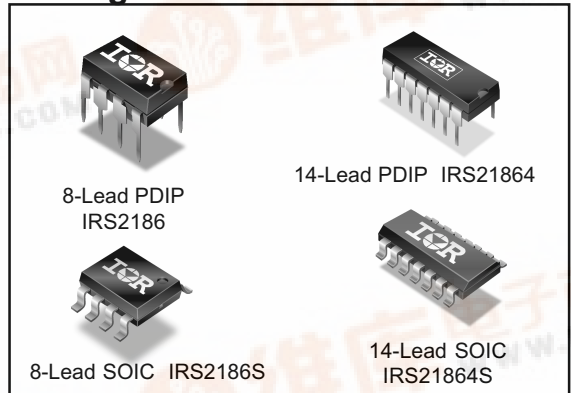
# International IOR Rectifier

## IRS2186/IRS21864(S)PbF HIGH AND LOW SIDE DRIVER

### Features

- Floating channel designed for bootstrap operation
- Fully operational to +600 V
- Tolerant to negative transient voltage, dV/dt immune
- Gate drive supply range from 10 V to 20 V
- Undervoltage lockout for both channels
- 3.3 V and 5 V input logic compatible
- Matched propagation delay for both channels
- Logic and power ground +/- 5V offset.
- Lower di/dt gate driver for better noise immunity
- Output source/sink current capability 4 A/4 A

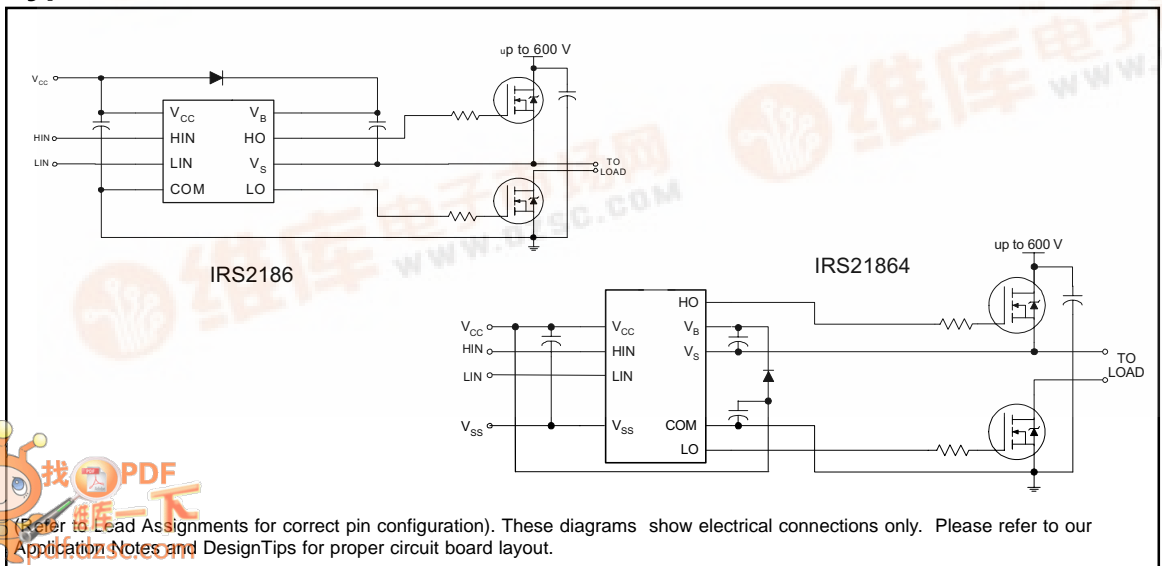
### Packages



### Description

The IRS2186/IRS21864 are high voltage, high speed power MOSFET and IGBT drivers with independent high and low side referenced output channels. Proprietary HVIC and latch immune CMOS technologies enable ruggedized monolithic construction. The logic input is compatible with standard CMOS or LSTTL output, down to 3.3 V logic. The output drivers feature a high pulse current buffer stage designed for minimum driver cross-conduction. The floating channel can be used to drive an N-channel power MOSFET or IGBT in the high side configuration which operates up to 600 V.

### Typical Connection



## Absolute Maximum Ratings

Absolute maximum ratings indicate sustained limits beyond which damage to the device may occur. All voltage parameters are absolute voltages referenced to COM. The thermal resistance and power dissipation ratings are measured under board mounted and still air conditions.

Symbol	Definition	Min.	Max.	Unit	
V <sub>B</sub>	High side floating absolute voltage	-0.3	620 (Note 1)	V	
V <sub>S</sub>	High side floating supply offset voltage	V <sub>B</sub> - 20	V <sub>B</sub> + 0.3	V	
V <sub>HO</sub>	High side floating output voltage	V <sub>S</sub> - 0.3	V <sub>B</sub> + 0.3	V	
V <sub>CC</sub>	Low side and logic fixed supply voltage	-0.3	20 (Note 1)	V	
V <sub>LO</sub>	Low side output voltage	-0.3	V <sub>CC</sub> + 0.3	V	
V <sub>IN</sub>	Logic input voltage (HIN & LIN - IRS2186/IRS21864)	V <sub>SS</sub> - 0.3	V <sub>CC</sub> + 0.3	V	
V <sub>SS</sub>	Logic ground (IRS21864 only)	V <sub>CC</sub> - 20	V <sub>CC</sub> + 0.3	V	
dV <sub>S</sub> /dt	Allowable offset supply voltage transient	—	50	V/n	
P <sub>D</sub>	Package power dissipation @ T <sub>A</sub> ≤ +25 °C	(8-lead PDIP)	—	1.0	W
		(8-lead SOIC)	—	0.625	W
		(14-lead PDIP)	—	1.6	W
		(14-lead SOIC)	—	1.0	W
R <sub>thJA</sub>	Thermal resistance, junction to ambient	(8-lead PDIP)	—	125	°C/W
		(8-lead SOIC)	—	200	°C/W
		(14-lead PDIP)	—	75	°C/W
		(14-lead SOIC)	—	120	°C/W
T <sub>J</sub>	Junction temperature	—	150	°C	
T <sub>S</sub>	Storage temperature	-50	150	°C	
T <sub>L</sub>	Lead temperature (soldering, 10 seconds)	—	300	°C	

Note 1: All supplies are fully tested at 25 V and an internal 20 V clamp exists for each supply.

## Recommended Operating Conditions

The Input/Output logic timing diagram is shown in Fig. 1. For proper operation the device should be used within the recommended conditions. The V<sub>S</sub> and V<sub>SS</sub> offset rating are tested with all supplies biased at a 15 V differential.

Symbol	Definition	Min.	Max.	Unit
V <sub>B</sub>	High side floating supply absolute voltage	V <sub>S</sub> + 10	V <sub>S</sub> + 20	V
V <sub>S</sub>	High side floating supply offset voltage	Note 2	600	V
V <sub>HO</sub>	High side floating output voltage	V <sub>S</sub>	V <sub>B</sub>	V
V <sub>CC</sub>	Low side and logic fixed supply voltage	10	20	V
V <sub>LO</sub>	Low side output voltage	0	V <sub>CC</sub>	V
V <sub>IN</sub>	Logic input voltage HIN & LIN	V <sub>SS</sub>	V <sub>CC</sub>	V
V <sub>SS</sub>	Logic ground (IRS21864 only)	-5	5	V
T <sub>A</sub>	Ambient temperature	-40	125	°C

Note 2: Logic operational for V<sub>S</sub> of -5 V to +600 V. Logic state held for V<sub>S</sub> of -5 V to -V<sub>B</sub>. (Please refer to the Design Note DT97-3 for more details).

## Dynamic Electrical Characteristics

$V_{BIAS}$  ( $V_{CC}$ ,  $V_{BS}$ ) = 15 V,  $V_{SS}$  = COM,  $C_L$  = 1000 pF,  $T_A$  = 25 °C.

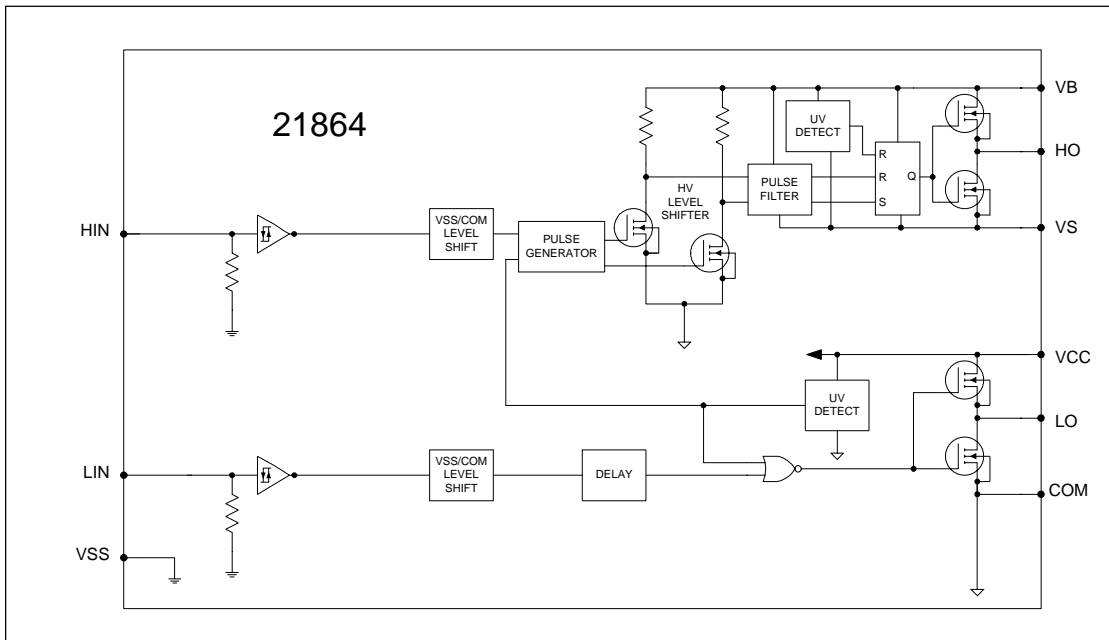
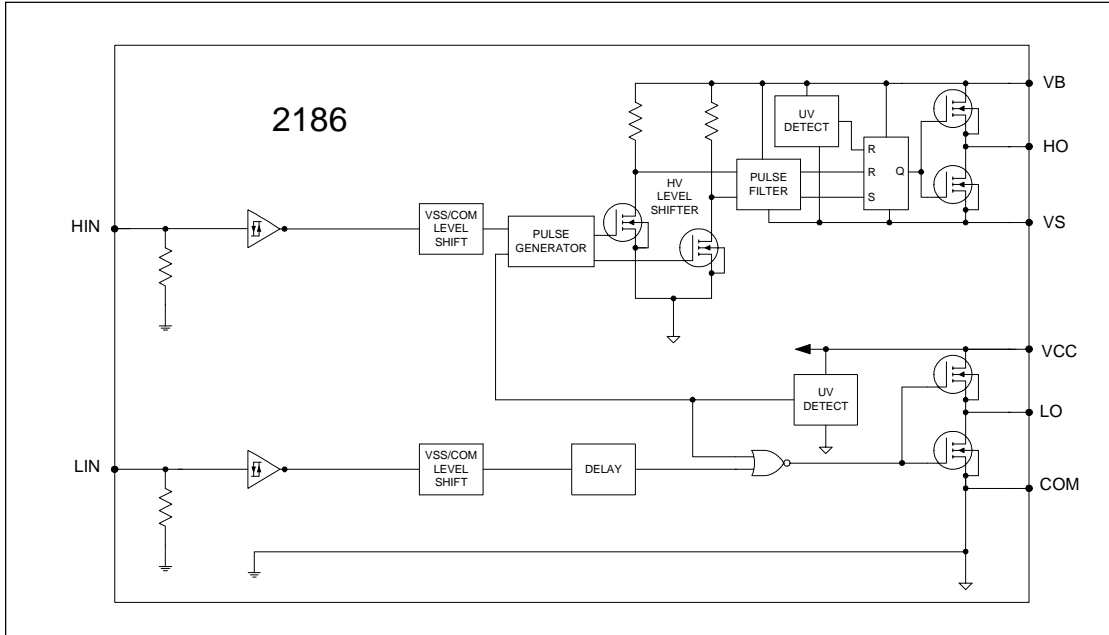
Symbol	Definition	Min.	Typ.	Max.	Units	Test Conditions
$t_{on}$	Turn-on propagation delay	—	170	250	ns	$V_S = 0$ V
$t_{off}$	Turn-off propagation delay	—	170	250		$V_S = 0$ V or 60 V
MT	Delay matching, HS & LS turn-on/off	—	0	35		
$t_r$	Turn-on rise time	—	22	38		
$t_f$	Turn-off fall time	—	18	30		$V_S = 0$ V

## Static Electrical Characteristics

$V_{BIAS}$  ( $V_{CC}$ ,  $V_{BS}$ ) = 15 V,  $V_{SS}$  = COM and  $T_A$  = 25 °C unless otherwise specified. The  $V_{IL}$ ,  $V_{IH}$ , and  $I_{IN}$  parameters are referenced to  $V_{SS}/COM$  and are applicable to the respective input leads HIN and LIN. The  $V_O$ ,  $I_O$ , and  $R_{on}$  parameters are referenced to COM and are applicable to the respective output leads: HO and LO.

Symbol	Definition	Min.	Typ.	Max.	Units	Test Conditions
$V_{IH}$	Logic "1" input voltage	2.5	—	—	V	$V_{CC} = 10$ V to 20 V
$V_{IL}$	Logic "0" input voltage	—	—	0.8		$I_O = 0$ A
$V_{OH}$	High level output voltage, $V_{BIAS} - V_O$	—	—	1.2		$I_O = 20$ mA
$V_{OL}$	Low level output voltage, $V_O$	—	—	0.15		$V_B = V_S = 200$ V
$I_{LK}$	Offset supply leakage current	—	—	50	$\mu$ A	$V_{IN} = 0$ V or 5 V
$I_{QBS}$	Quiescent $V_{BS}$ supply current	20	60	150		$V_{IN} = 5$ V
$I_{QCC}$	Quiescent $V_{CC}$ supply current	50	120	240		$V_{IN} = 0$ V
$I_{IN+}$	Logic "1" input bias current	—	25	60		
$I_{IN-}$	Logic "0" input bias current	—	—	1.0		
$V_{CCUV+}$ $V_{BSUV+}$	$V_{CC}$ and $V_{BS}$ supply undervoltage positive going threshold	8.0	8.9	9.8	V	
$V_{CCUV-}$ $V_{BSUV-}$	$V_{CC}$ and $V_{BS}$ supply undervoltage negative going threshold	7.4	8.2	9.0		
$V_{CCUVH}$ $V_{BSUVH}$	Hysteresis	0.3	0.7	—		
$I_{O+}$	Output high short circuit pulsed current	2.0	4.0	—	A	$V_O = 0$ V, $PW \leq 10$ $\mu$ s
$I_{O-}$	Output low short circuit pulsed current	2.0	4.0	—		$V_O = 15$ V, $PW \leq 10$ $\mu$ s

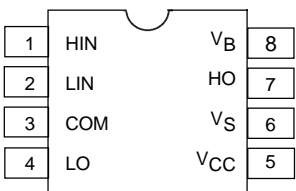
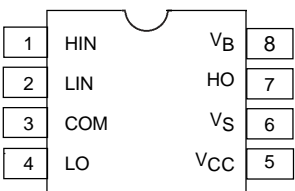
## Functional Block Diagrams

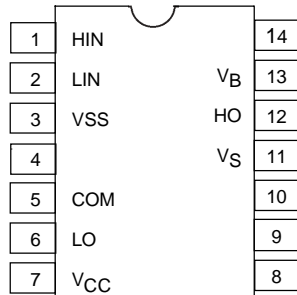
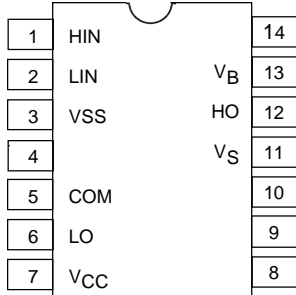


## Lead Definitions

Symbol	Description
HIN	Logic input for high side gate driver output (HO), in phase (IRS2186/IRS21864)
LIN	Logic input for low side gate driver output (LO), in phase (IRS2186/IRS21864)
VSS	Logic ground (IRS21864 only)
V <sub>B</sub>	High side floating supply
HO	High side gate drive output
V <sub>S</sub>	High side floating supply return
V <sub>CC</sub>	Low side and logic fixed supply
LO	Low side gate drive output
COM	Low side return

## Lead Assignments

 <p>8-Lead PDIP</p>	 <p>8-Lead SOIC</p>
<b>IRS2186PbF</b>	<b>IRS2186SPbF</b>

 <p>14-Lead PDIP</p>	 <p>14-Lead SOIC</p>
<b>IRS21864PbF</b>	<b>IRS21864SPbF</b>

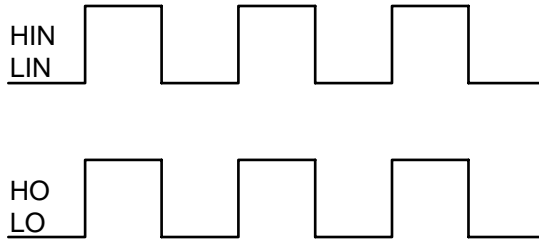


Figure 1. Input/Output Timing Diagram

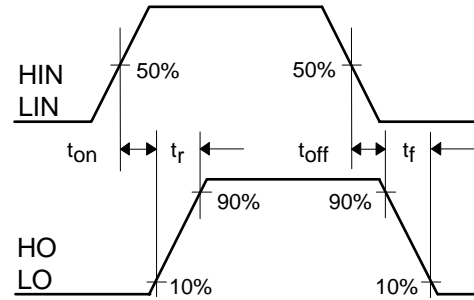


Figure 2. Switching Time Waveform Definition

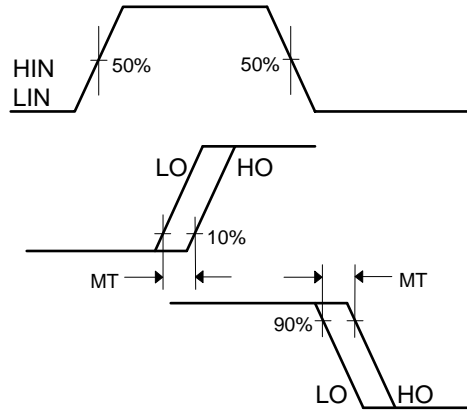
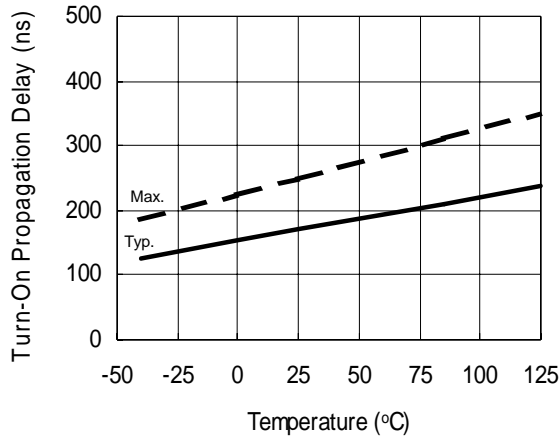
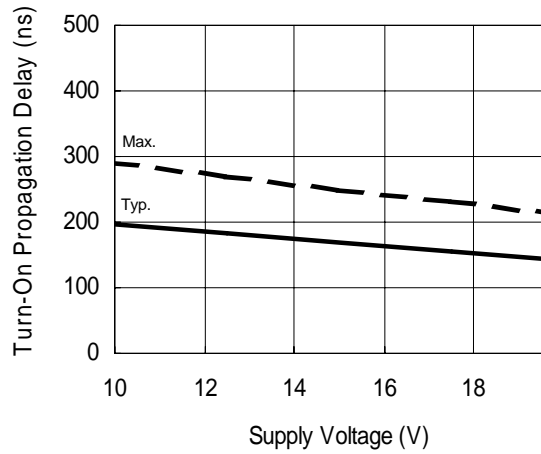


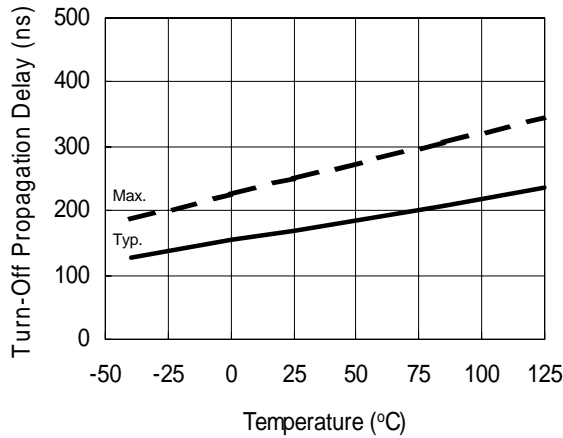
Figure 3. Delay Matching Waveform Definitions



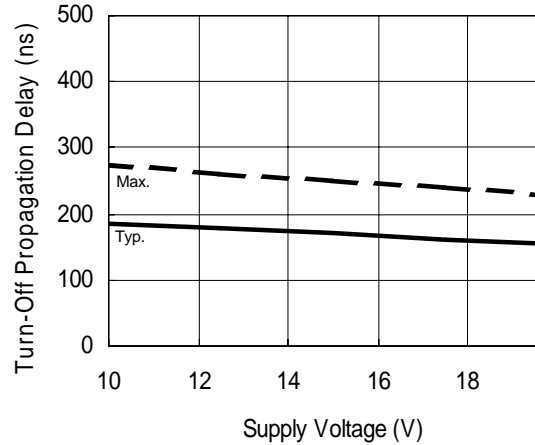
**Figure 4A. Turn-On Propagation Delay vs. Temperature**



**Figure 4B. Turn-On Propagation Delay vs. Supply Voltage**



**Figure 5A. Turn-Off Propagation Delay vs. Temperature**



**Figure 5B. Turn-Off Propagation Delay vs. Supply Voltage**

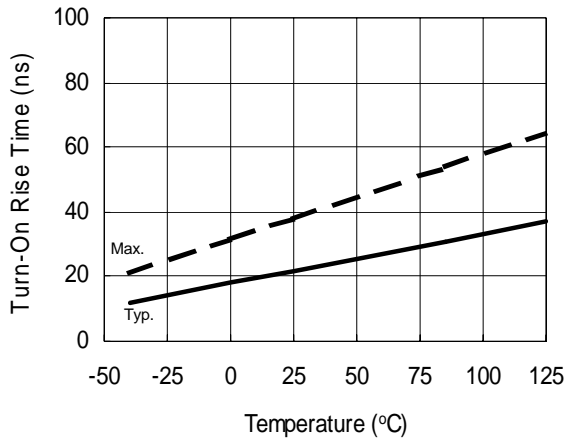


Figure 6A. Turn-On Rise Time vs. Temperature

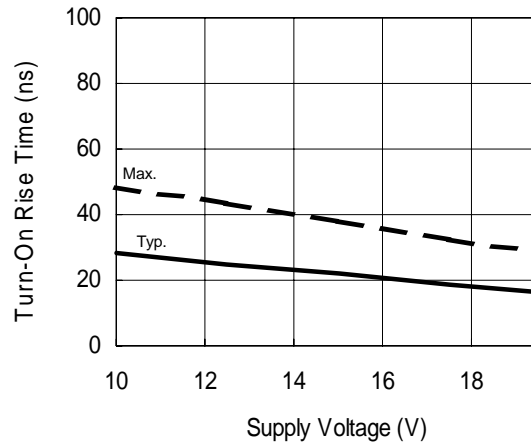


Figure 6B. Turn-On Rise Time vs. Supply Voltage

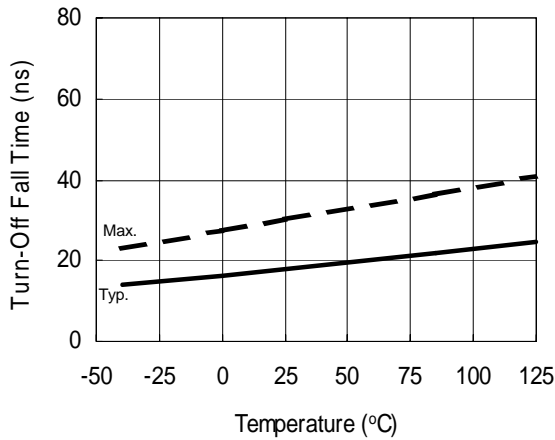


Figure 7A. Turn-Off Fall Time vs. Temperature

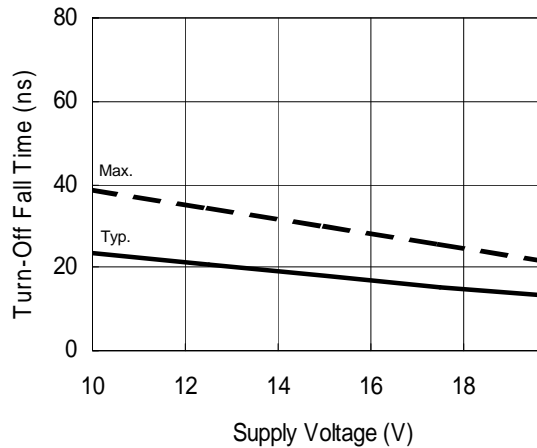
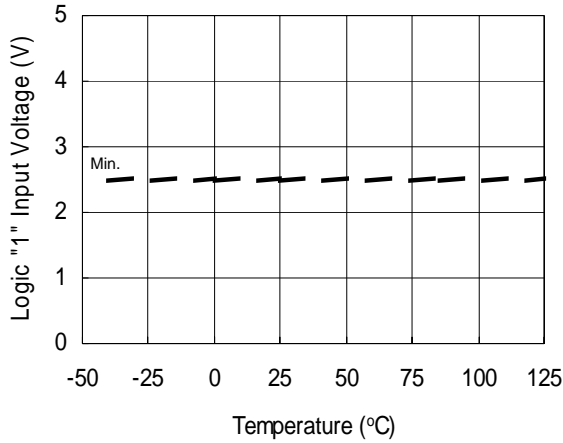
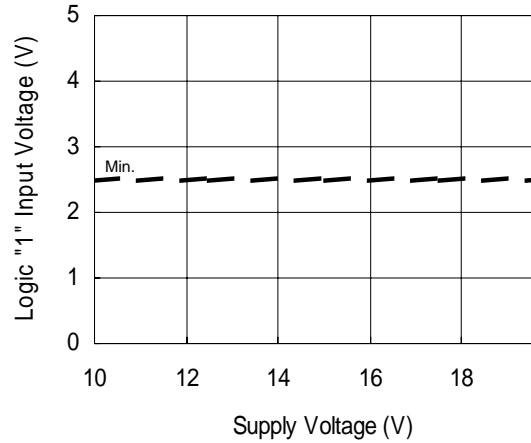


Figure 7B. Turn-Off Fall Time vs. Supply Voltage

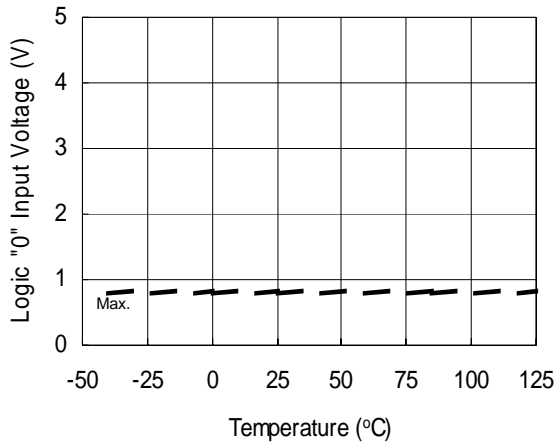




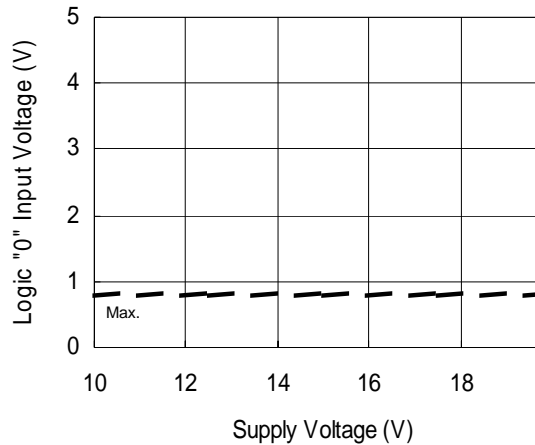
**Figure 8A. Logic "1" Input Voltage vs. Temperature**



**Figure 8B. Logic "1" Input Voltage vs. Supply Voltage**



**Figure 9A. Logic "0" Input Voltage vs. Temperature**



**Figure 9B. Logic "0" Input Voltage vs. Supply Voltage**

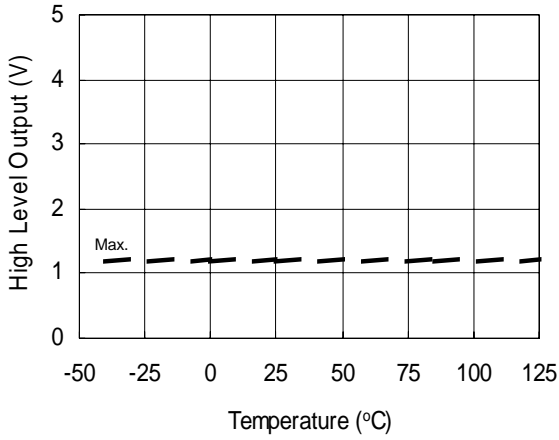


Figure 10A. High Level Output vs. Temperature

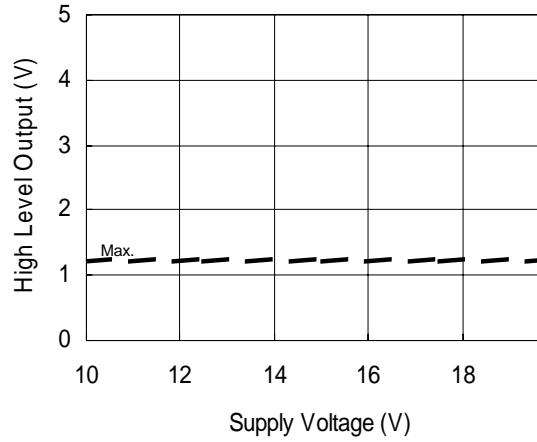


Figure 10B. High Level Output vs. Supply Voltage

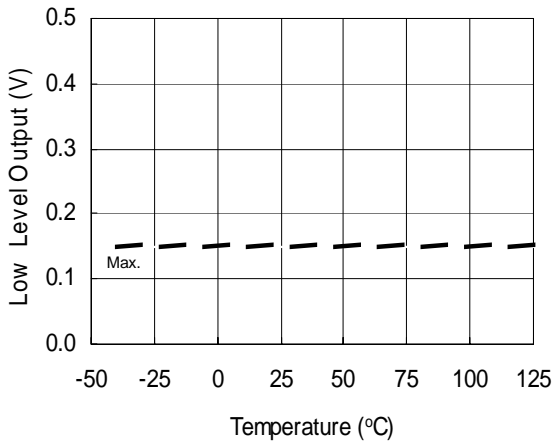


Figure 11A. Low Level Output vs. Temperature

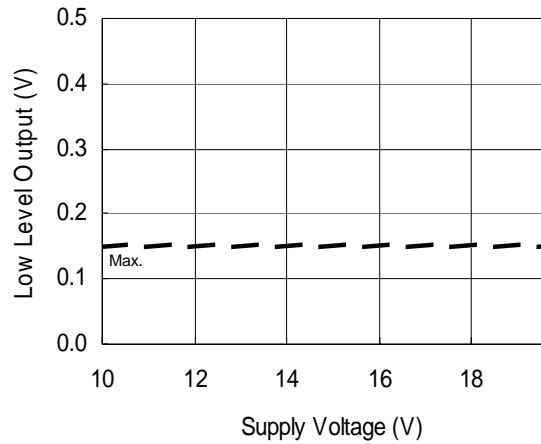
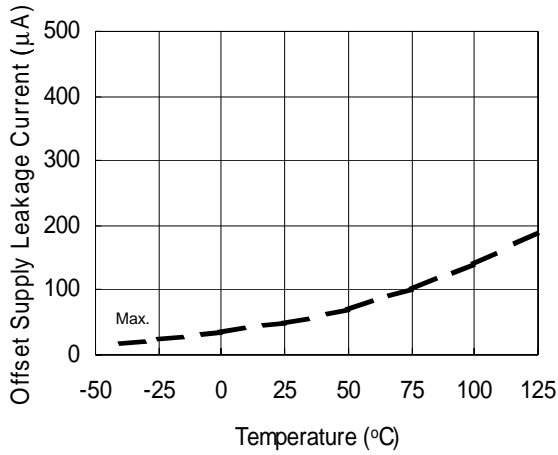
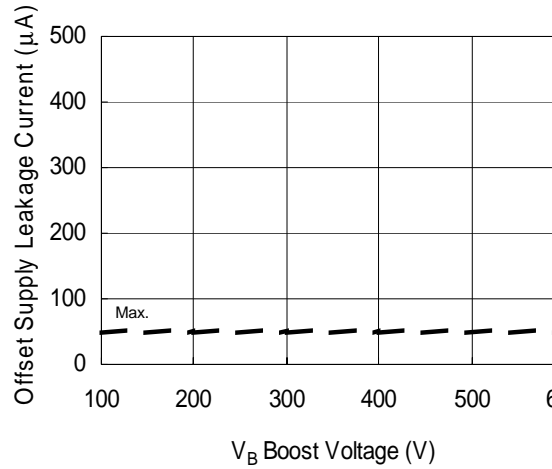


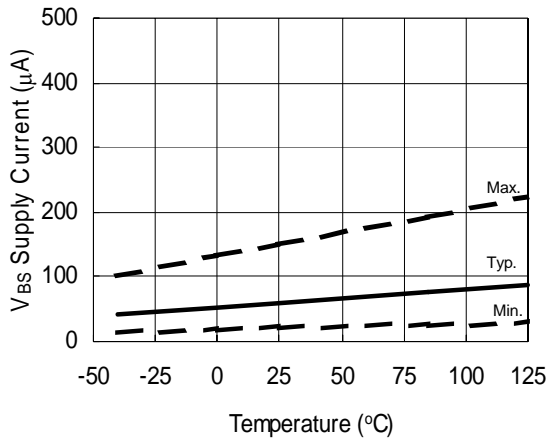
Figure 11B. Low Level Output vs. Supply Voltage



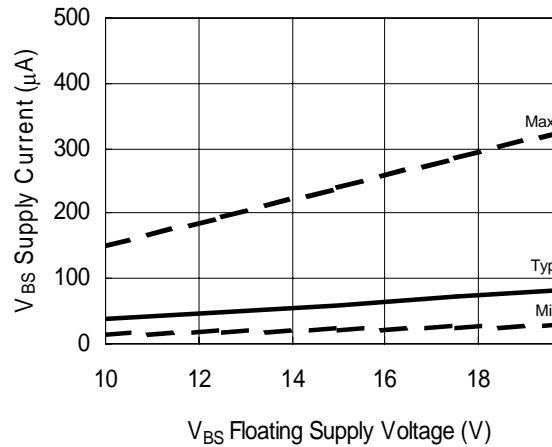
**Figure 12A. Offset Supply Leakage Current**



**Figure 12B. Offset Supply Leakage Current vs. V<sub>B</sub> Boost Voltage**



**Figure 13A. V<sub>BS</sub> Supply Current vs. Temperature**



**Figure 13B. V<sub>BS</sub> Supply Current vs. V<sub>BS</sub> Floating Supply Voltage**

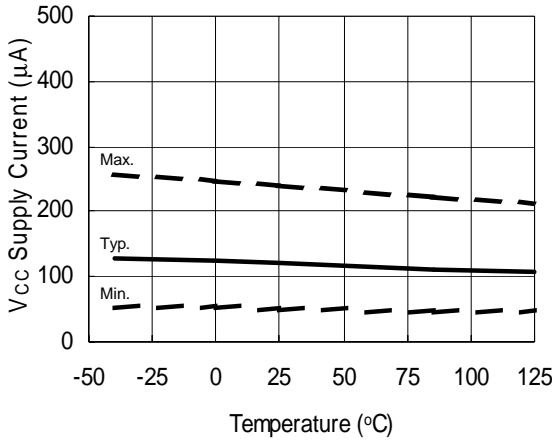


Figure 14A.  $V_{CC}$  Supply Current vs. Temperature

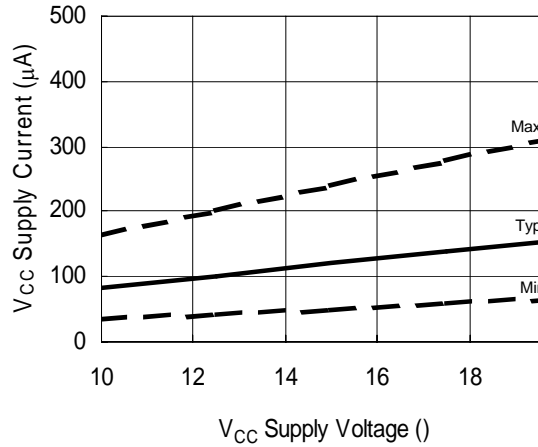


Figure 14B.  $V_{CC}$  Supply Current vs. Supply Voltage

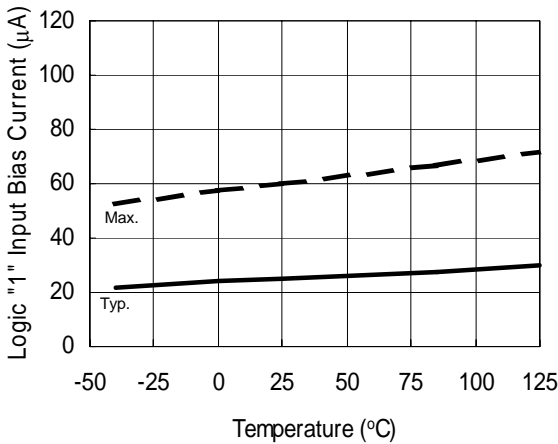


Figure 15A. Logic "1" Input Bias Current vs. Temperature

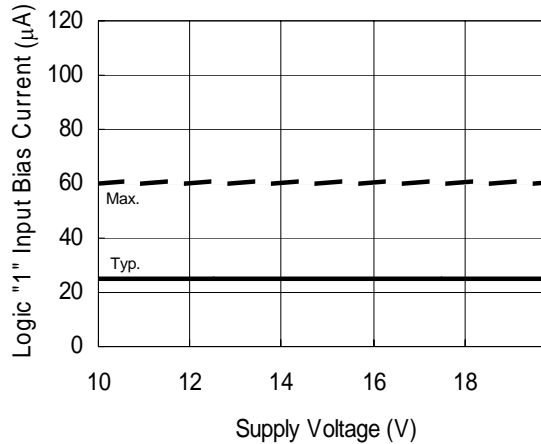
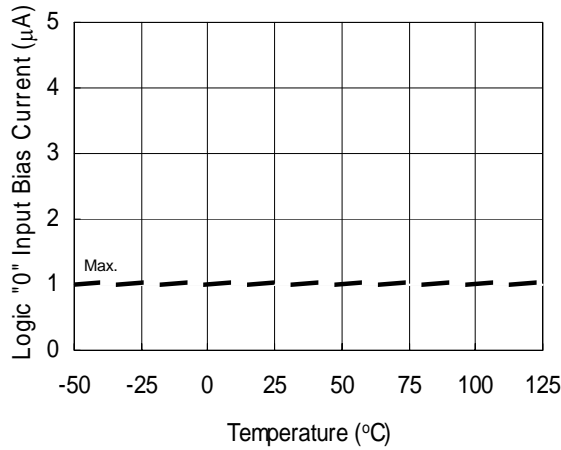
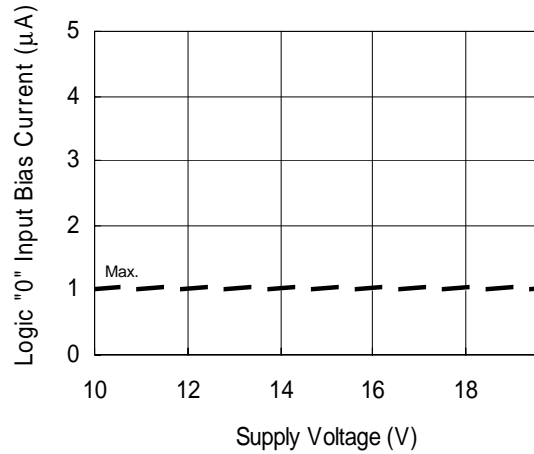


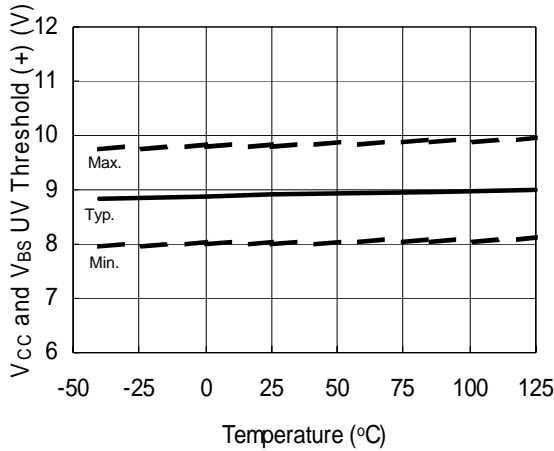
Figure 15B. Logic "1" Input Bias Current vs. Supply Voltage



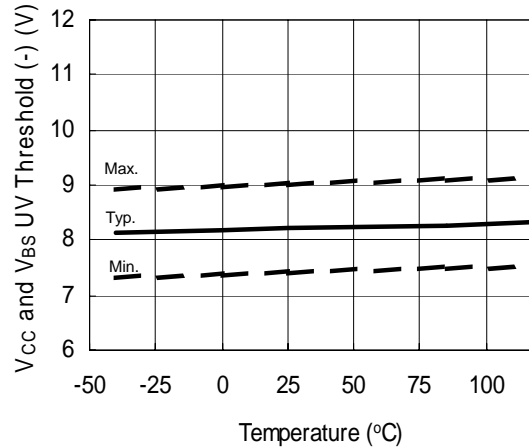
**Figure 16A. Logic "0" Input Bias Current vs. Temperature**



**Figure 16B. Logic "0" Input Bias Current vs. Supply Voltage**



**Figure 17. V<sub>CC</sub> and V<sub>BS</sub> Undervoltage Threshold (+) vs. Temperature**



**Figure 18. V<sub>CC</sub> and V<sub>BS</sub> Undervoltage Threshold (-) vs. Temperature**

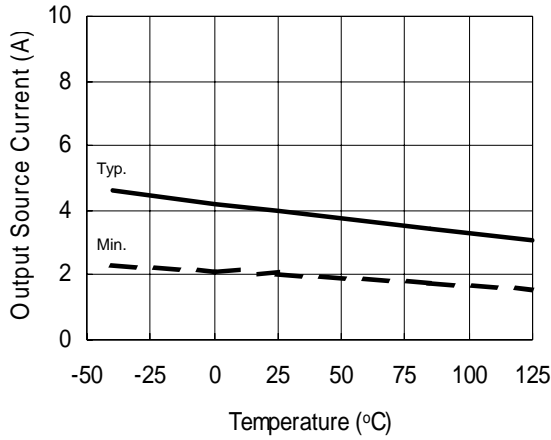


Figure 19A. Output Source Current vs. Temperature

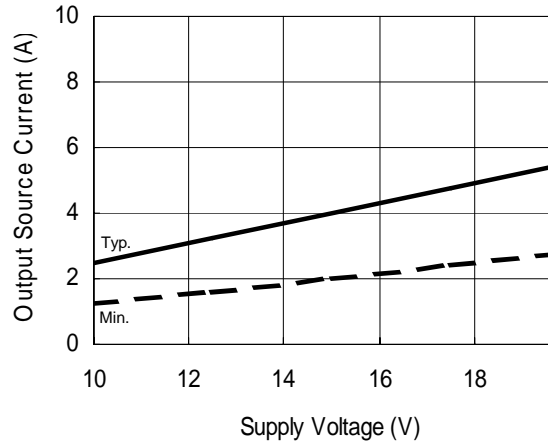


Figure 19B. Output Source Current vs. Supply Voltage

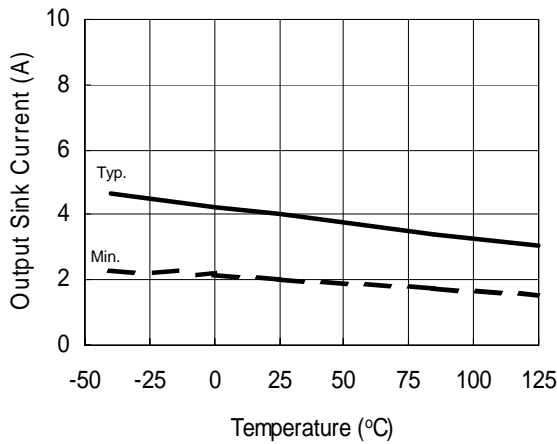


Figure 20A. Output Sink Current vs. Temperature

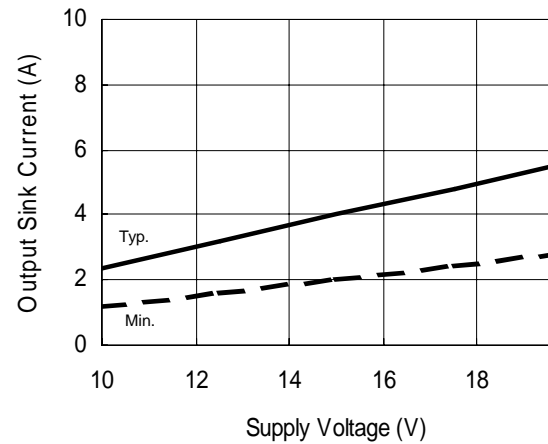
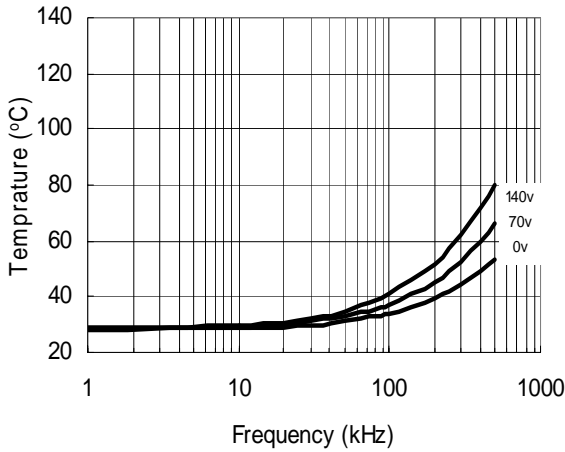
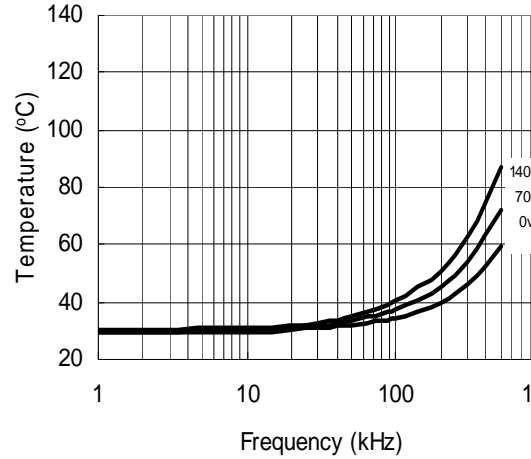


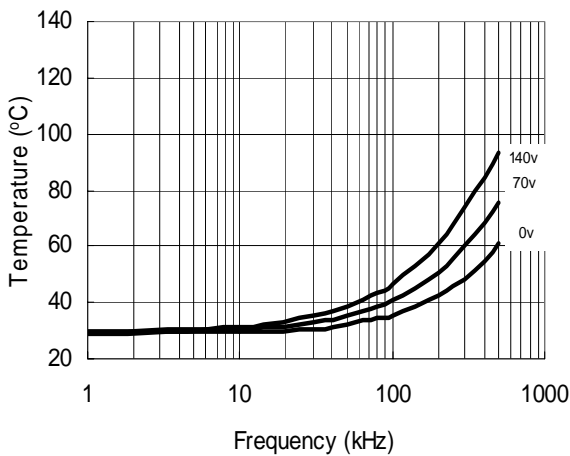
Figure 20B. Output Sink Current vs. Supply Voltage



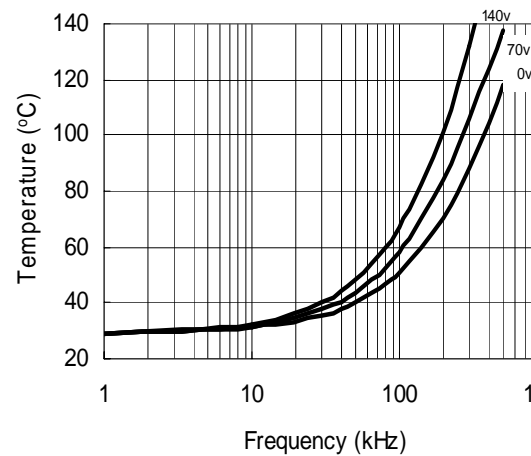
**Figure 21. IRS2186 vs. Frequency (IRFBC20),  
 $R_{gate}=33 \Omega, V_{CC}=15 V$**



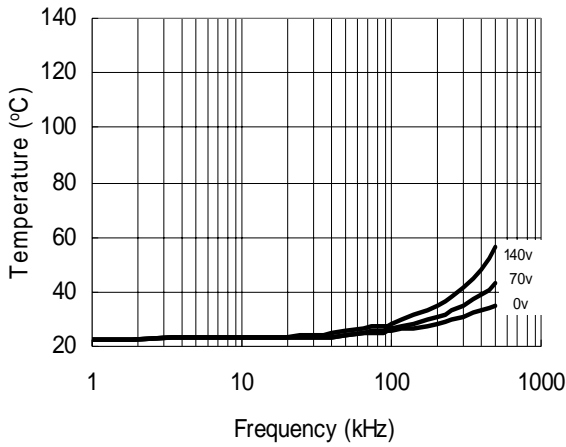
**Figure 22. IRS2186 vs. Frequency (IRFBC30)  
 $R_{gate}=22 \Omega, V_{CC}=15 V$**



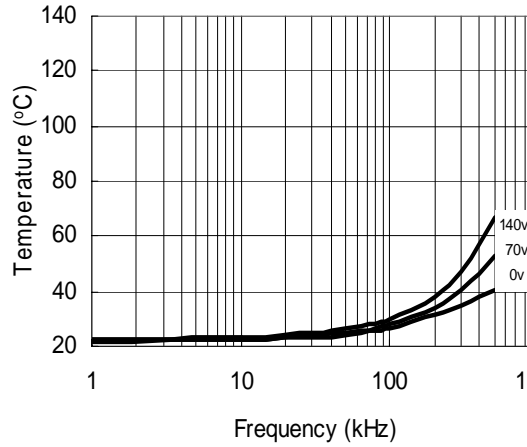
**Figure 23. IRS2186 vs. Frequency (IRFBC40),  
 $R_{gate}=15 \Omega, V_{CC}=15 V$**



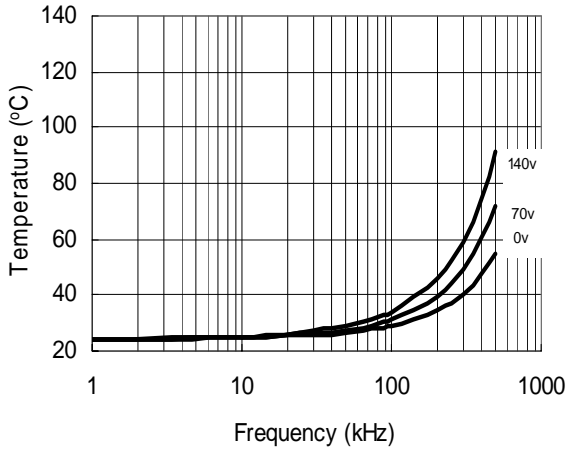
**Figure 24. IRS2186 vs. Frequency (IRFPE50)  
 $R_{gate}=10 \Omega, V_{CC}=15 V$**



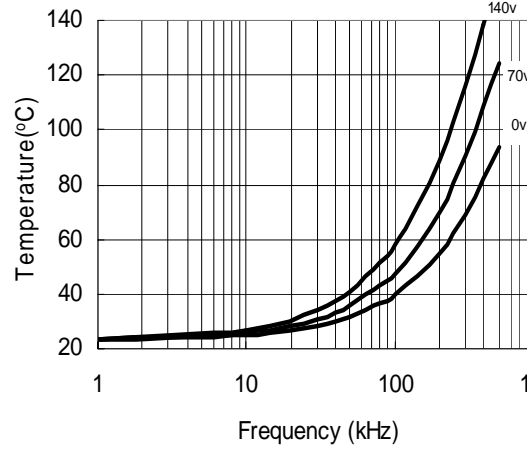
**Figure 25. IRS21864 vs. Frequency (IRFBC20),  
 R<sub>gate</sub>=33 Ω, V<sub>CC</sub>=15 V**



**Figure 26. IRS21864 vs. Frequency (IRFBC30),  
 R<sub>gate</sub>=22 Ω, V<sub>CC</sub>=15 V**

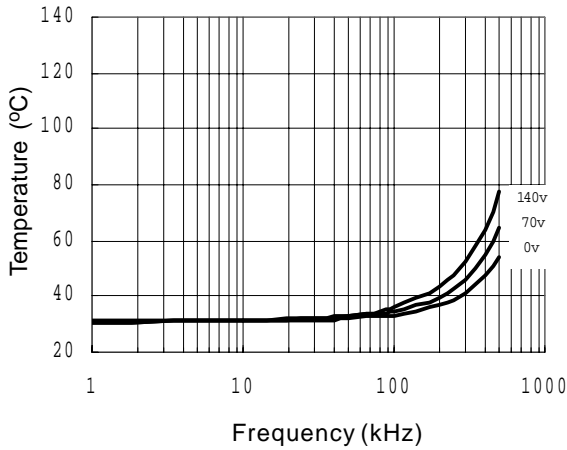


**Figure 27. IRS21864 vs. Frequency (IRFBC40),  
 R<sub>gate</sub>=15 Ω, V<sub>CC</sub>=15 V**

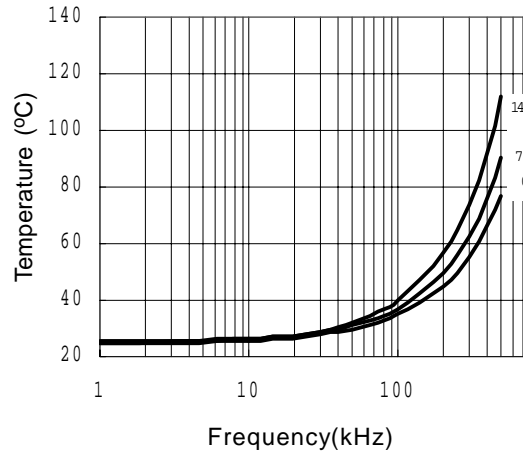


**Figure 28. IRS21864 vs. Frequency (IRFPE50),  
 R<sub>gate</sub>=10 Ω, V<sub>CC</sub>=15 V**

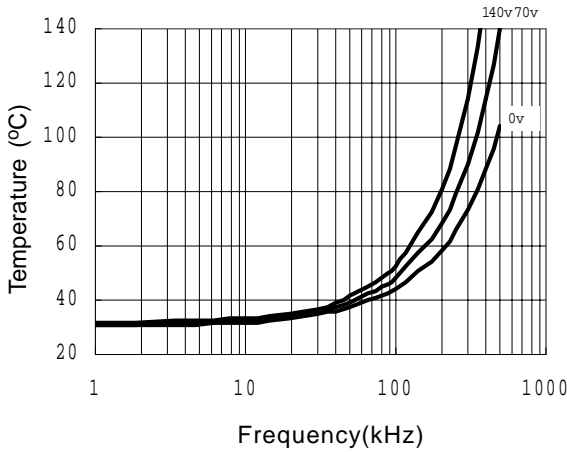




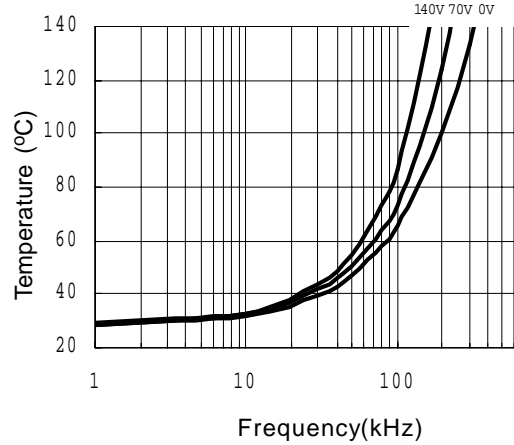
**Figure 29. IRS2186S vs. Frequency (IRFBC20),  
 $R_{gate} = 33 \Omega$ ,  $V_{CC} = 15 V$**



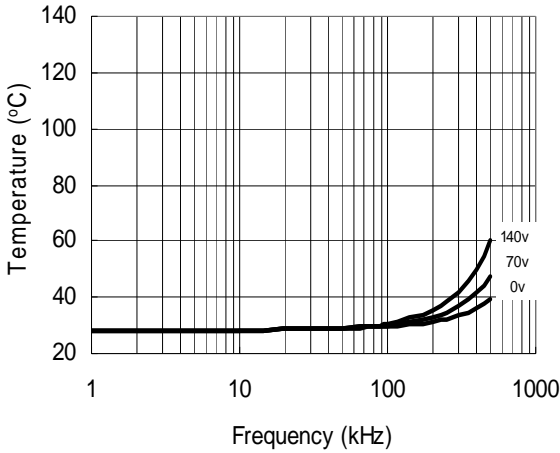
**Figure 30. IRS2186S vs. Frequency (IRFBC20),  
 $R_{gate} = 22 \Omega$ ,  $V_{CC} = 15 V$**



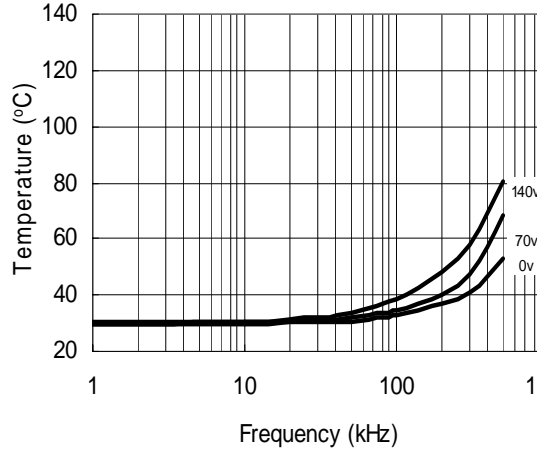
**Figure 31. IRS2186S vs. Frequency (IRFBC40),  
 $R_{gate} = 15 \Omega$ ,  $V_{CC} = 15 V$**



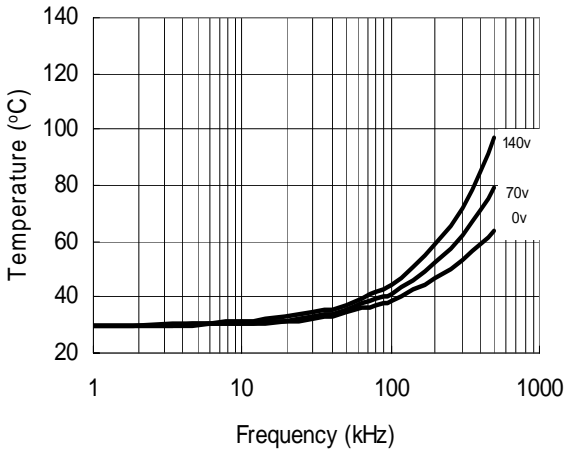
**Figure 32. IRS2186S vs. Frequency (IRFBC40),  
 $R_{gate} = 10 \Omega$ ,  $V_{CC} = 15 V$**



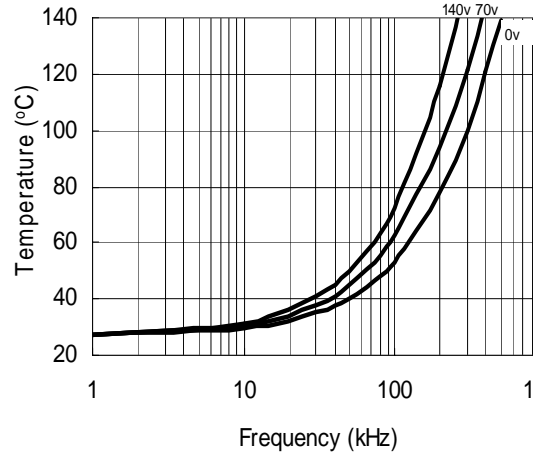
**Figure 33. IRS21864S vs. Frequency (IRFBC20),  
 $R_{gate}=33 \Omega$ ,  $V_{CC}=15 V$**



**Figure 34. IRS21864S vs. Frequency (IRFBC30),  
 $R_{gate}=22 \Omega$ ,  $V_{CC}=15 V$**

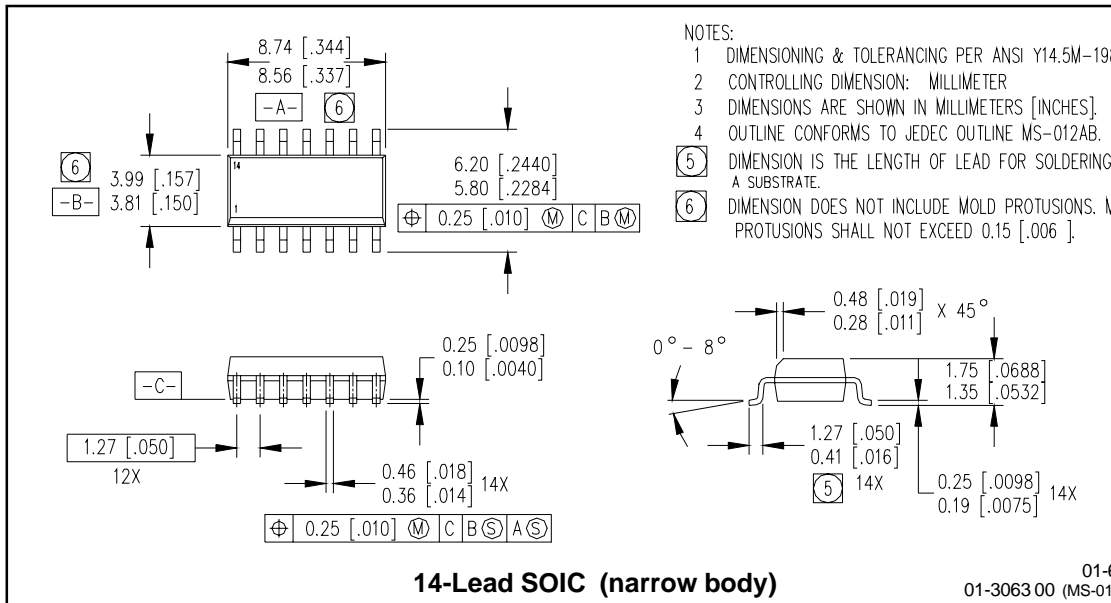
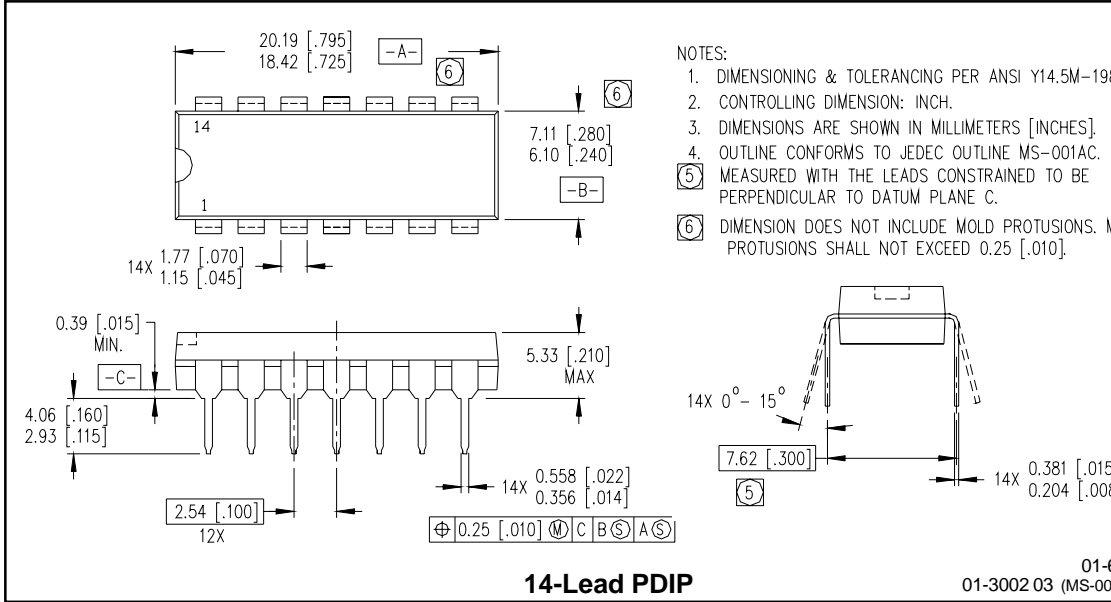


**Figure 35. IRS21864S vs. Frequency (IRFBC40),  
 $R_{gate}=15 \Omega$ ,  $V_{CC}=15 V$**

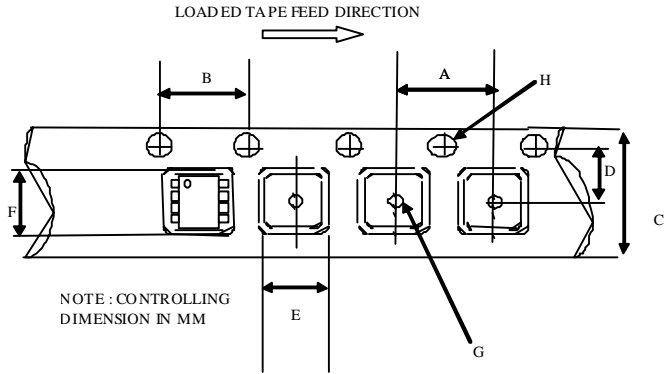


**Figure 36. IRS21864S vs. Frequency (IRFPE50),  
 $R_{gate}=10 \Omega$ ,  $V_{CC}=15 V$**



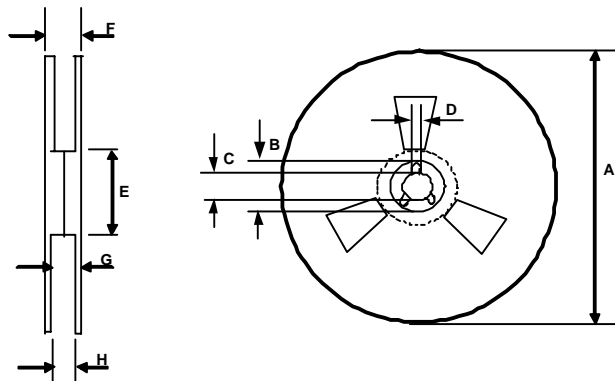


**Tape & Reel  
8-lead SOIC**



CARRIER TAPE DIMENSION FOR 8SOIC

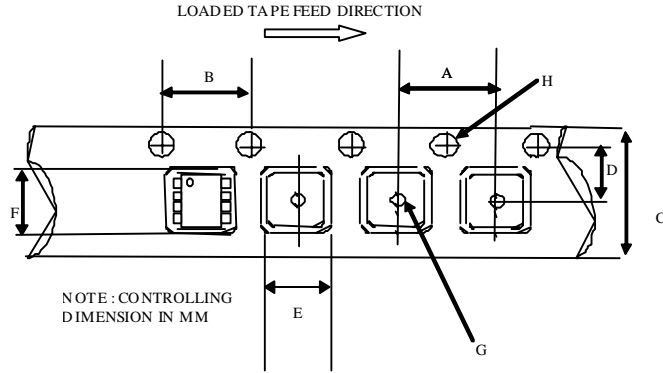
Code	Metric		Imperial	
	Min	Max	Min	Max
A	7.90	8.10	0.311	0.318
B	3.90	4.10	0.153	0.161
C	11.70	12.30	0.46	0.484
D	5.45	5.55	0.214	0.218
E	6.30	6.50	0.248	0.255
F	5.10	5.30	0.200	0.208
G	1.50	n/a	0.059	n/a
H	1.50	1.60	0.059	0.062



REEL DIMENSIONS FOR 8SOIC

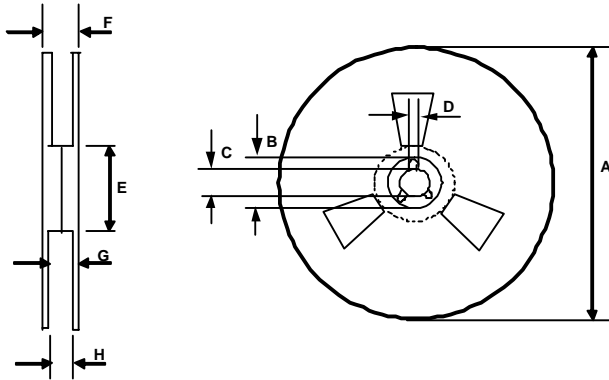
Code	Metric		Imperial	
	Min	Max	Min	Max
A	329.60	330.25	12.976	13.001
B	20.95	21.45	0.824	0.844
C	12.80	13.20	0.503	0.519
D	1.95	2.45	0.767	0.096
E	98.00	102.00	3.858	4.015
F	n/a	18.40	n/a	0.724
G	14.50	17.10	0.570	0.673
H	12.40	14.40	0.488	0.566

**Tape & Reel  
14-lead SOIC**



CARRIER TAPE DIMENSION FOR 14SOICN

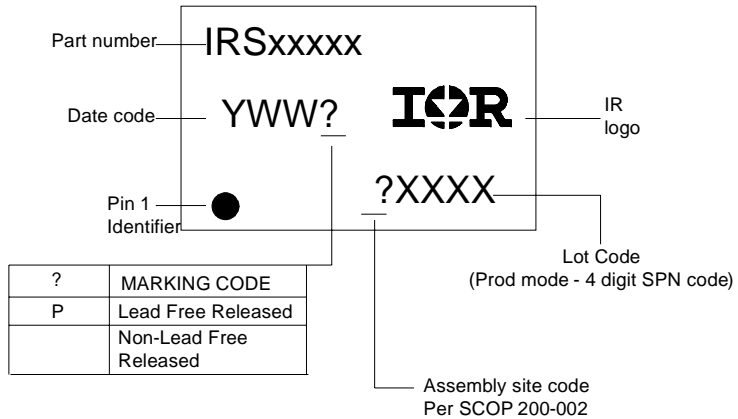
Code	Metric		Imperial	
	Min	Max	Min	Max
A	7.90	8.10	0.311	0.318
B	3.90	4.10	0.153	0.161
C	15.70	16.30	0.618	0.641
D	7.40	7.60	0.291	0.299
E	6.40	6.60	0.252	0.260
F	9.40	9.60	0.370	0.378
G	1.50	n/a	0.059	n/a
H	1.50	1.60	0.059	0.062



REEL DIMENSIONS FOR 14SOICN

Code	Metric		Imperial	
	Min	Max	Min	Max
A	329.60	330.25	12.976	13.001
B	20.95	21.45	0.824	0.844
C	12.80	13.20	0.503	0.519
D	1.95	2.45	0.767	0.096
E	98.00	102.00	3.858	4.015
F	n/a	22.40	n/a	0.881
G	18.50	21.10	0.728	0.830
H	16.40	18.40	0.645	0.724

## LEADFREE PART MARKING INFORMATION



## ORDER INFORMATION

8-Lead PDIP IRS2186PbF	14-Lead PDIP IRS21864PbF
8-Lead SOIC IRS2186SPbF	14-Lead SOIC IRS21864SPbF
8-Lead SOIC Tape & Reel IRS2186STRPbF	14-Lead SOIC Tape & Reel IRS21864STRPbF