

International IOR Rectifier

IR3314(S)PbF

PROGRAMMABLE CURRENT SENSE HIGH SIDE SWITCH

Features

- Load current feedback
- Programmable over current shutdown
- Active clamp
- ESD protection
- Input referenced to Vcc
- Over temperature shutdown
- Reverse battery protection
- Lead-Free

Description

The IR3314(S)PbF is a fully protected 4 terminals high side switch. The input signal is referenced to Vcc. When the input voltage $V_{cc} - V_{in}$ is higher than the specified threshold, the output power Mosfet is turned on. When the $V_{cc} - V_{in}$ is lower than the specified V_{il} threshold, the output Mosfet is turned off. A current proportional to the power Mosfet current is sourced to the Ifb pin. Over current shutdown occurs when $V_{st} - V_{in} > 4.5V$. The current shutdown threshold is adjusted by selecting the proper Rlfb. Either over current and over temperature latches off the switch. The device is reset by pulling the input pin high. Other integrated protections (ESD, reverse battery, active clamp) make the switch very rugged in automotive environment.

Typical Connection

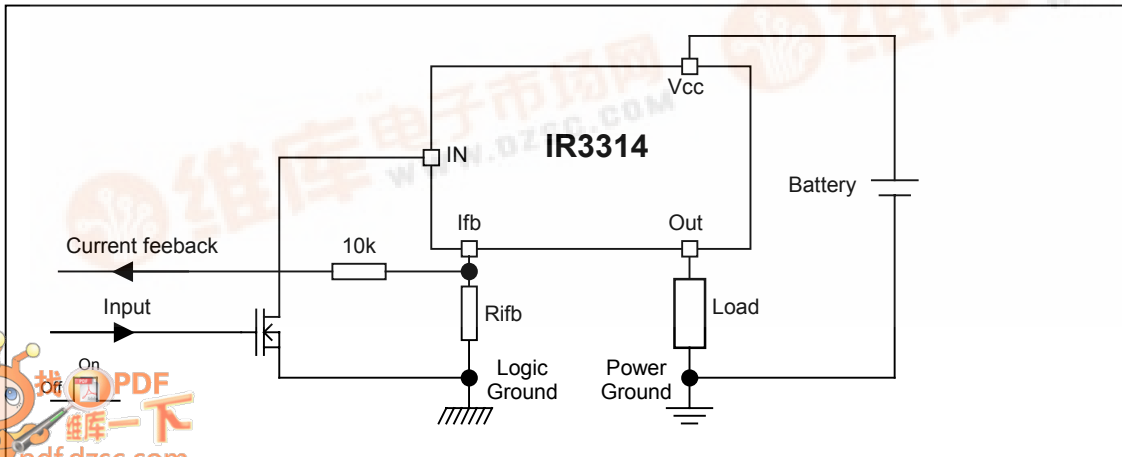

Product Summary

Rds(on)	12 mΩ max.
Vcc op.	6 to 32V
Current Ratio	5300
Prog. Ishutdown	6 to 58A
Vclamp	40V

Packages

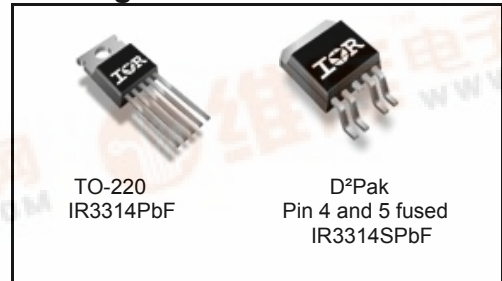

Absolute Maximum Ratings

Absolute maximum ratings indicate sustained limits beyond which damage to the device may occur. All voltage parameters are referenced to Vcc lead. (Tambient=25°C unless otherwise specified).

Symbol	Parameter	Min.	Max.	Units
Vcc-Vin	Maximum Vcc voltage	-16	37	V
Vcc-Vin cont.	Maximum continuous Vcc voltage	-16	32	
Vcc-Vfb	Maximum lfb voltage	-16	33	
Vcc-Vout	Maximum output voltage	-0.3	37	A
Ids cont.	Maximum body diode continuous current Rth=60°C/W (1)	—	2.8	
Ids pulsed	Maximum body diode pulsed current (1)	—	100	W
Pd	Maximum power dissipation Rth=60°C/W	—	2	
ESD1	Electrostatic discharge voltage (Human body) C=100pF, R=1500Ω	—	4	kV
ESD2	Electrostatic discharge voltage (Machine Model) C=200pF,R=0Ω	—	0.5	
Tj max.	Max. storage & operating temperature junction temperature	-40	150	°C
Min Rfb	Minimum on the resistor on lfb pin	0.3	—	kΩ
lfb max.	Max. lfb current	-50	50	mA

(1) Limited by junction temperature. Pulsed is also limited by wiring

Thermal Characteristics

Symbol	Parameter	Typ.	Max.	Units
Rth1	Thermal resistance junction to ambient D ² -Pak Std footprint	60	—	°C/W
Rth2	Thermal resistance junction to case D ² -Pak	1.2	—	
Rth3	Thermal resistance junction to case TO-220	1.2	—	

Recommended Operating Conditions

These values are given for a quick design. For operation outside these conditions, please consult the application notes.

Symbol	Parameter	Min.	Max.	Units
Iout	Continuous output current	—	18	A
			5	
			—	
Rifb	Recommended lfb resistor (2)(3)	0.5	3.5	kΩ
Pulse min.	Minimum turn-on pulse width	1	—	ms
Fmax.	Maximum operating frequency	—	200	Hz

2) If Rifb is too low, the device can be damaged.

3) If Rifb is too high, the device may not switch on.

Protection Characteristics

T_j=25°C, R_{ifb}=500 to 3.5kΩ

Symbol	Parameter	Min.	Typ.	Max.	Units	Test Conditions
V _{ifb-Vin@Isd}	Over-current shutdown threshold	4	4.7	5.6	V	
T _{sd}	Over temperature threshold	—	165	—	°C	See fig. 5
OV	Over voltage protection (not latched)	33	35	39	V	
Isdf	Fixed over current shutdown	58	72	90	A	V _{ifb} <V _{ifb-Vin@Isd}
Isd_1k	Programmable over current shutdown 1k	18	24	31		R _{ifb} =1kΩ
T _{reset}	Time to reset protection	—	50	500	μs	See fig. 5
Min. pulse	Min. pulse width (no WAIT state)	200	400	1200		
WAIT	WAIT function timer	0.4	1	2	ms	See fig. 4 and 5
R _{ds(on) rev.}	Reverse battery On state resistance	6	10	18	mΩ	V _{cc-Vin} =-14V, I _{out} =20A

Static Electrical Characteristics

T_j=25°C, V_{cc}=14V (unless otherwise specified)

Symbol	Parameter	Min.	Typ.	Max.	Units	Test Conditions
V _{cc op.}	Operating Voltage range	6	—	32	V	
I _{cc off}	Supply leakage current	—	1.5	5	μA	V _{in} =V _{cc} , V _{cc-Vout} =14V, V _{cc-Vifb} =14V
I _{in, on}	On state I _N positive current	1.5	3	6	mA	V _{cc-Vin} =14V
V _{ih}	High level Input threshold voltage (4)	—	5.4	6.2	V	
V _{il}	Low level Input threshold voltage (4)	4	4.9	5.8		
V _{hyst}	Input hysteresis V _{ih} -V _{il}	0.2	0.4	1		
I _{out}	Drain to source leakage current	—	1.2	5	μA	V _{in} =V _{cc} , V _{cc-Vifb} =0V, V _{cc-Vout} =14V
R _{ds(on)}	On state resistance (5) T _j =25°C	5	9	12	mΩ	V _{in} =V _{cc} , V _{cc-Vin} =14V
	On state resistance (5) T _j =25°C	5	9.5	17		I _{out} =15A, V _{cc-Vin} =6V
	On state resistance (5) T _j =150°C	10	17	23		I _{out} =20A, V _{cc-Vin} =14V
V _{clamp1}	V _{cc} to V _{out} clamp voltage 1	36	39	—	V	I _{out} =50mA
V _{clamp2}	V _{cc} to V _{out} clamp voltage 2	—	40	43		I _{out} =20A

(4) Input thresholds are measured directly between the input pin and the tab. Any parasitic resistance in common between the load current path and the input signal path can significantly affect the thresholds.

(5) R_{ds(on)} is measured between the tab and the Out pin, 5mm away from the package.

Switching Electrical Characteristics

V_{cc}=14V, Resistive load=0.5Ω, T_j=25°C

Symbol	Parameter	Min.	Typ.	Max.	Units	Test Conditions
T _{don}	Turn on delay time to 10% V _{cc}	5	21	55	μs	See figure 2
Tr1	Rise time to V _{cc-Vout} =5V	2	8	20		
Tr2	Rise time to V _{cc-Vout} =0.1V _{cc}	7	27	70		
E _{on}	Turn on energy	—	4.5	—	mJ	
T _{doff}	Turn off delay time	13	55	140	μs	
T _f	Fall time to V _{out} =10% of V _{cc}	5	20	55		
E _{off}	Turn off energy	—	2	—	mJ	

Lead Assignments

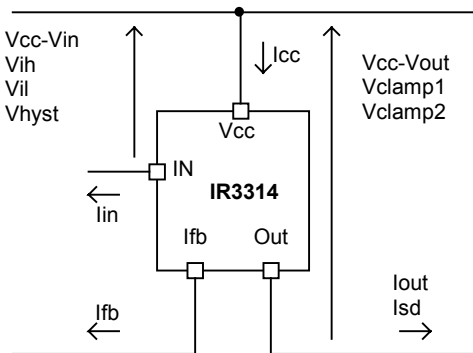
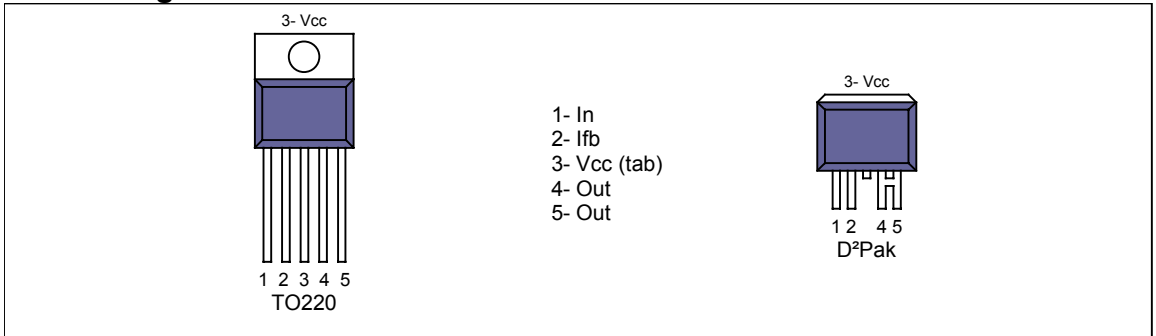

Figure 1 – Voltages and current definitions

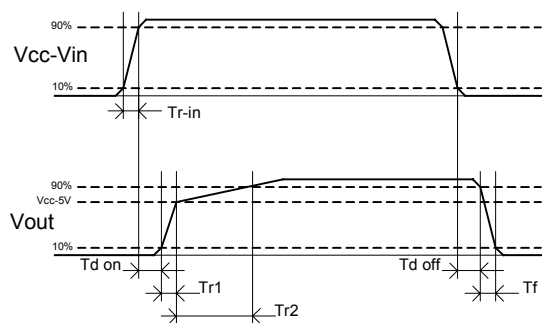

Figure 2 – Switching time definitions

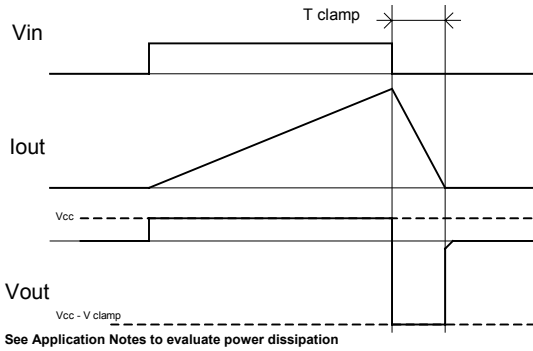

Figure 3 – Active clamp waveforms

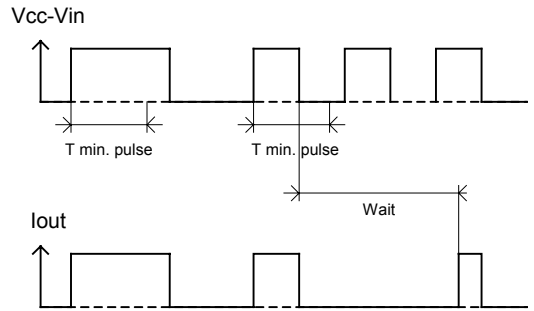

Figure 4 – Min. pulse and Wait function

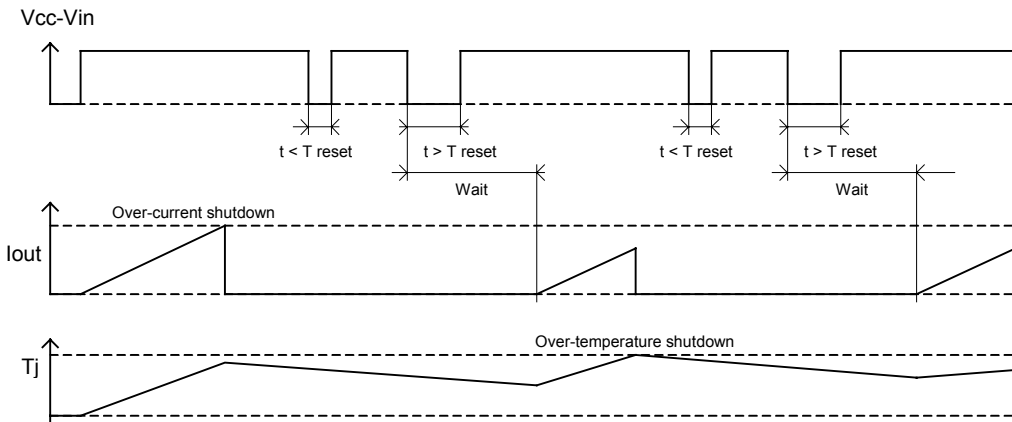

Figure 5 – Protection Timing Diagrams

All curves are typical characteristics. Operation in hatched areas is not recommended. $T_j=25^{\circ}\text{C}$, $R_{ifb}=500\text{ohm}$, $V_{cc}=14\text{V}$ (unless otherwise specified).

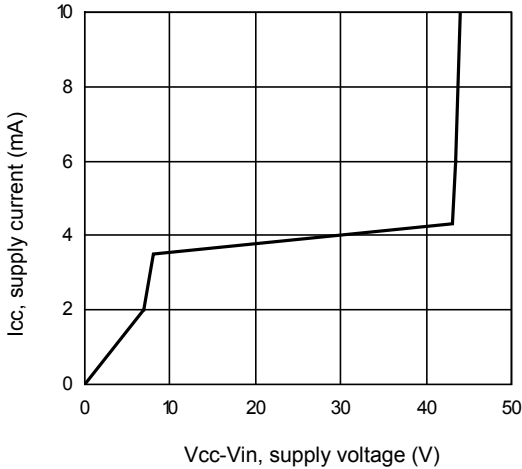

Figure 6 – Icc (mA) Vs Vcc-Vin (V)

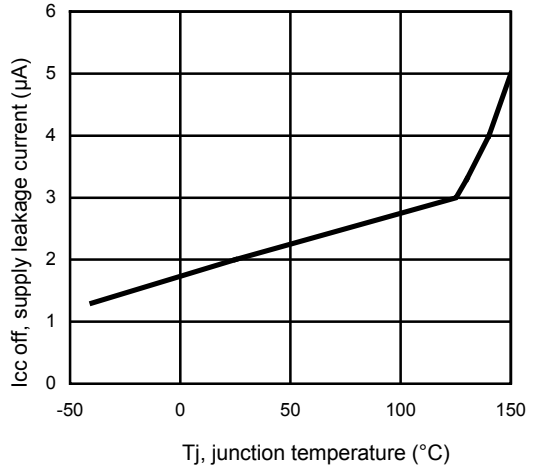

Figure 7 – Icc off (µA) Vs Tj (°C)

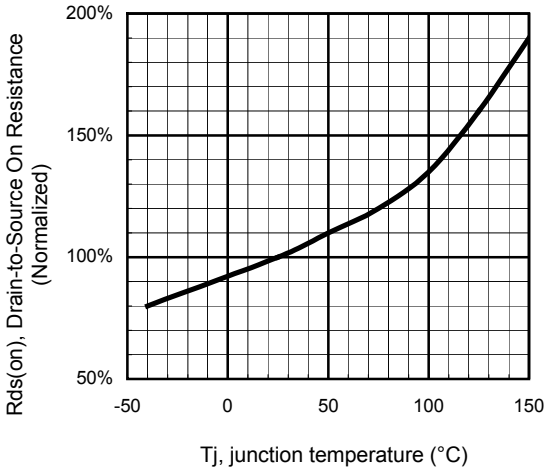

Figure 8 - Normalized Rds(on) (%) Vs Tj (°C)

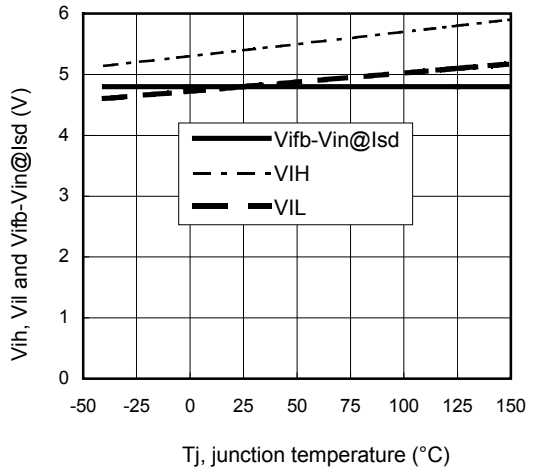

Figure 9 – Vih, Vil and Vifb-Vin@Isd (V) Vs Tj (°C)

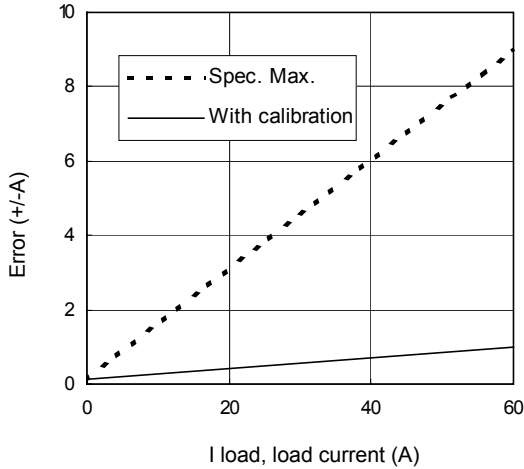

Figure 10 – Error (+/- A) Vs I load (A)

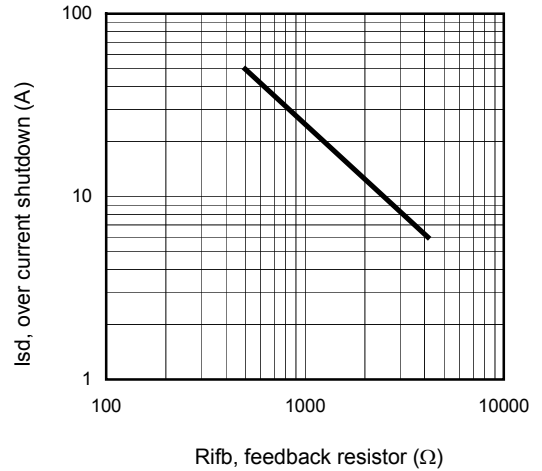

Figure 11 – Ids (A) Vs Rifb (Ω)

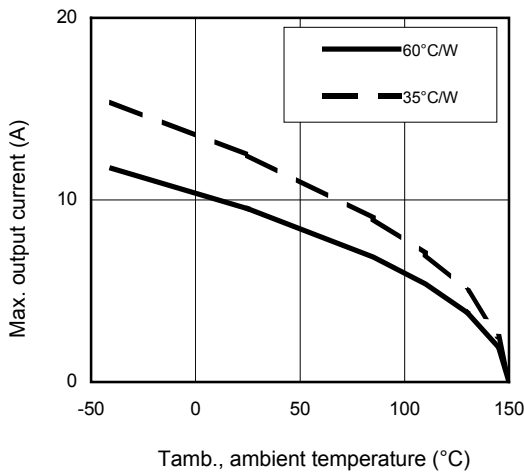

Figure 12 – Max. iout (A) Vs Tamb. (°C)

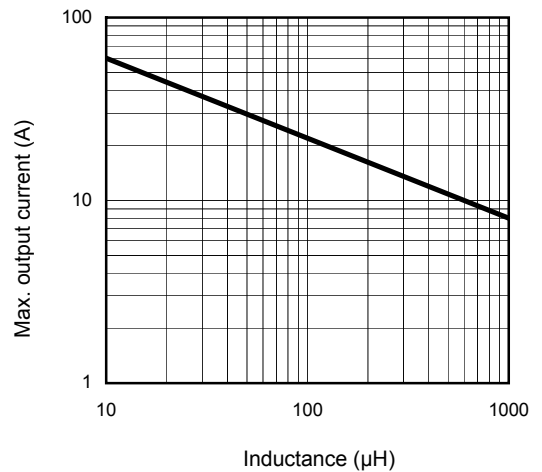

Figure 13 – Max. iout (A) Vs inductance (μH)

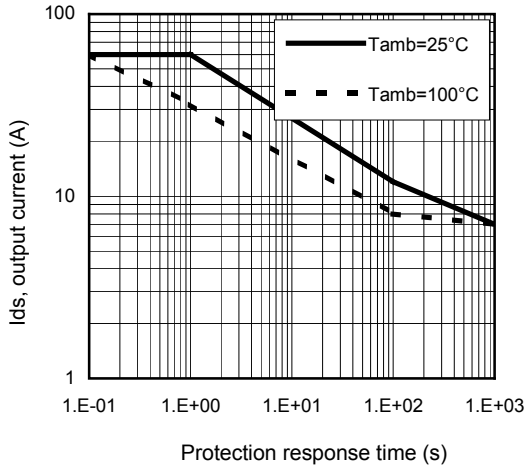

Figure 14 – Ids (A) Vs over temperature protection response time (s)

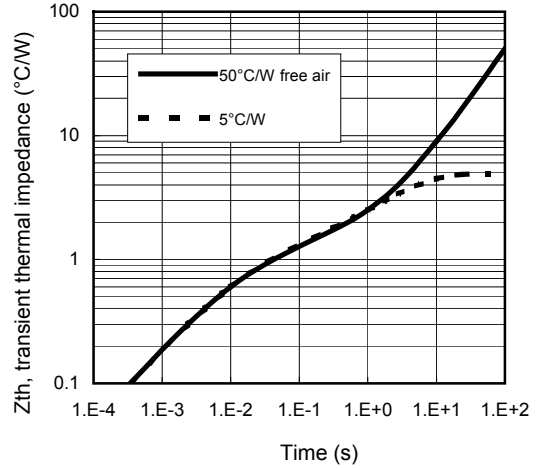
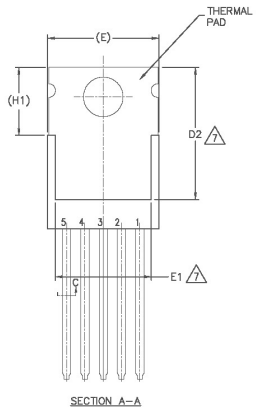
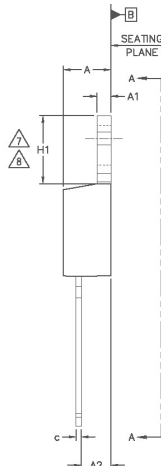
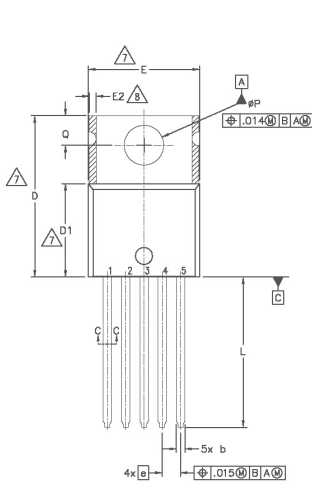

Figure 15 – Transient thermal impedance (°C/W) Vs time (s)

Case Outline 5 Leads – TO220 - Automotive Q100 PbF qualified



DIMENSIONS	DIMENSIONS				NOMINAL
	MILLIMETERS		INCHES		
	MIN.	MAX.	MIN.	MAX.	
A	3.56	4.83	.140	.190	5
A1	0.51	1.40	.020	.055	
A2	2.03	2.92	.080	.115	
b	0.64	0.89	.025	.035	
b1	0.64	0.84	.025	.033	
c	0.38	0.61	.014	.024	6
c1	0.38	0.56	.014	.022	
D	14.22	16.51	.560	.650	4
D1	8.38	9.02	.330	.355	
D2	11.68	12.86	.460	.507	7
E	9.65	10.67	.380	.420	
E1	6.86	8.89	.270	.350	7
E2	—	0.76	—	.030	
e	1.70 BSC		.067 BSC		7,8
H1	5.84	6.86	.230	.270	
L	12.70	14.73	.500	.580	
φP	3.53	3.73	.139	.147	
Q	2.54	3.05	.100	.120	

- NOTES:
- 1.- DIMENSIONING AND TOLERANCING AS PER ASME Y14.5 M- 1994.
 - 2.- DIMENSIONS ARE SHOWN IN INCHES (MILLIMETERS).
 - 3.- LEAD DIMENSION AND FINISH UNCONTROLLED IN L1.
 - 4.- DIMENSION D, D1 & E DO NOT INCLUDE MOLD FLASH. MOLD FLASH SHALL NOT EXCEED .005" (0.127) PER SIDE. THESE DIMENSIONS ARE MEASURED AT THE OUTERMOST EXTREMES OF THE PLASTIC BODY.
 - 5.- DIMENSION b1 & c1 APPLY TO BASE METAL ONLY.
 - 6.- CONTROLLING DIMENSION : INCHES.
 - 7.- THERMAL PAD CONTOUR OPTIONAL WITHIN DIMENSIONS E,H1,D2 & E1
 - 8.- DIMENSION E2 X H1 DEFINE A ZONE WHERE STAMPING AND SINGULATING IRREGULARITIES ARE ALLOWED.
 - 9.- OUTLINE CONFORMS TO JEDEC TO-220, EXCEPT A2 (max.) AND D2 (min.) WHERE DIMENSIONS ARE DERIVED FROM THE ACTUAL PACKAGE OUTLINE.
 - 10.- LEADS AND DRAIN ARE PLATED WITH 100% Sn

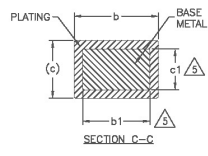

Case Outline - D2PAK 5 leads - Automotive Q100 PbF MSL1 qualified

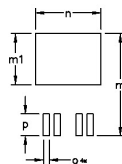
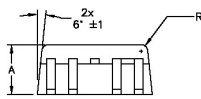
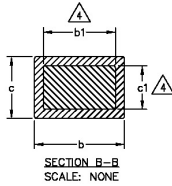
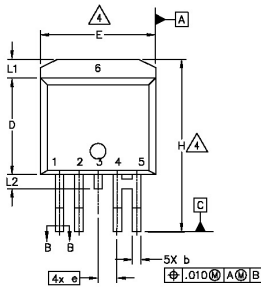
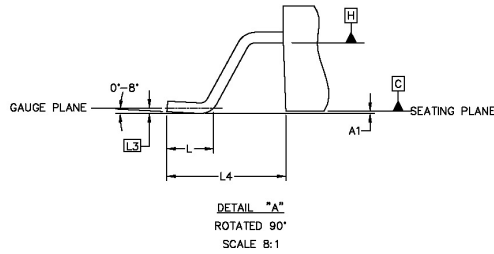
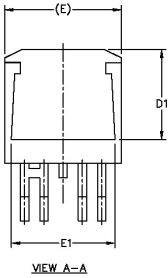

SYMBOL	DIMENSIONS				NOTES
	MILLIMETERS		INCHES		
	MIN.	MAX.	MIN.	MAX.	
A	4.06	4.83	.160	.190	4
A1		0.254		.010	
b	0.66	0.91	.026	.036	
b1	0.66	0.81	.026	.032	
c	0.38	0.74	.015	.029	4
c1	0.38	0.58	.015	.023	
c2	1.14	1.65	.045	.065	3
D	8.51	9.65	.335	.380	
D1	6.86		.270		3
E	9.65	10.67	.380	.420	
E1	6.22		.245		
e	1.70 BSC		.067 BSC		
H	14.73	15.49	.580	.609	
L	1.14	1.39	.045	.055	
L1		1.65		.065	
L2	1.27	1.78	.050	.070	
L3	0.25 BSC		.010 BSC		
L4	4.78	5.28	.188	.208	
m	17.78		.700		
m1	8.89		.350		
n	11.43		.450		
o	1.93		.076		
p	3.81		.150		
R	0.51	0.71	.020	.028	

NOTES:

1. DIMENSIONING AND TOLERANCING PER ASME Y14.5M-1994
2. DIMENSIONS ARE SHOWN IN MILLIMETERS [INCHES]
3. DIMENSION D & E DO NOT INCLUDE MOLD FLASH. MOLD FLASH SHALL NOT EXCEED 0.127 [.005"] PER SIDE. THESE DIMENSIONS ARE MEASURED AT THE OUTMOST EXTREMES OF THE PLASTIC BODY.

△ DIMENSION b1 AND c1 APPLY TO BASE METAL ONLY.

5. CONTROLLING DIMENSION: MILLIMETERS

6. LEADS AND DRAIN ARE PLATED WITH 100% Sn

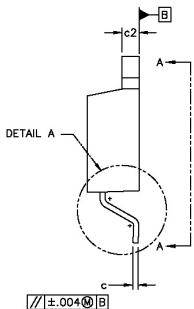

Tape & Reel 5 Lead - D2PAK

