

2.4GHz Power Amplifier and Detector



The ISL3984 is a 2.4GHz monolithic SiGe Power Amplifier designed to operate in the ISM Band. It features two low voltage single supply stages.

Cascaded, they deliver 18dBm (Typ) output power for the typical DSSS signal (ACPR, 1st Side Lobe < -30dBc, 2nd Side Lobe < -50dBc).

In addition, the device includes a 2.4GHz detector which is accurate over a 15dB dynamic range within (\pm)1dB. Therefore, an accurate ALC function can be implemented.

The ISL3984 is housed in a 16 lead MLFP package well suited for PCMCIA board applications.

Ordering Information

PART NUMBER	TEMP RANGE (°C)	PACKAGE	PKG. NO.
ISL3984IR	-40 to 85	16 Ld MLFP	L16.4x4
ISL3984IR96	-40 to 85	Tape and Reel	

Simplified Block Diagram

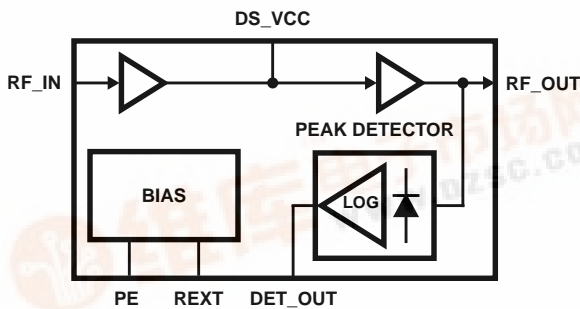

Features

- Single Supply 2.7V to 3.6V
- Output Power 18dBm (Typ) at ACPR, DSSS, 1st Side Lobe < -30dBc, 2nd Side Lobe < -50dBc
- Power Gain 30dB (Typ)
- Detector Linear Input Power Range 15dB
- Detector Accuracy \pm 1dB

Applications

- IEEE802.11 1, 2 or 5.5Mbps Standard
- Systems Targeting IEEE802.11b, 11Mbps Standard
- Wireless Local Area Networks (WLAN)
- PCMCIA Wireless Transceivers
- ISM Systems Including Automatic Level Control (ALC)
- TDMA Packet Protocol Radios

Pinouts

ISL3984 (MLFP)
TOP VIEW

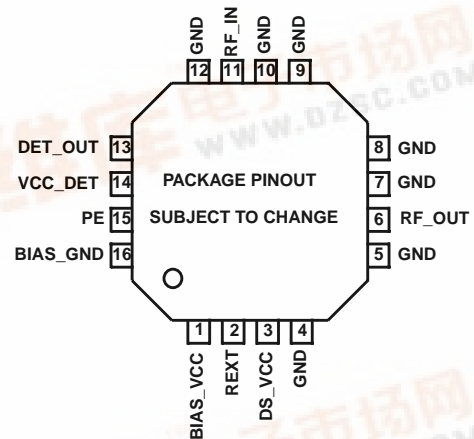

ISL3984

Pin Descriptions

PIN NUMBER	NAME	DESCRIPTION
1	BIAS_VCC	Power Supply.
2	REXT	Bias Resistor, biasing scheme independent of absolute temperature.
3	DS_VCC	Driver Stage Power Supply.
4, 5	GND	DC and RF Ground.
6	RF_OUT	RF Output of the Power Amplifier.
7, 8, 9, 10	GND	DC and RF Ground.
11	RF_IN	RF Input of the Power Amplifier.
12	GND	DC and RF Ground.
13	DET_OUT	Detector Output.
14	VCC_DET	Detector Power Supply.
15	PE	Digital Input Control Pin to enable operation of the Power Amplifier. Enable logic level is high.
16	BIAS_GND	DC and RF Ground.

The ISL3984 works seamlessly with the PRISM II and PRISM II.V WLAN chip set components to give you a highly integrated, cost effective 11Mb/s WLAN solution in the 2.4 to 2.5GHz ISM band. The ISL3984 is fabricated in the fastest SiGe BiCMOS process available allowing superior RF performance, normally found only in GaAs ICs. Cost effective functions, normally requiring external components, are integrated into one IC. The ISL3984 integrates the following functions in one compact 16 pin MLFP:

- Two Stage, 30dB Gain RFPA,
- Logarithmic power detect function (15dB Dynamic Range),
- CMOS level compatible Power Up/Down function,
- Single Supply, 2.7V to 3.6V Operation.

The ISL3984 contains a highly linear RFPA designed to deliver 18dBm and meet an ACPR specification of -30dBc in the 2.4 to 2.5GHz ISM band. The performance of this two stage RFPA can be optimized by adjusting the bias current with a dedicated resistor. No external positive or negative power supplies are required to set the bias currents. The on chip bias network provides the optimum bias current temperature compensation when low TC external resistor is used. To get the best performance from the ISL3984, the output stage matching network can be tailored using external components.

The ISL3984 power detect function provides a DC output voltage that is proportional to the logarithm of the output power. For an output power of 18dBm, the detector is accurate to within a 0.5dB. The slope of the detector output voltage is 100mV/dB over a 15dB dynamic range. A simple application of the detector is to provide in-line monitoring of the output power using a DC voltmeter. No longer is a power meter or spectrum analyzer required. A more value added application would use the HFA3861B/HFA3863 Baseband Processor to dynamically monitor the ISL3984 output power and to control transmit power by adjusting the AGC of the HFA3783 IF Quadrature Modem to provide the best possible error free data transfer rate for any given environment. Closed loop power control is very important feature which compensates for variability in the transmit chain (radio to radio, channel to channel, over temperature...).

The ISL3984 power up/down feature integrates the power down capability onto the IC and requires no external components thus freeing up board space and reducing external component count and cost. When the CMOS compatible Power Enable (PE) pin is driven low, the total supply current drops to under 50µA in, typically, 300ns. When the PE pin is driven high, the full ISL3984 output power is available in a few hundred nanoseconds.

In summary, the ISL3984 RFPA provides a highly cost effective solution for the PA function by integrating many features that would require significant development time, drive up the total bill of materials cost and consume precious board space. It mates seamlessly with the other PRISM II ICs to provide a highly integrated, cost effective 11Mb/s WLAN solution in the 2.4 to 2.5GHz ISM band.

ISL3984

Absolute Maximum Ratings

Supply Voltage	.4V
Voltage on Any Other Pin	-0.3 to $V_{CC} + 0.3V$
V_{CC} to V_{CC} Decouple	-0.3 to +0.3V
Any GND to GND	-0.3 to +0.3V

Operating Conditions

Temperature Range	-40 to 85°C
Supply Voltage Range	2.7V to 3.6V

Thermal Information

Thermal Resistance (Typical, Note 1)	θ_{JA} (°C/W)
MLFP Package	30
Maximum Junction Temperature (Plastic Package)	150°C
Maximum Storage Temperature Range	-65°C to 150°C
Maximum Lead Temperature (Soldering 10s)	300°C

CAUTION: Stresses above those listed in "Absolute Maximum Ratings" may cause permanent damage to the device. This is a stress only rating and operation of the device at these or any other conditions above those indicated in the operational sections of this specification is not implied.

NOTE:

- θ_{JA} is measured in free air with the component mounted on a high effective thermal conductivity test board with "direct attach" features. See Intersil TB379.

General DC Electrical Specifications

PARAMETER	TEMP. (°C)	MIN	TYP	MAX	UNITS
Supply Voltage	Full	2.7	-	3.6	V
Total Power Amplifier Supply Current at 3.3V, 18dBm Output	25	-	137	-	mA
RF Detector Supply Current	25	-	-	2	mA
Power Down Supply Current	Full	-	200	-	μA
Power Up/ Down Speed	Full	-	300	-	ns
CMOS Low Level Input Voltage	Full	-	-	$0.3 \cdot V_{DD}$	V
CMOS High Level Input Voltage ($V_{DD} = 3.6V$)	Full	$0.7 \cdot V_{DD}$	-	-	V
CMOS Threshold Voltage	Full	$>0.3 \cdot V_{DD}$	$0.5 \cdot V_{DD}$	$<0.7 \cdot V_{DD}$	V
CMOS High or Low Level Input Current	Full	-10	-	+10	μA

Power Amplifier AC Electrical Specifications $V_{CC} = 3.3V$, $f = 2.45GHz$, Unless Otherwise Specified. Typical Application Circuit (external input and output matching networks) has been used.

PARAMETER	TEST CONDITIONS	TEMP. (°C)	MIN	TYP	MAX	UNITS
RF Frequency Range		Full	2400	-	2500	MHz
Power/Voltage Gain		Full	27	30	35	dB
Input 50Ω VSWR		25	-	-	2:1	-
Output 50Ω VSWR		25	-	-	3:1	-
Output Power	ACPR, DSSS, 1st Side Lobe $<-30dBc$, 2nd Side Lobe $<-50dBc$	Full	-	18	-	dBm
Output Stability VSWR	Output Spurs Less than -60dBc	Full	-	-	10:1	-
Output Load Mismatch	(Note 2)	Full	-	-	10:1	-

NOTE:

- Devices sustain no damage when subjected to a mismatch of maximum 10:1.

Peak Detector AC Electrical Specifications

PARAMETER	TEST CONDITIONS	TEMP. (°C)	MIN	TYP	MAX	UNITS
RF Output Detector Response Time	External Capacitor, $C = 5pF$	Full	-	0.15	-	μs
RF Output Detector Voltage Range	Load $> 1M$	Full	0	-	1.5	V
RF Output Detector Linearity	Over Linear Range	Full	-0.5	-	0.5	dB/V
RF Output Detector Accuracy	600mV _{DC} Output	Full	-1	-	+1	dB
RF Output Detector Slope	Over Linear Range	Full	-	10	-	dB/V

Typical Application Example

ISL3984 - 16 PIN MLFP PACKAGE

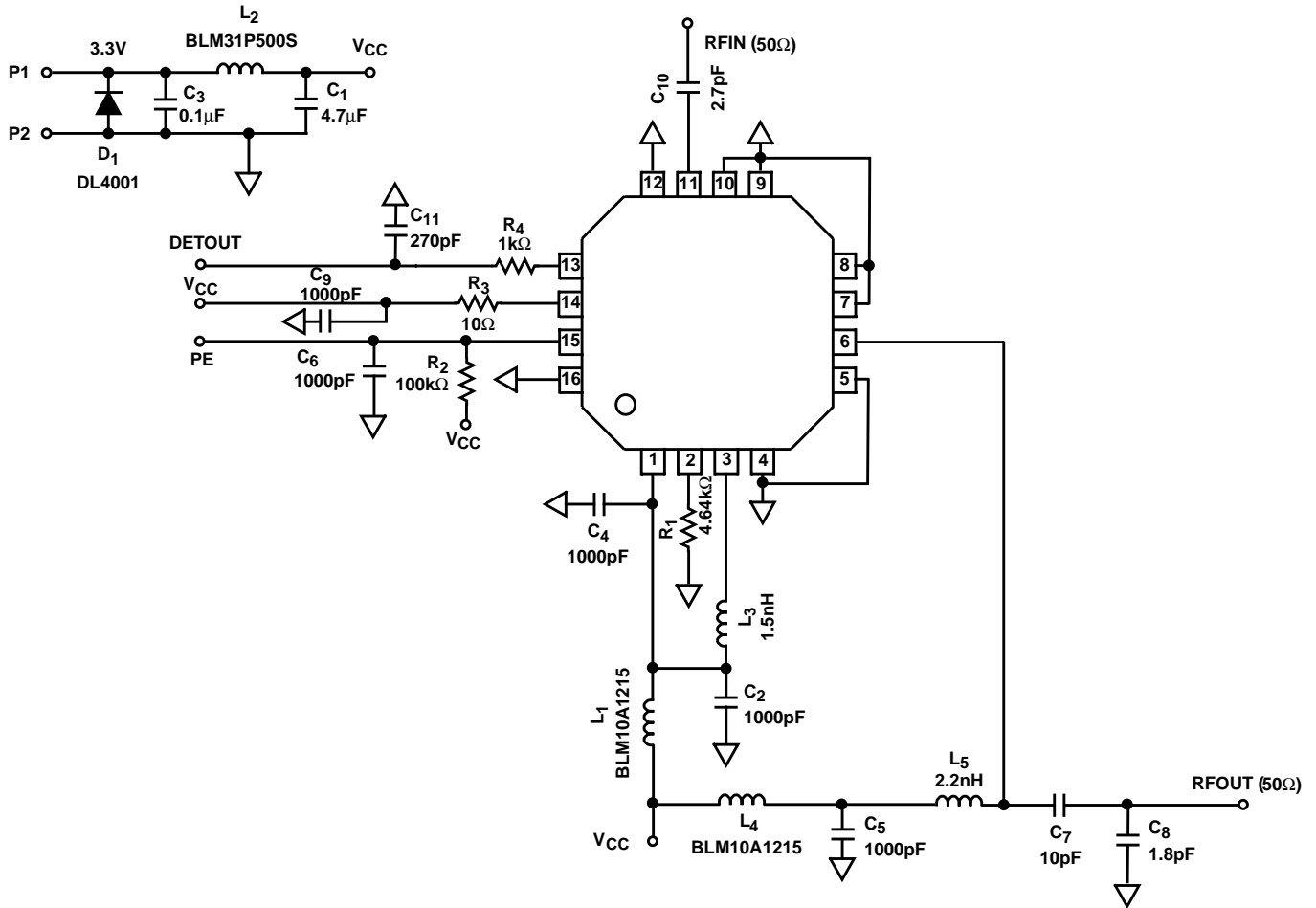

Typical Performance Curves

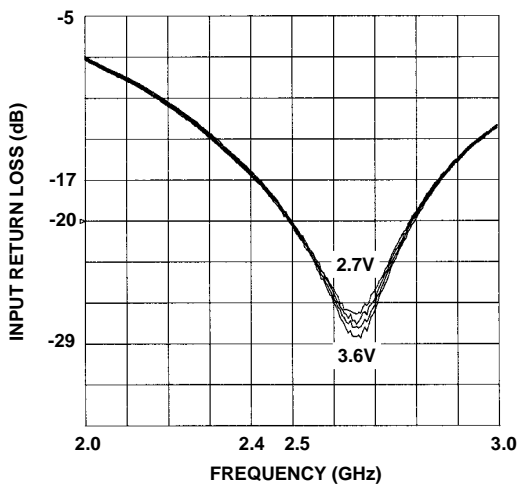

FIGURE 1. INPUT RETURN LOSS OVER VOLTAGE

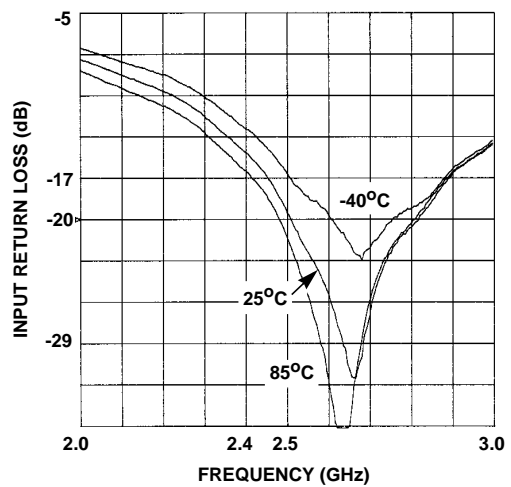

FIGURE 2. INPUT RETURN LOSS OVER TEMPERATURE

Typical Performance Curves (Continued)

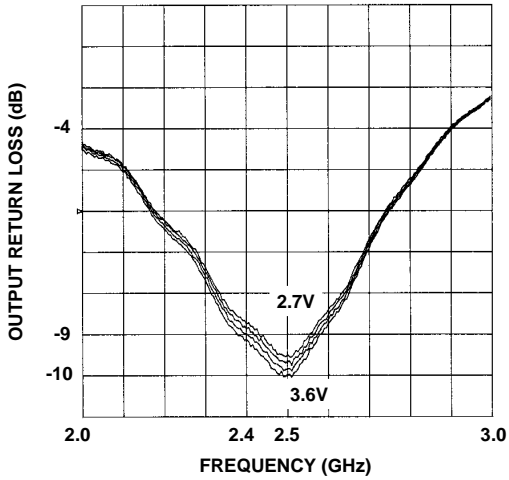

FIGURE 3. OUTPUT RETURN LOSS OVER VOLTAGE

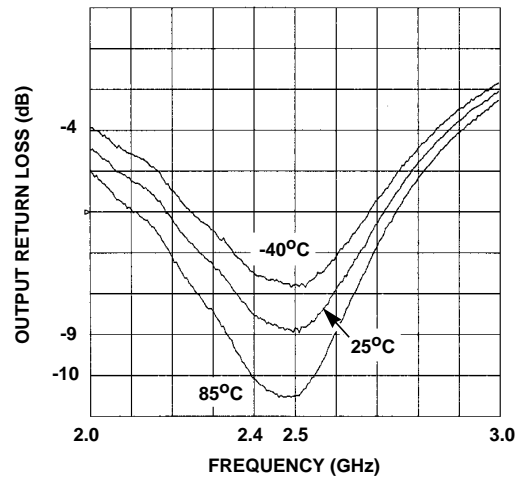

FIGURE 4. OUTPUT RETURN LOSS OVER TEMPERATURE

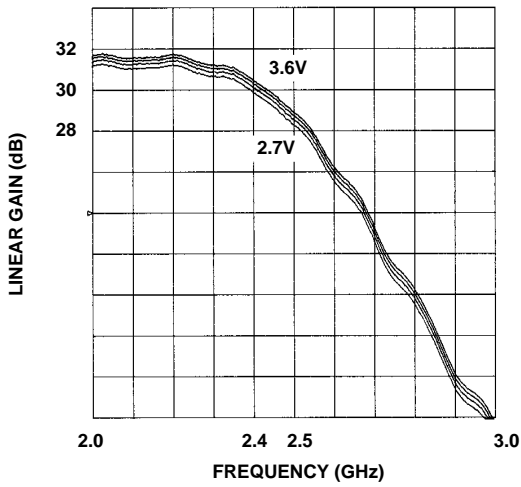

FIGURE 5. LINEAR GAIN OVER VOLTAGE

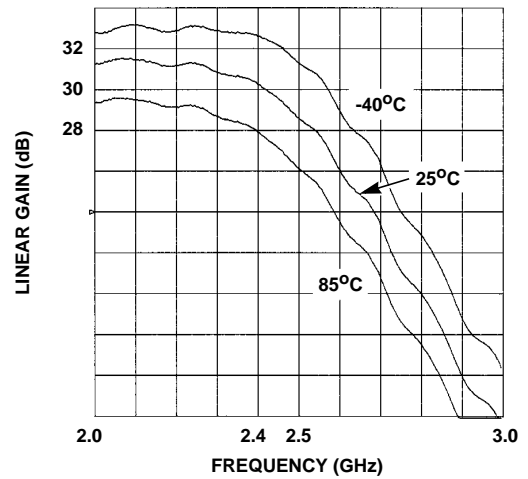

FIGURE 6. LINEAR GAIN OVER TEMPERATURE

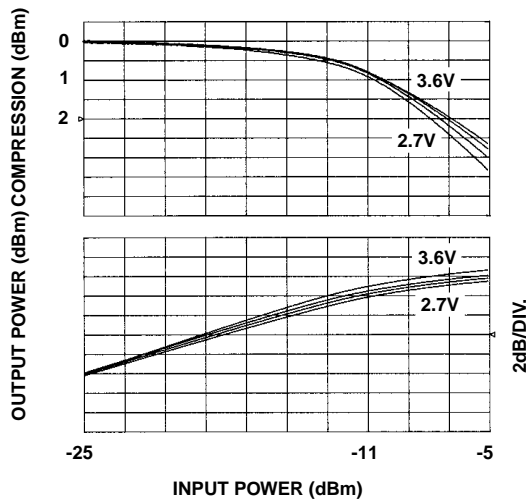

FIGURE 7. GAIN COMPRESSION OVER VOLTAGE

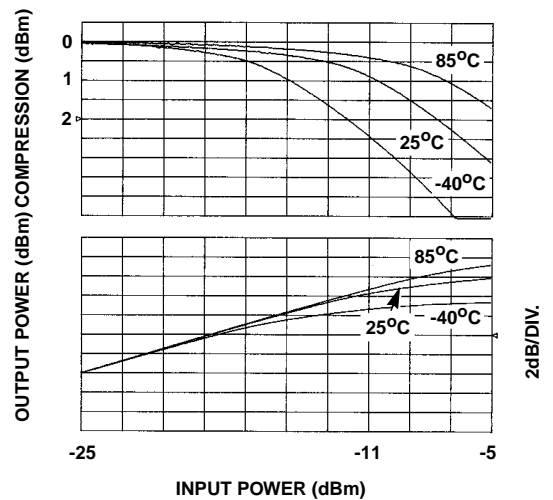

FIGURE 8. GAIN COMPRESSION OVER TEMPERATURE

Typical Performance Curves (Continued)

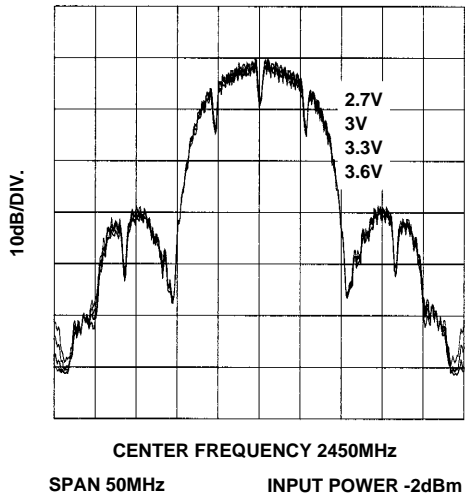

FIGURE 9. DSSS OUTPUT SIGNAL OVER VOLTAGE

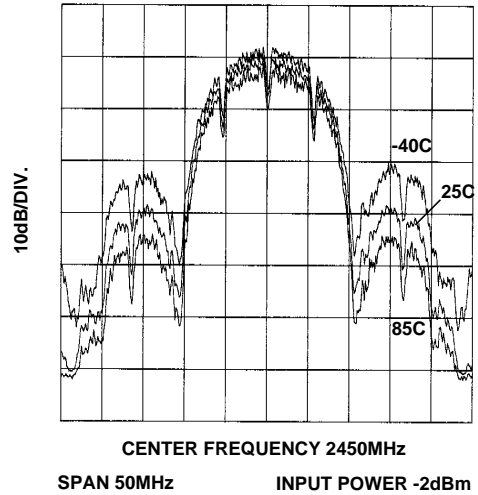

FIGURE 10. DSSS OUTPUT SIGNAL OVER TEMPERATURE

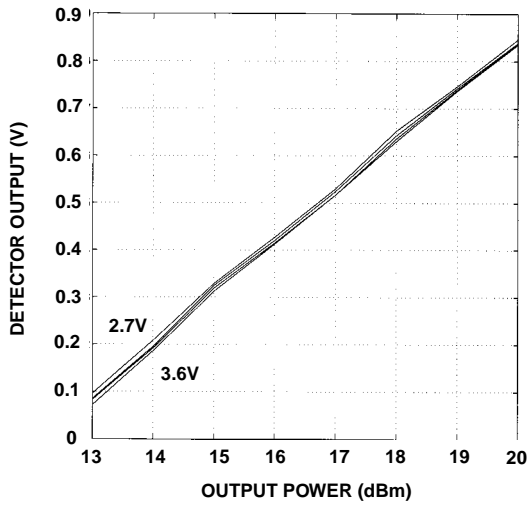

FIGURE 11. DETECTOR OUTPUT OVER VOLTAGE

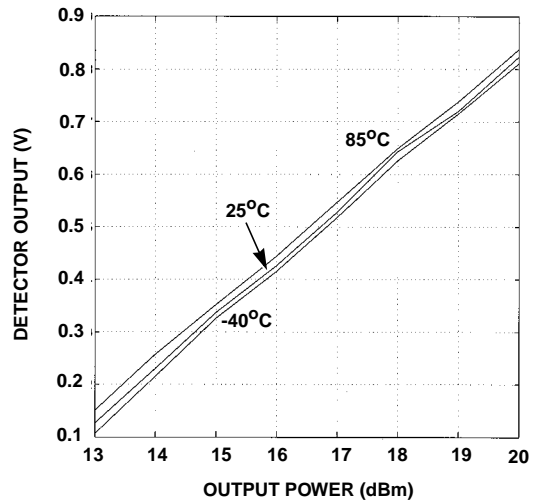
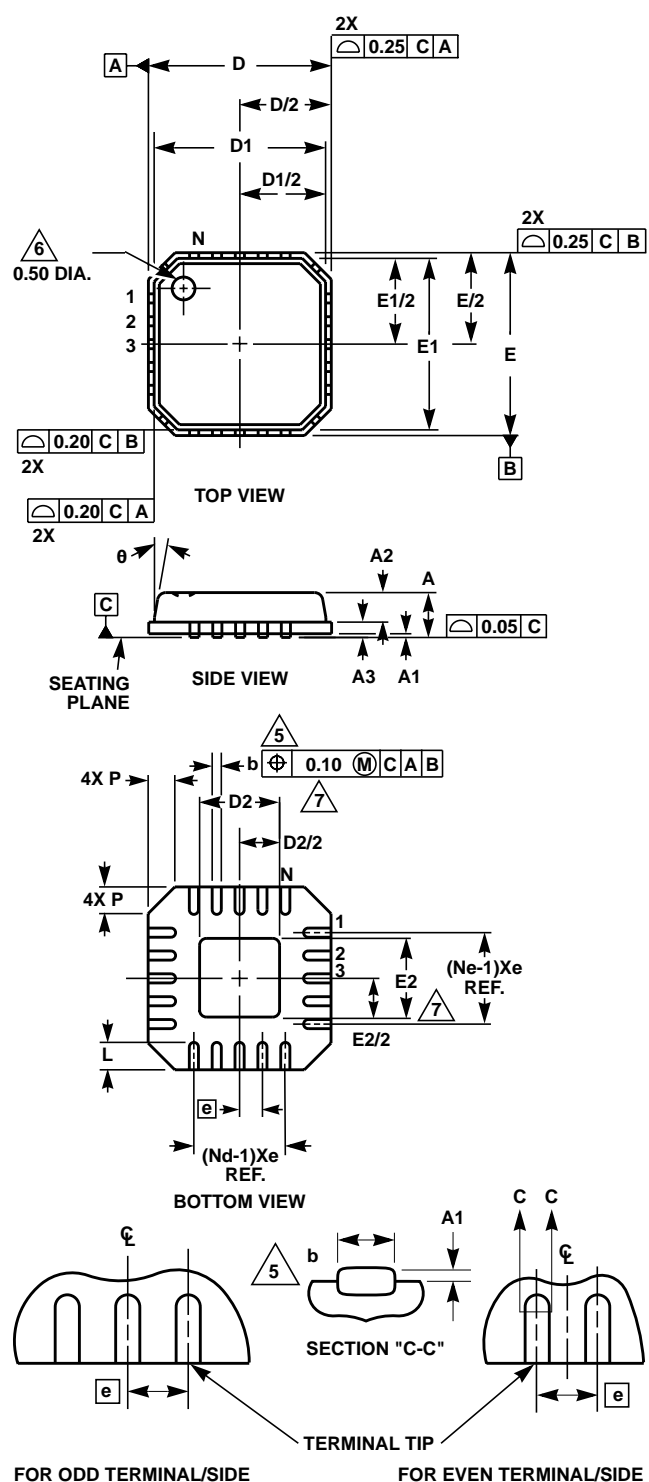

FIGURE 12. DETECTOR OUTPUT OVER TEMPERATURE

Micro Lead Frame Plastic Package (MLFP)



L16.4x4
16 LEAD MICRO LEAD FRAME PLASTIC PACKAGE
(COMPLIANT TO JEDEC MO-220-VGGC ISSUE A)

SYMBOL	INCHES		MILLIMETERS		NOTES
	MIN	MAX	MIN	MAX	
A	-	0.039	-	1.00	
A1	-	0.002	-	0.05	
A2	-	0.031	-	0.80	
A3	0.008 REF		0.20 REF		
b	0.009	0.014	0.23	0.35	5
D	0.157 BSC		4.00 BSC		
D1	0.147 BSC		3.75 BSC		
D2	-	0.088	-	2.25	7
E	0.157 BSC		4.00 BSC		
E1	0.147 BSC		3.75 BSC		
E2	-	0.088	-	2.25	7
e	0.026 BSC		0.65 BSC		
L	0.019	0.029	0.50	0.75	
N	16		16		2
Nd	4		4		3
Ne	4		4		3
P	0.009	0.024	0.24	0.60	
θ	-	12	-	12	

Rev. 2 8/00

NOTES:

1. Dimensioning and tolerancing per ASME Y14.5-1994.
2. N is the number of terminals.
3. Nd is the number of terminals in the X direction, and Ne is the number of terminals in the Y direction.
4. Controlling dimension: Millimeters. Converted dimensions to inches are not necessarily exact. Angles are in degrees.
5. Dimension b applies to the plated terminal and is measured between 0.20mm and 0.25mm from the terminal tip.
6. The Pin #1 identifier exists on the top surface as an indentation mark in the molded body.
7. Dimensions D2 and E2 are the maximum exposed pad dimensions for improved grounding and thermal performance.

All Intersil products are manufactured, assembled and tested utilizing ISO9000 quality systems.

Intersil Corporation's quality certifications can be viewed at website www.intersil.com/quality/iso.asp.

Intersil products are sold by description only. Intersil Corporation reserves the right to make changes in circuit design and/or specifications at any time without notice. Accordingly, the reader is cautioned to verify that data sheets are current before placing orders. Information furnished by Intersil is believed to be accurate and reliable. However, no responsibility is assumed by Intersil or its subsidiaries for its use; nor for any infringements of patents or other rights of third parties which may result from its use. No license is granted by implication or otherwise under any patent or patent rights of Intersil or its subsidiaries.

For information regarding Intersil Corporation and its products, see web site www.intersil.com