

IXYS

Advanced Technical Information

Power MOSFETs Q-Class

IXTH 28N50Q
IXTT 28N50Q

V_{DSS} = 500 V
I_{D25} = 28 A
R_{DS(on)} = 0.20 Ω

N-Channel Enhancement Mode
Avalanche Rated, Low Q_g, High dv/dt

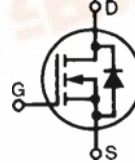

Symbol	Test Conditions	Maximum Ratings	
V _{DSS}	T _J = 25°C to 150°C	500	V
V _{DGR}	T _J = 25°C to 150°C; R _{GS} = 1 MΩ	500	V
V _{GS}	Continuous	±30	V
V _{GSM}	Transient	±40	V
I _{D25}	T _C = 25°C	28	A
I _{DM}	T _C = 25°C, pulse width limited by T _{JM}	112	A
I _{AR}	T _C = 25°C	28	A
E _{AR}	T _C = 25°C	40	mJ
E _{AS}		1.5	J
dv/dt	I _S ≤ I _{DM} , di/dt ≤ 100 A/μs, V _{DD} ≤ V _{DSS} , T _J ≤ 150°C, R _G = 2 Ω	10	V/ns
P _D	T _C = 25°C	400	W
T _J		-55 to +150	°C
T _{JM}		150	°C
T _{stg}		-55 to +150	°C
T _L	1.6 mm (0.063 in) from case for 10 s	300	°C
M _d	Mounting torque	1.13/10	Nm/lb.in.
Weight	TO-247	6	g
	TO-268	4	g

TO-247 AD (IXTH)

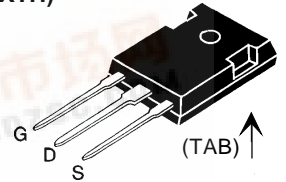

TO-268 (D3) (IXTT)

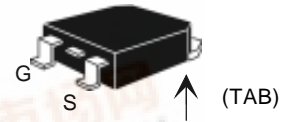

G = Gate D = Drain
S = Source TAB = Drain

Features

- IXYS advanced low Q_g process
- Low gate charge and capacitances
 - easier to drive
 - faster switching
- International standard packages
- Low R_{DS(on)}
- Rated for unclamped Inductive load switching (UIS) rated
- Molding epoxies meet UL 94 V-0 flammability classification

Advantages

- Easy to mount
- Space savings
- High power density

Symbol	Test Conditions	Characteristic Values (T _J = 25°C, unless otherwise specified)		
		min.	typ.	max.
V _{DSS}	V _{GS} = 0 V, I _D = 250 μA	500		V
V _{GS(th)}	V _{DS} = V _{GS} , I _D = 250 μA	2.5		V
I _{GSS}	V _{GS} = ±30 V _{DC} , V _{DS} = 0			±100 nA
I _{DSS}	V _{DS} = V _{DSS} V _{GS} = 0 V	T _J = 25°C		25 μA
		T _J = 125°C		1 mA
R _{DS(on)}	V _{GS} = 10 V, I _D = 0.5 I _{D25} Pulse test, t ≤ 300 μs, duty cycle d ≤ 2 %			0.20 Ω



Symbol	Test Conditions	Characteristic Values ($T_j = 25^\circ\text{C}$, unless otherwise specified)		
		min.	typ.	max.
g_{fs}	$V_{DS} = 20\text{ V}; I_D = 0.5 \cdot I_{D25}$, pulse test	16	28	S
C_{iss}	$V_{GS} = 0\text{ V}, V_{DS} = 25\text{ V}, f = 1\text{ MHz}$		3300	pF
C_{oss}			480	pF
C_{rss}			125	pF
$t_{d(on)}$	$V_{GS} = 10\text{ V}, V_{DS} = 0.5 \cdot V_{DSS}, I_D = 0.5 \cdot I_{D25}$ $R_G = 2.0\ \Omega$ (External),		17	ns
t_r			20	ns
$t_{d(off)}$			51	ns
t_f			12	ns
$Q_{g(on)}$	$V_{GS} = 10\text{ V}, V_{DS} = 0.5 \cdot V_{DSS}, I_D = 0.5 \cdot I_{D25}$		94	nC
Q_{gs}			20	nC
Q_{gd}			42	nC
R_{thJC}	(TO-247)			0.31 K/W
R_{thCK}			0.25	K/W

Symbol	Test Conditions	Characteristic Values ($T_j = 25^\circ\text{C}$, unless otherwise specified)		
		min.	typ.	max.
I_s	$V_{GS} = 0\text{ V}$			28 A
I_{SM}	Repetitive; pulse width limited by T_{JM}			112 A
V_{SD}	$I_F = I_s, V_{GS} = 0\text{ V}$, Pulse test, $t \leq 300\ \mu\text{s}$, duty cycle $d \leq 2\%$			1.5 V
t_{rr}	$I_F = I_s, -di/dt = 100\text{ A}/\mu\text{s}, V_R = 100\text{ V}$		500	ns
Q_{RM}			8.0	μC

TO-247 AD (IXFH) Outline

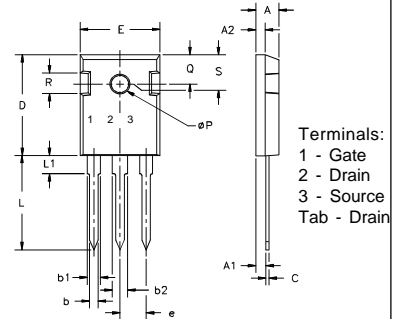

Terminals:
1 - Gate
2 - Drain
3 - Source
Tab - Drain

Dim.	Millimeter		Inches	
	Min.	Max.	Min.	Max.
A	4.7	5.3	.185	.209
A ₁	2.2	2.54	.087	.102
A ₂	2.2	2.6	.059	.098
b	1.0	1.4	.040	.055
b ₁	1.65	2.13	.065	.084
b ₂	2.87	3.12	.113	.123
C	.4	.8	.016	.031
D	20.80	21.46	.819	.845
E	15.75	16.26	.610	.640
e	5.20	5.72	0.205	0.225
L	19.81	20.32	.780	.800
L1		4.50		.177
∅P	3.55	3.65	.140	.144
Q	5.89	6.40	0.232	0.252
R	4.32	5.49	.170	.216
S	6.15	BSC	.242	BSC

TO-268 Outline

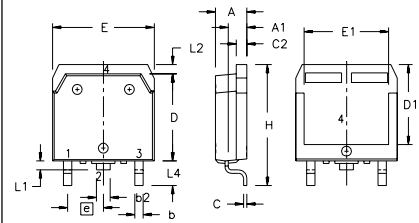

Terminals: 1 - Gate
2 - Drain
3 - Source
Tab - Drain

SYM	INCHES		MILLIMETERS	
	MIN	MAX	MIN	MAX
A	.193	.201	4.90	5.10
A1	.106	.114	2.70	2.90
A2	.001	.010	0.02	0.25
b	.045	.057	1.15	1.45
b2	.075	.083	1.90	2.10
C	.016	.026	0.40	0.65
C2	.057	.063	1.45	1.60
D	5.43	5.51	13.80	14.00
D1	.488	.500	12.40	12.70
E	6.24	6.32	15.85	16.05
E1	5.24	5.35	13.30	13.60
e		.215 BSC		5.45 BSC
H	.736	.752	18.70	19.10
L	.094	.106	2.40	2.70
L1	.047	.055	1.20	1.40
L2	.039	.045	1.00	1.15
L3		.010 BSC		0.25 BSC
L4	.150	.161	3.80	4.10

Fig. 1. Output Characteristics
@ 25 Deg. C

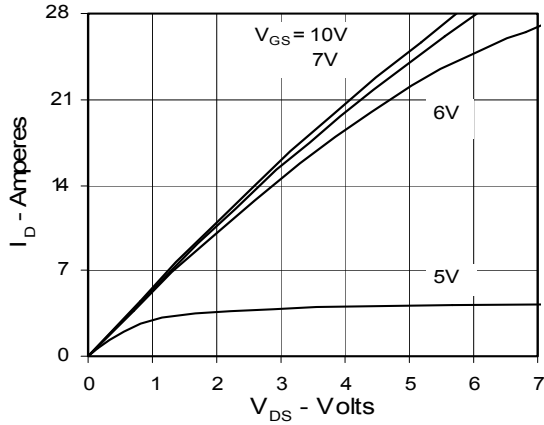

Fig. 2. Extended Output Characteristics
@ 25 deg. C

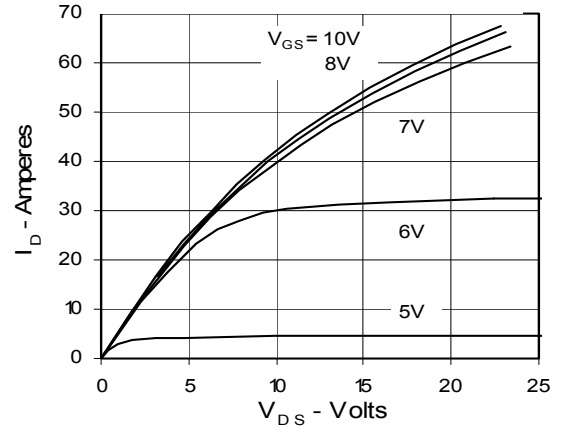

Fig. 3. Output Characteristics
@ 125 Deg. C

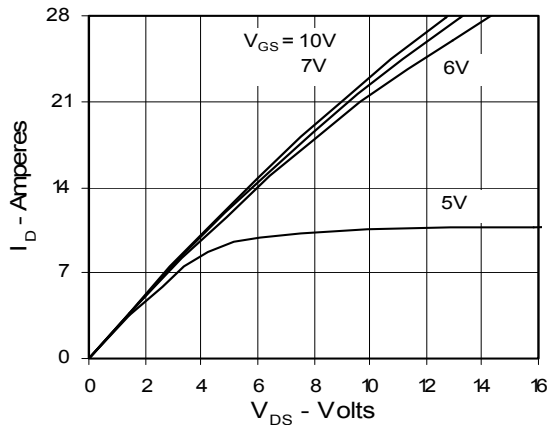

Fig. 4. $R_{DS(on)}$ Normalized to I_{D25} Value vs. Junction Temperature

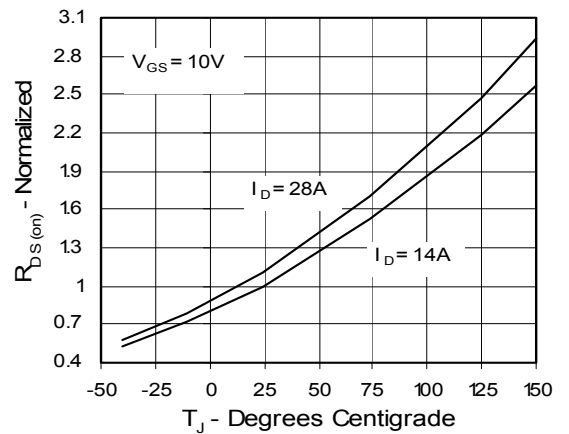

Fig. 5. $R_{DS(on)}$ Normalized to I_{D25} Value vs. I_D

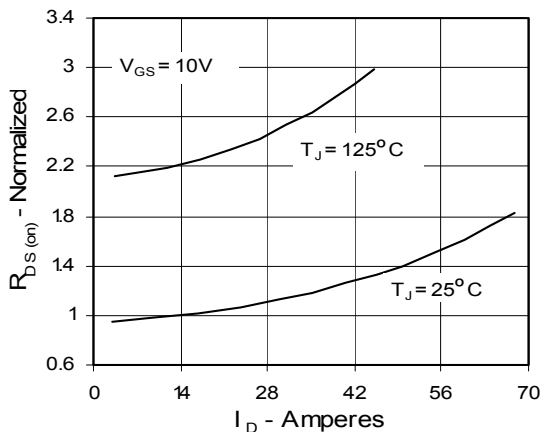

Fig. 6. Drain Current vs. Case Temperature

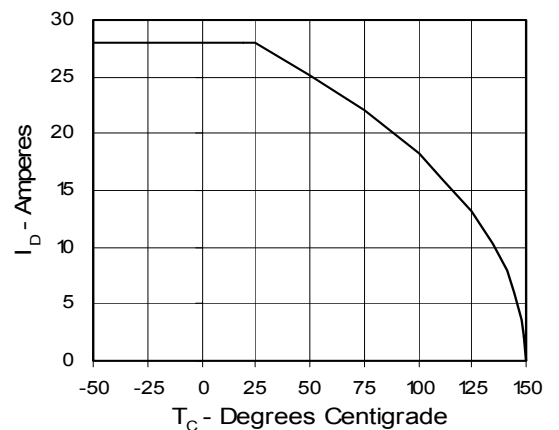

Fig. 7. Input Admittance

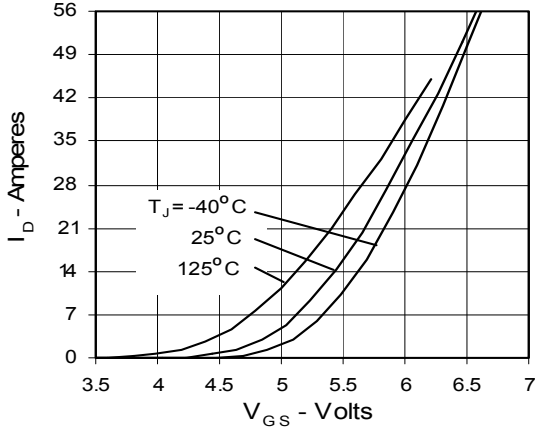

Fig. 8. Transconductance

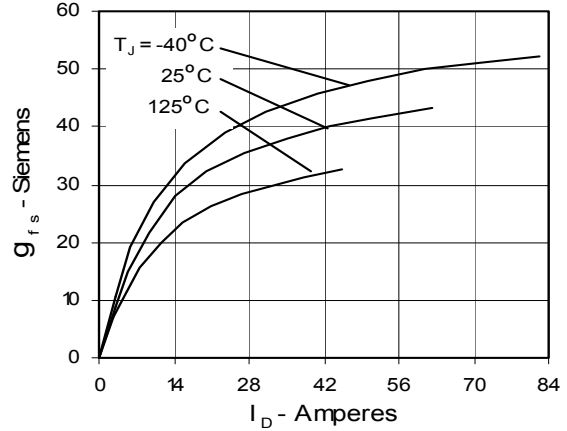

Fig. 9. Source Current vs. Source-To-Drain Voltage

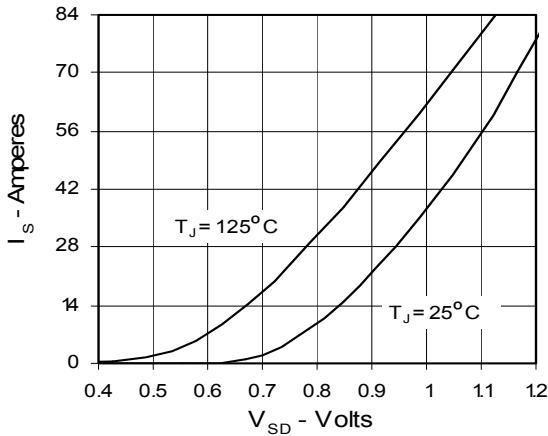

Fig. 10. Gate Charge

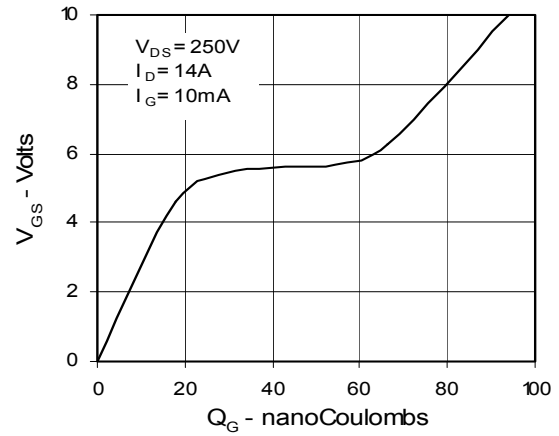

Fig. 11. Capacitance

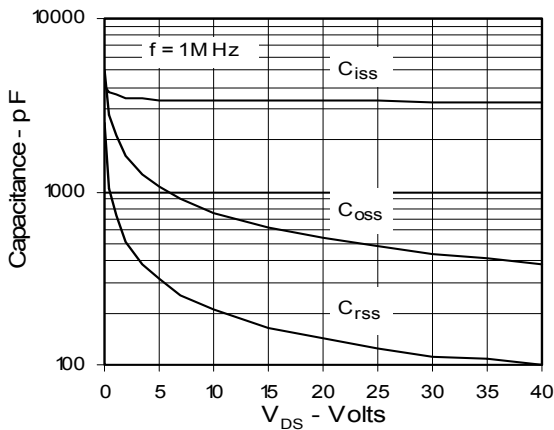

Fig. 12. Maximum Transient Thermal Resistance

