

## HIGH VOLTAGE MEDIUM CURRENT DRIVER ARRAYS

### DESCRIPTION

The SG2800 series integrates eight NPN Darlington pairs with internal suppression diodes to drive lamps, relays, and solenoids in many military, aerospace, and industrial applications that require severe environments. All units feature open collector outputs with greater than 50V breakdown voltages combined with 500mA current carrying capabilities. Five different input configurations provide optimized designs for interfacing with DTL, TTL, PMOS, or CMOS drive signals. These devices are designed to operate from -55°C to 125°C ambient temperature in a 18-pin dual in-line ceramic (J) package and 20-pin leadless chip carrier (LCC).

### FEATURES

- Eight NPN Darlington pairs
- Collector currents to 600mA
- Output voltages from 50V to 95V
- Internal clamping diodes for inductive loads
- DTL, TTL, PMOS, or CMOS compatible inputs
- Hermetic ceramic package

### HIGH RELIABILITY FEATURES

- ◆ Available to MIL-STD-883 and DESC SMD
- ◆ MIL-M38510/14106BVA - JAN2801J
- ◆ MIL-M38510/14107BVA - JAN2802J
- ◆ MIL-M38510/14108BVA - JAN2803J
- ◆ MIL-M38510/14109BVA - JAN2804J
- ◆ Radiation data available
- ◆ LMI level "S" processing available

### PARTIAL SCHEMATICS

SG2801/2811/2821

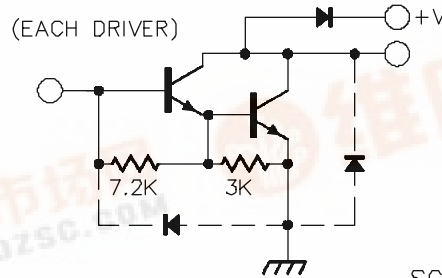

SG2802/2812

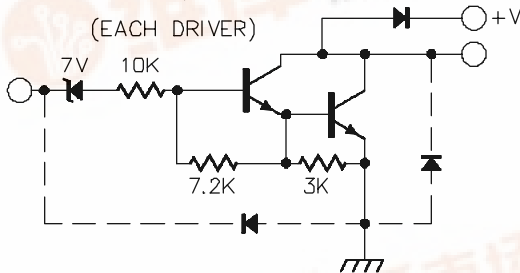

SG2803/2813/2823

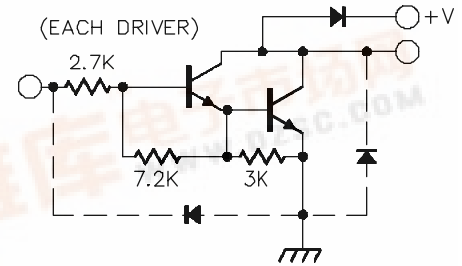

SG2804/2814/2824

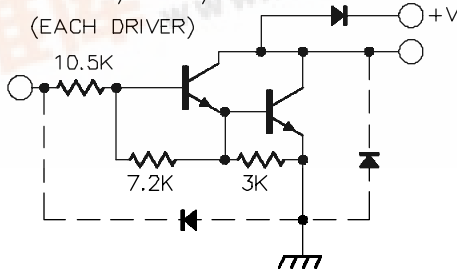

SG2805/2815

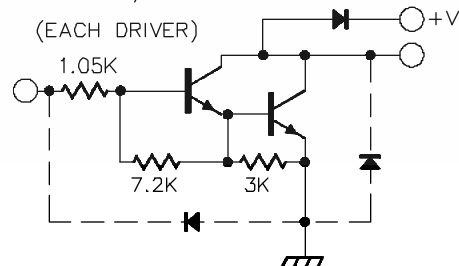

# SG2800 SERIES

## ABSOLUTE MAXIMUM RATINGS (Note 1)

Output Voltage, $V_{CE}$	
(SG2800, 2810 series) .....	50V
(SG2820 series) .....	95V
Input Voltage, $V_{IN}$	
(SG2802,3,4 series) .....	30V
Continuous Input Current, $I_{IN}$ .....	25mA

Note 1. Values beyond which damage may occur.

Continuous Collector Current, $I_C$	
(SG2800, 2820) .....	500mA
(SG2810) .....	600mA
Operating Junction Temperature	
Hermetic (J, L Packages) .....	150°C
Plastic (N Package) .....	150°C
Storage Temperature Range .....	-65°C to 150°C
Lead Temperature (Soldering 10 sec.) .....	300°C

## THERMAL DATA

J Package:

Thermal Resistance-Junction to Case, $\theta_{JC}$ .....	25°C/W
Thermal Resistance-Junction to Ambient, $\theta_{JA}$ .....	70°C/W

N Package:

Thermal Resistance-Junction to Case, $\theta_{JC}$ .....	30°C/W
Thermal Resistance-Junction to Ambient, $\theta_{JA}$ .....	60°C/W

L Package:

Thermal Resistance-Junction to Case, $\theta_{JC}$ .....	35°C/W
Thermal Resistance-Junction to Ambient, $\theta_{JA}$ .....	120°C/W

Note A. Junction Temperature Calculation:  $T_J = T_A + (P_D \times \theta_{JA})$ .

Note B. The above numbers for  $\theta_{JC}$  are maximums for the limiting thermal resistance of the package in a standard mounting configuration. The  $\theta_{JA}$  numbers are meant to be guidelines for the thermal performance of the device/pc-board system. All of the above assume no ambient airflow.

## RECOMMENDED OPERATING CONDITIONS (Note 2)

Output Voltage, $V_{CE}$	
SG2800, SG2820 series .....	50V
SG2810 series .....	95V

Note 2. Range over which the device is functional.

Peak Collector Current, $I_C$	
SG2800, SG2820 series .....	350mA
SG2810 series .....	500mA
Operating Ambient Temperature Range .....	-55°C to 125°C

## SELECTION GUIDE

Device	$V_{CE}$ Max	$I_C$ Max	Logic Inputs
SG2801	50V	500mA	General Purpose PMOS, CMOS
SG2802	50V	500mA	14V-25V PMOS
SG2803	50V	500mA	5V TTL, CMOS
SG2804	50V	500mA	6V-15V CMOS, PMOS
SG2811	50V	600mA	General Purpose PMOS, CMOS
SG2812	50V	600mA	14V-25V PMOS

Device	$V_{CE}$ Max	$I_C$ Max	Logic Inputs
SG2813	50V	600mA	5V TTL, CMOS
SG2814	50V	600mA	6V-15V CMOS, PMOS
SG2815	50V	600mA	High Output TTL
SG2821	95V	500mA	General Purpose PMOS, CMOS
SG2823	95V	500mA	5V TTL, CMOS
SG2824	95V	500mA	6V-15V CMOS, PMOS

# SG2800 SERIES

## ELECTRICAL CHARACTERISTICS

(Unless otherwise specified, these specifications apply over the operating ambient temperatures of  $-55^{\circ}\text{C} \leq T_A \leq 125^{\circ}\text{C}$ . Low duty cycle pulse testing techniques are used which maintains junction and case temperatures equal to the ambient temperature.)

SG2801 thru SG2804

Parameter	Applicable Devices	Temp.	Test Conditions	Limits			Units
				Min.	Typ.	Max.	
Output Leakage Current ( $I_{\text{CEX}}$ )	All		$V_{\text{CE}} = 50\text{V}$			100	$\mu\text{A}$
	SG2802		$V_{\text{CE}} = 50\text{V}, V_{\text{IN}} = 6\text{V}$			500	$\mu\text{A}$
	SG2804		$V_{\text{CE}} = 50\text{V}, V_{\text{IN}} = 1\text{V}$			500	$\mu\text{A}$
Collector - Emitter ( $V_{\text{CE(SAT)}}$ )	All	$T_A = T_{\text{MIN}}$	$I_C = 350\text{mA}, I_B = 850\mu\text{A}$	1.6	1.8		V
		$T_A = T_{\text{MIN}}$	$I_C = 200\text{mA}, I_B = 550\mu\text{A}$	1.3	1.5		V
		$T_A = T_{\text{MIN}}$	$I_C = 100\text{mA}, I_B = 350\mu\text{A}$	1.1	1.3		V
		$T_A = 25^{\circ}\text{C}$	$I_C = 350\text{mA}, I_B = 500\mu\text{A}$	1.25	1.6		V
		$T_A = 25^{\circ}\text{C}$	$I_C = 200\text{mA}, I_B = 350\mu\text{A}$	1.1	1.3		V
		$T_A = 25^{\circ}\text{C}$	$I_C = 100\text{mA}, I_B = 250\mu\text{A}$	0.9	1.1		V
		$T_A = T_{\text{MAX}}$	$I_C = 350\text{mA}, I_B = 500\mu\text{A}$	1.6	1.8		V
		$T_A = T_{\text{MAX}}$	$I_C = 200\text{mA}, I_B = 350\mu\text{A}$	1.3	1.5		V
Input Current ( $I_{\text{IN(ON)}}$ )	SG2802		$V_{\text{IN}} = 17\text{V}$	480	850	1300	$\mu\text{A}$
	SG2803		$V_{\text{IN}} = 3.85\text{V}$	650	930	1350	$\mu\text{A}$
	SG2804		$V_{\text{IN}} = 5\text{V}$	240	350	500	$\mu\text{A}$
			$V_{\text{IN}} = 12\text{V}$	650	1000	1450	$\mu\text{A}$
$I_{\text{IN(OFF)}}$	All	$T_A = T_{\text{MAX}}$	$I_C = 500\mu\text{A}$	25	50		$\mu\text{A}$
Input Voltage ( $V_{\text{IN(ON)}}$ )	SG2802	$T_A = T_{\text{MIN}}$	$V_{\text{CE}} = 2\text{V}, I_C = 300\text{mA}$			18	V
		$T_A = T_{\text{MAX}}$	$V_{\text{CE}} = 2\text{V}, I_C = 300\text{mA}$			13	V
	SG2803	$T_A = T_{\text{MIN}}$	$V_{\text{CE}} = 2\text{V}, I_C = 200\text{mA}$			3.3	V
		$T_A = T_{\text{MIN}}$	$V_{\text{CE}} = 2\text{V}, I_C = 250\text{mA}$			3.6	V
		$T_A = T_{\text{MIN}}$	$V_{\text{CE}} = 2\text{V}, I_C = 300\text{mA}$			3.9	V
		$T_A = T_{\text{MAX}}$	$V_{\text{CE}} = 2\text{V}, I_C = 200\text{mA}$			2.4	V
	SG2804	$T_A = T_{\text{MAX}}$	$V_{\text{CE}} = 2\text{V}, I_C = 250\text{mA}$			2.7	V
		$T_A = T_{\text{MAX}}$	$V_{\text{CE}} = 2\text{V}, I_C = 300\text{mA}$			3.0	V
		$T_A = T_{\text{MIN}}$	$V_{\text{CE}} = 2\text{V}, I_C = 125\text{mA}$			6.0	V
		$T_A = T_{\text{MIN}}$	$V_{\text{CE}} = 2\text{V}, I_C = 200\text{mA}$			8.0	V
		$T_A = T_{\text{MIN}}$	$V_{\text{CE}} = 2\text{V}, I_C = 275\text{mA}$			10	V
		$T_A = T_{\text{MIN}}$	$V_{\text{CE}} = 2\text{V}, I_C = 350\text{mA}$			12	V
		$T_A = T_{\text{MAX}}$	$V_{\text{CE}} = 2\text{V}, I_C = 125\text{mA}$			5.0	V
		$T_A = T_{\text{MAX}}$	$V_{\text{CE}} = 2\text{V}, I_C = 200\text{mA}$			6.0	V
		$T_A = T_{\text{MAX}}$	$V_{\text{CE}} = 2\text{V}, I_C = 275\text{mA}$			7.0	V
		$T_A = T_{\text{MAX}}$	$V_{\text{CE}} = 2\text{V}, I_C = 350\text{mA}$			8.0	V
D-C Forward Current Transfer Ratio ( $h_{\text{FE}}$ )	SG2801	$T_A = T_{\text{MIN}}$	$V_{\text{CE}} = 2\text{V}, I_C = 350\text{mA}$	500			
		$T_A = 25^{\circ}\text{C}$	$V_{\text{CE}} = 2\text{V}, I_C = 350\text{mA}$	1000			
Input Capacitance ( $C_{\text{IN}}$ ) (Note 3)	All	$T_A = 25^{\circ}\text{C}$		15	25		pF
Turn-On Delay (TPLH)	All	$T_A = 25^{\circ}\text{C}$	$0.5 E_{\text{IN}}$ to $0.5 E_{\text{OUT}}$	250	1000		ns
Turn-Off Delay (TPHL)	All	$T_A = 25^{\circ}\text{C}$	$0.5 E_{\text{IN}}$ to $0.5 E_{\text{OUT}}$	250	1000		ns
Clamp Diode Leakage Current ( $I_{\text{R}}$ )	All		$V_{\text{R}} = 50\text{V}$			50	$\mu\text{A}$
Clamp Diode Forward Voltage ( $V_{\text{F}}$ )	All		$I_{\text{F}} = 350\text{mA}$	1.7	2.0		V

Note 3. These parameters, although guaranteed, are not tested in production.

# SG2800 SERIES

## ELECTRICAL CHARACTERISTICS (continued)

SG2811 thru SG2815

Parameter	Applicable Devices	Temp.	Test Conditions	Limits			Units
				Min.	Typ.	Max.	
Output Leakage Current ( $I_{CEX}$ )	All		$V_{CE} = 50V$			100	$\mu A$
	SG2812		$V_{CE} = 50V, V_{IN} = 6V$			500	$\mu A$
	SG2814		$V_{CE} = 50V, V_{IN} = 1V$			500	$\mu A$
Collector - Emitter ( $V_{CE(SAT)}$ )	All	$T_A = T_{MIN}$	$I_C = 500mA, I_B = 1100\mu A$		1.8	2.1	V
		$T_A = T_{MIN}$	$I_C = 350mA, I_B = 850\mu A$		1.6	1.8	V
		$T_A = T_{MIN}$	$I_C = 200mA, I_B = 550\mu A$		1.3	1.5	V
		$T_A = 25^\circ C$	$I_C = 500mA, I_B = 600\mu A$		1.7	1.9	V
		$T_A = 25^\circ C$	$I_C = 350mA, I_B = 500\mu A$		1.25	1.6	V
		$T_A = 25^\circ C$	$I_C = 200mA, I_B = 350\mu A$		1.1	1.3	V
		$T_A = T_{MAX}$	$I_C = 500mA, I_B = 600\mu A$		1.8	2.1	V
		$T_A = T_{MAX}$	$I_C = 350mA, I_B = 500\mu A$		1.6	1.8	V
		$T_A = T_{MAX}$	$I_C = 200mA, I_B = 350\mu A$		1.3	1.5	V
Input Current ( $I_{IN(ON)}$ )	SG2812		$V_{IN} = 17V$	480	850	1300	$\mu A$
	SG2813		$V_{IN} = 3.85V$	650	930	1350	$\mu A$
	SG2814		$V_{IN} = 5V$	240	350	500	$\mu A$
	SG2815		$V_{IN} = 12V$	650	1000	1450	$\mu A$
			$V_{IN} = 3V$	1180	1500	2400	$\mu A$
Input Voltage ( $V_{IN(ON)}$ )	All	$T_A = T_{MAX}$	$I_C = 500\mu A$	25	50		$\mu A$
	SG2812	$T_A = T_{MIN}$	$V_{CE} = 2V, I_C = 500mA$			23.5	V
Input Voltage ( $V_{IN(ON)}$ )	SG2813	$T_A = T_{MAX}$	$V_{CE} = 2V, I_C = 500mA$			17	V
		$T_A = T_{MIN}$	$V_{CE} = 2V, I_C = 250mA$			3.6	V
		$T_A = T_{MIN}$	$V_{CE} = 2V, I_C = 300mA$			3.9	V
		$T_A = T_{MIN}$	$V_{CE} = 2V, I_C = 500mA$			6.0	V
		$T_A = T_{MAX}$	$V_{CE} = 2V, I_C = 250mA$			2.7	V
		$T_A = T_{MAX}$	$V_{CE} = 2V, I_C = 300mA$			3.0	V
	SG2814	$T_A = T_{MAX}$	$V_{CE} = 2V, I_C = 500mA$			3.5	V
		$T_A = T_{MIN}$	$V_{CE} = 2V, I_C = 275mA$			10	V
		$T_A = T_{MIN}$	$V_{CE} = 2V, I_C = 350mA$			12	V
		$T_A = T_{MIN}$	$V_{CE} = 2V, I_C = 500mA$			17	V
		$T_A = T_{MAX}$	$V_{CE} = 2V, I_C = 275mA$			7.0	V
		$T_A = T_{MAX}$	$V_{CE} = 2V, I_C = 350mA$			8.0	V
	SG2815	$T_A = T_{MAX}$	$V_{CE} = 2V, I_C = 500mA$			9.5	V
		$T_A = T_{MIN}$	$V_{CE} = 2V, I_C = 350mA$			3.0	V
		$T_A = T_{MIN}$	$V_{CE} = 2V, I_C = 500mA$			3.5	V
		$T_A = T_{MIN}$	$V_{CE} = 2V, I_C = 350mA$			2.4	V
		$T_A = T_{MAX}$	$V_{CE} = 2V, I_C = 500mA$			2.6	V
		$T_A = T_{MAX}$	$V_{CE} = 2V, I_C = 500mA$			900	
D-C Forward Current	SG2811	$T_A = T_{MIN}$	$V_{CE} = 2V, I_C = 500mA$	450			
Transfer Ratio ( $h_{FE}$ )		$T_A = 25^\circ C$	$V_{CE} = 2V, I_C = 500mA$				
Input Capacitance ( $C_{IN}$ ) (Note 3)	All	$T_A = 25^\circ C$			15	25	pF
Turn-On Delay (TPLH)	All	$T_A = 25^\circ C$	$0.5 E_{IN}$ to $0.5 E_{OUT}$	250	1000		ns
Turn-Off Delay (TPHL)	All	$T_A = 25^\circ C$	$0.5 E_{IN}$ to $0.5 E_{OUT}$	250	1000		ns
Clamp Diode Leakage Current ( $I_R$ )	All		$V_R = 50V$			50	$\mu A$
Clamp Diode Forward Voltage ( $V_F$ )	All		$I_F = 350mA$		1.7	2.0	V
			$I_F = 500mA$			2.5	V

Note 3. These parameters, although guaranteed, are not tested in production.

# SG2800 SERIES

## ELECTRICAL CHARACTERISTICS (continued)

SG2821 thru SG2824

Parameter	Applicable Devices	Temp.	Test Conditions	Limits			Units
				Min.	Typ.	Max.	
Output Leakage Current ( $I_{CEX}$ )	All		$V_{CE} = 95V$			100	$\mu A$
	SG2824		$V_{CE} = 95V, V_{IN} = 1V$			500	$\mu A$
Collector - Emitter ( $V_{CE(SAT)}$ )	All	$T_A = T_{MIN}$	$I_C = 350mA, I_B = 850\mu A$	1.6	1.8		V
		$T_A = T_{MIN}$	$I_C = 200mA, I_B = 550\mu A$	1.3	1.5		V
		$T_A = T_{MIN}$	$I_C = 100mA, I_B = 350\mu A$	1.1	1.3		V
		$T_A = 25^\circ C$	$I_C = 350mA, I_B = 500\mu A$	1.25	1.6		V
		$T_A = 25^\circ C$	$I_C = 200mA, I_B = 350\mu A$	1.1	1.3		V
		$T_A = 25^\circ C$	$I_C = 100mA, I_B = 250\mu A$	0.9	1.1		V
		$T_A = T_{MAX}$	$I_C = 350mA, I_B = 500\mu A$	1.6	1.8		V
		$T_A = T_{MAX}$	$I_C = 200mA, I_B = 350\mu A$	1.3	1.5		V
		$T_A = T_{MAX}$	$I_C = 100mA, I_B = 250\mu A$	1.1	1.3		V
Input Current ( $I_{IN(ON)}$ )	SG2823		$V_{IN} = 3.85V$	650	930	1350	$\mu A$
	SG2824		$V_{IN} = 5V$	240	350	500	$\mu A$
			$V_{IN} = 12V$	650	1000	1450	$\mu A$
	All	$T_A = T_{MAX}$	$I_C = 500\mu A$	25	50		$\mu A$
Input Voltage ( $V_{IN(ON)}$ )		$T_A = T_{MAX}$	$V_{CE} = 2V, I_C = 300mA$			13	V
	SG2823	$T_A = T_{MIN}$	$V_{CE} = 2V, I_C = 200mA$			3.3	V
		$T_A = T_{MIN}$	$V_{CE} = 2V, I_C = 250mA$			3.6	V
		$T_A = T_{MIN}$	$V_{CE} = 2V, I_C = 300mA$			3.9	V
		$T_A = T_{MAX}$	$V_{CE} = 2V, I_C = 200mA$			2.4	V
		$T_A = T_{MAX}$	$V_{CE} = 2V, I_C = 250mA$			2.7	V
		$T_A = T_{MAX}$	$V_{CE} = 2V, I_C = 300mA$			3.0	V
	SG2824	$T_A = T_{MIN}$	$V_{CE} = 2V, I_C = 125mA$			6.0	V
		$T_A = T_{MIN}$	$V_{CE} = 2V, I_C = 200mA$			8.0	V
		$T_A = T_{MIN}$	$V_{CE} = 2V, I_C = 275mA$			10	V
		$T_A = T_{MIN}$	$V_{CE} = 2V, I_C = 350mA$			12	V
		$T_A = T_{MAX}$	$V_{CE} = 2V, I_C = 125mA$			5.0	V
		$T_A = T_{MAX}$	$V_{CE} = 2V, I_C = 200mA$			6.0	V
		$T_A = T_{MAX}$	$V_{CE} = 2V, I_C = 275mA$			7.0	V
		$T_A = T_{MAX}$	$V_{CE} = 2V, I_C = 350mA$			8.0	V
D-C Forward Current	SG2821	$T_A = T_{MIN}$	$V_{CE} = 2V, I_C = 350mA$	500			
Transfer Ratio ( $h_{FE}$ )		$T_A = 25^\circ C$	$V_{CE} = 2V, I_C = 350mA$	1000			
Input Capacitance ( $C_{IN}$ ) (Note 3)	All	$T_A = 25^\circ C$			15	25	pF
Turn-On Delay (T <sub>PLH</sub> )	All	$T_A = 25^\circ C$	$0.5 E_{IN}$ to $0.5 E_{OUT}$	250	1000		ns
Turn-Off Delay (T <sub>PHL</sub> )	All	$T_A = 25^\circ C$	$0.5 E_{IN}$ to $0.5 E_{OUT}$	250	1000		ns
Clamp Diode Leakage Current ( $I_R$ )	All		$V_R = 95V$			50	$\mu A$
Clamp Diode Forward Voltage ( $V_F$ )	All		$I_F = 350mA$	1.7	2.0		V

Note 3. These parameters, although guaranteed, are not tested in production.

## CHARACTERISTIC CURVES

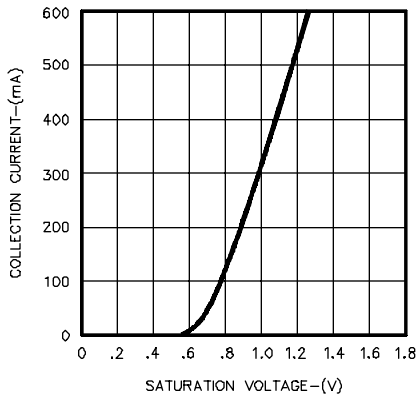

FIGURE 1.  
OUTPUT CHARACTERISTICS

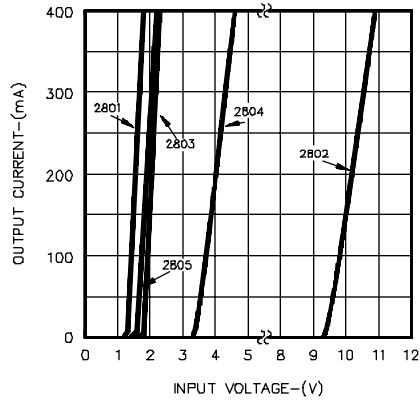

FIGURE 2.  
OUTPUT CURRENT VS. INPUT VOLTAGE

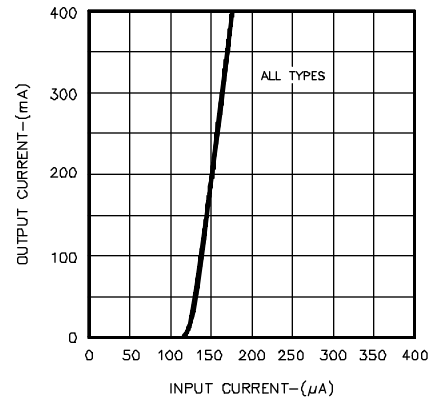

FIGURE 3.  
OUTPUT CURRENT VS. INPUT CURRENT

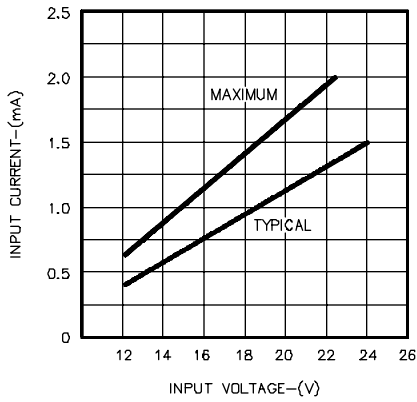

FIGURE 4.  
INPUT CHARACTERISTICS - SG2802

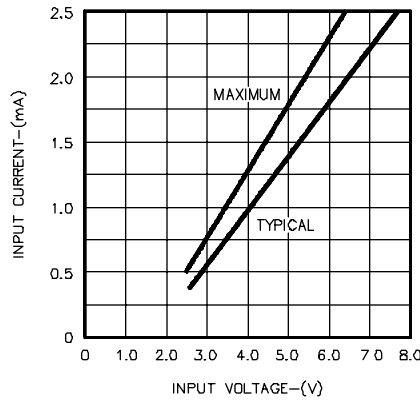

FIGURE 5.  
INPUT CHARACTERISTICS - SG2803

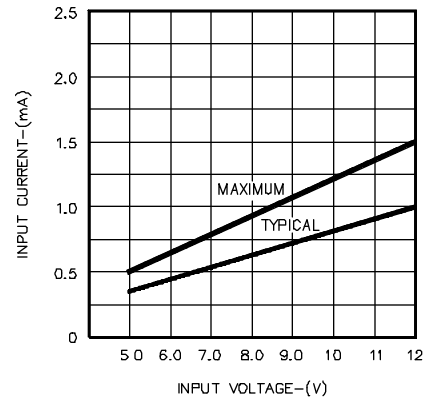

FIGURE 6.  
INPUT CHARACTERISTICS - SG2804

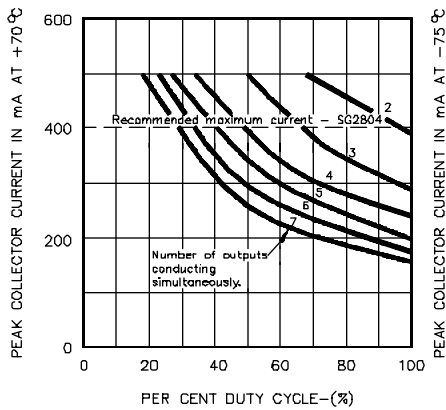
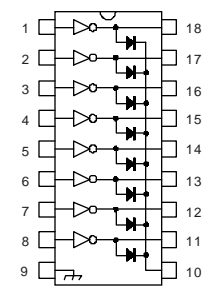
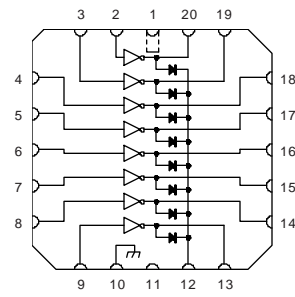

FIGURE 7.  
PEAK COLLECTOR CURRENT VS. DUTY CYCLE

# SG2800 SERIES

## CONNECTION DIAGRAMS & ORDERING INFORMATION (See Notes Below)

Package	Part No. (Note 3)	Ambient Temperature Range	Connection Diagram
18-PIN CERAMIC DIP J- PACKAGE	SG28XXJ/883B JAN2801J JAN2802J JAN2803J JAN2804J SG2803J/DESC SG2821J/DESC SG2823J/DESC SG2824J/DESC SG28XXJ	-55°C to 125°C -55°C to 125°C -55°C to 125°C -55°C to 125°C -55°C to 125°C -55°C to 125°C -55°C to 125°C -55°C to 125°C -55°C to 125°C	
18-PIN PLASTIC DIP N- PACKAGE	SG2803N SG2823N	0°C to 70°C 0°C to 70°C	
20-PIN CERAMIC LEADLESS CHIP CARRIER L- PACKAGE	SG28XXL/883B SG2803L/DESC SG2821L/DESC SG2823L/DESC SG2824L/DESC SG28XXL	-55°C to 125°C -55°C to 125°C -55°C to 125°C -55°C to 125°C -55°C to 125°C -55°C to 125°C	

- Note 1. Contact factory for JAN and DESC product availability.  
 2. All parts are viewed from the top.  
 3. See Selection Guide for specific device types.