



Kingbor Technology Co.,Ltd
 TEL:(86)0755-26508846 FAX:(86)0755-26509052

KB3361

1.4MHz 800mA High Efficiency Synchronous Step-Down Regulator in SOT23-5

FEATURES

- High Efficiency: Up to 97%
- 75 μ A No Load Quiescent Current
- 800mA Output Current
- 2.5V to 6.5V Input Voltage Range
- 1.4MHz Switching Frequency
- No Schottky Diode Required
- Low Dropout Operation: 100% Duty Cycle
- 0.6V Reference Allows Low Output Voltages
- Shutdown Mode Draws $\leq 1\mu$ A Supply Current
- Current Mode Operation for Excellent Line and Load Transient Response
- Overtemperature Protected
- Low Profile (1.3mm) SOT23-5 Package

APPLICATIONS

- Cellular Telephones
- Personal Information Appliances
- Wireless and DSL Modems
- Digital Still Cameras
- MP3 Players
- Portable Instruments

DESCRIPTION

The KB3361 SwitchReg is a member of Kingbor(KB) product family. It is a 1.4MHz step-down converter with an input voltage range of 2.5V to 6.5V and output as low as 0.6V. Its low supply current, small size, and high switching frequency make the KB3361 the ideal choice for portable applications.

The KB3361 is available in either a programmable version with external feedback resistors. It can deliver up to 800mA of load current while maintaining a low 75 μ A no load quiescent current. The 1.4MHz switching frequency minimizes the size of external components while keeping switching losses low. The KB3361 feedback and control delivers excellent load regulation and transient response with a small output inductor and capacitor.

The KB3361 is designed to maintain high efficiency throughout the operating range and provides fast turn-on time.

The KB3361 is available in a low profile (1.3mm) SOT23-5 package and is rated over the -40 $^{\circ}$ C to +85 $^{\circ}$ C temperature range.

TYPICAL APPLICATION

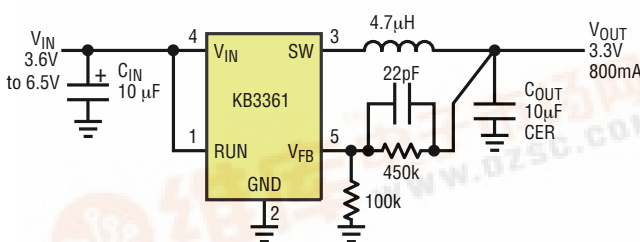

Figure 1a. High Efficiency Step-Down Converter

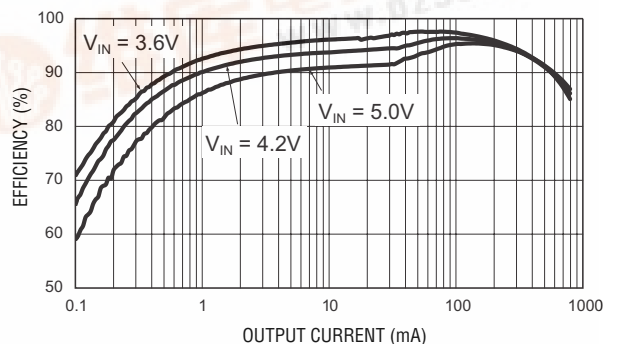

Figure 1b. Efficiency vs Load Current





ABSOLUTE MAXIMUM RATINGS

Input Supply Voltage	-0.3V to 6.5V	Minimum ESD Rating (Human Body Mode)	±2KV
RUN, V _{FB} Voltages	-0.3V to V _{IN}	Operating Temperature Range	-40°C to 85°C
SW Voltage	-0.3V to (V _{IN} + 0.3V)	Junction Temperature	125 °C
P-Channel Switch Source Current (DC)	1A	Storage Temperature Range	-65°C to 150°C
N-Channel Switch Sink Current (DC)	1A	Lead Temperature (Soldering, 10 sec).....	300°C

PACKAGE/ORDER INFORMATION

<p>TOP VIEW</p> <p>MARKING</p> <p>S5 PACKAGE</p> <p>T_{JMAX} = 125°C, θ_{JA} = 250°C/W, θ_{JC} = 90°C/W</p> <p>SOT23-5</p>	ORDER PART NUMBER
	KB3361
	TOP MARKING
	361 XXXX Date Code with one bottom line

ELECTRICAL CHARACTERISTICS

T_A = -40°C to +85°C, unless otherwise noted. Typical values are T_A = 25°C, V_{IN} = 3.6V.

Symbol	Description	Conditions	Min	Typ	Max	Units
Step-Down Converter						
V _{IN}	Input Voltage		2.5		6.5	V
V _{UVLO}	UVLO Threshold	V _{IN} Rising			2.5	V
		Hysteresis		100		mV
		V _{IN} Falling	1.8			V
V _{OUT}	Output Voltage Tolerance	I _{OUT} = 0 to 800mA, V _{IN} = 2.7V to 6.5V	-3.5		+3.5	%
V _{OUT}	Output Voltage Range		0.6		V _{IN}	V
I _Q	Quiescent Current	No Load, 0.6V Adjustable Version		75	90	µA
I _{SHDN}	Shutdown Current	EN = 0V			1.0	µA
I _{LIM}	P-Channel Current Limit			800		mA
R _{DS(ON)H}	High Side Switch On Resistance			0.45		Ω
R _{DS(ON)L}	Low Side Switch On Resistance			0.40		Ω
ΔV _{Linereg}	Line Regulation	V _{IN} = 2.7V to 6.5V		0.1		%/V
V _{OUT}	Out Threshold Voltage Accuracy	0.6V Output, No Load T _A = 25°C	588	600	612	mV
I _{OUT}	Out Leakage Current	0.6V Output			0.2	µA
R _{OUT}	Out Impedance	>0.6V Output	250			kΩ
T _S	Start-Up Time	From Enable to Output Regulation		150		µs
F _{OSC}	Oscillator Frequency	T _A = 25°C	1.0	1.4	2.0	MHz
T _{SD}	Over-Temperature Shutdown Threshold			140		°C
T _{HYS}	Over-Temperature Shutdown Hysteresis			15		°C
EN						
V _{EN(L)}	Enable Threshold Low				0.6	V
V _{EN(H)}	Enable Threshold High		1.4			V
I _{EN}	Input Low Current	V _{IN} = V _{OUT} = 5.5V	-1.0		1.0	µA



TYPICAL PERFORMANCE CHARACTERISTICS

(From Figure1a Except for the Resistive Divider Resistor Values)

Efficiency vs. Load
($V_{OUT} = 1.8V$; $L = 4.7\mu H$)

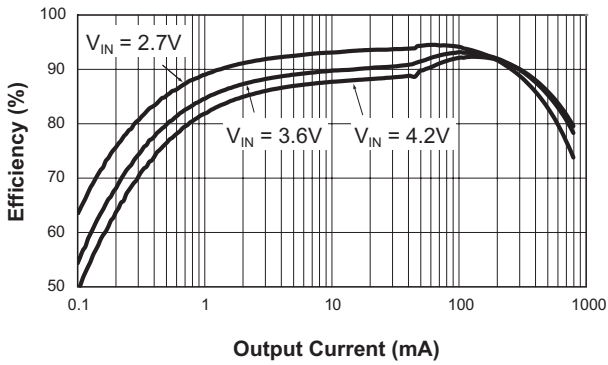

DC Regulation
($V_{OUT} = 1.8V$)

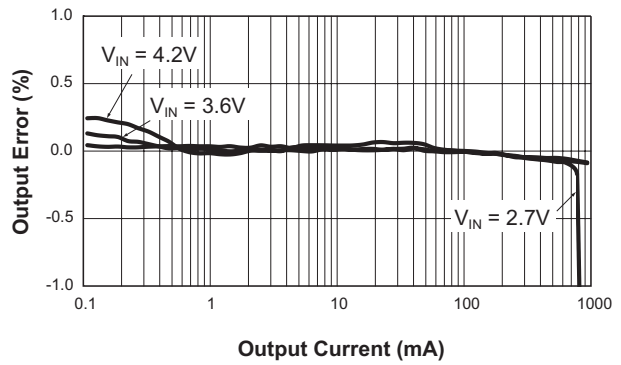

Efficiency vs. Load
($V_{OUT} = 2.5V$; $L = 4.7\mu H$)

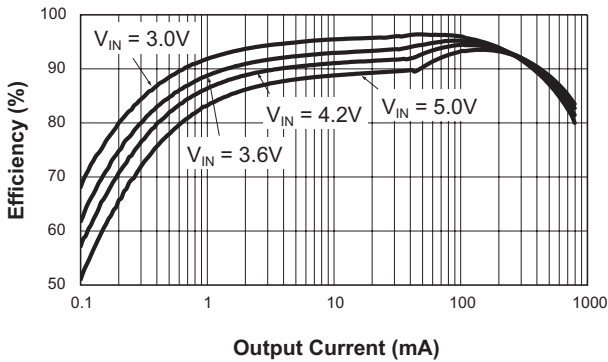

DC Regulation
($V_{OUT} = 2.5V$)

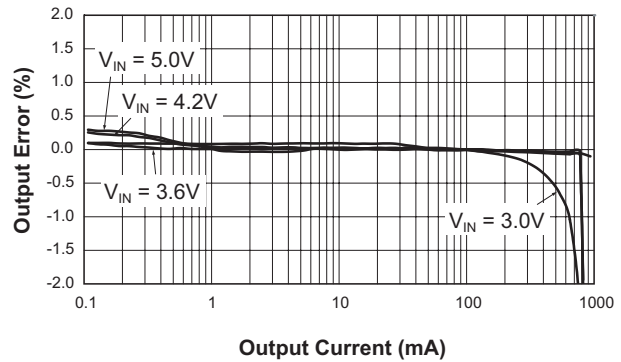

Efficiency vs. Load
($V_{OUT} = 3.3V$; $L = 4.7\mu H$)

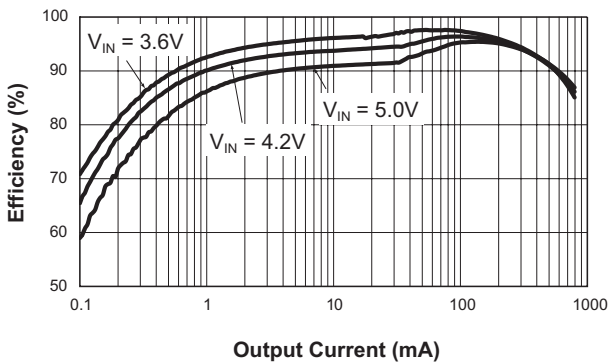

DC Regulation
($V_{OUT} = 3.3V$; $L = 4.7\mu H$)

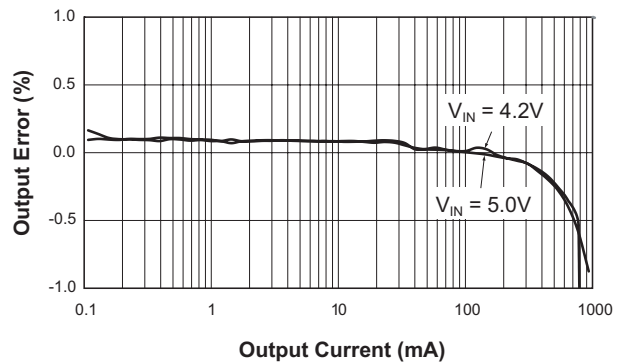



TYPICAL PERFORMANCE CHARACTERISTICS

(From Figure 1a Except for the Resistive Divider Resistor Values)

Line Response
 ($V_{OUT} = 1.8V @ 800mA$)

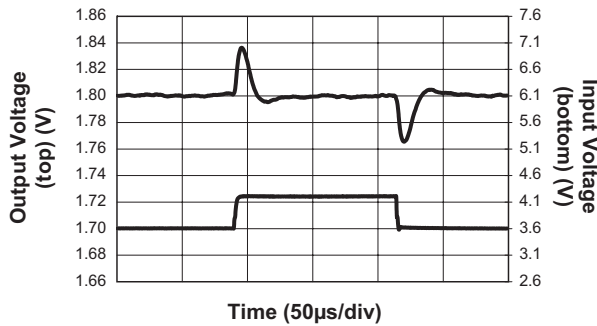

Output Ripple
 ($V_{IN} = 3.6V; V_{OUT} = 1.8V; I_{OUT} = 800mA$)

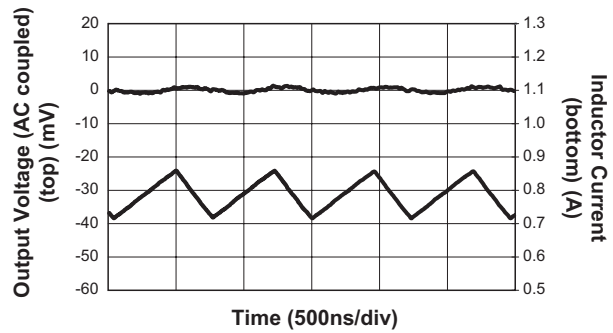

Output Ripple
 ($V_{IN} = 3.6V; V_{OUT} = 1.8V; I_{OUT} = 1mA$)

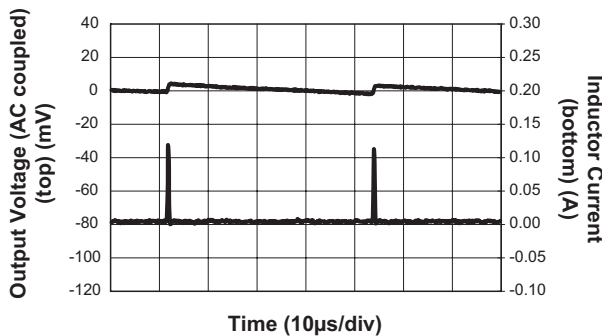

P-Channel $R_{DS(ON)}$ vs. Input Voltage

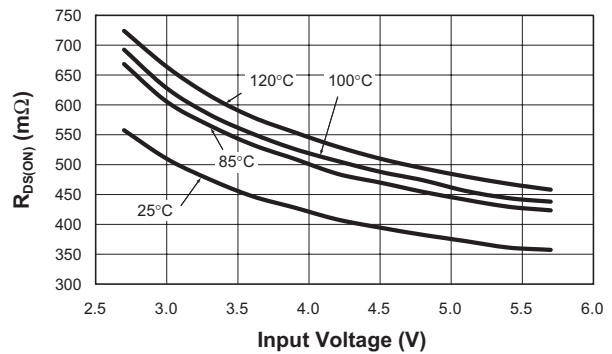

N-Channel $R_{DS(ON)}$ vs. Input Voltage

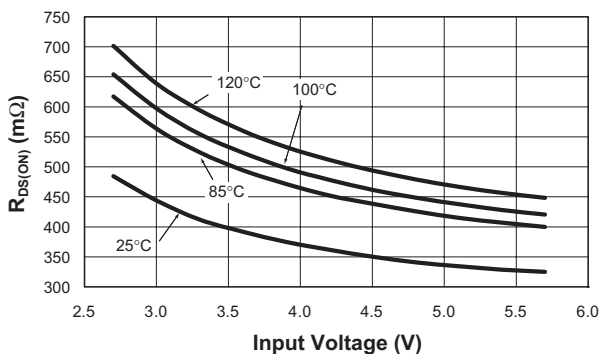

No Load Quiescent Current vs. Input Voltage

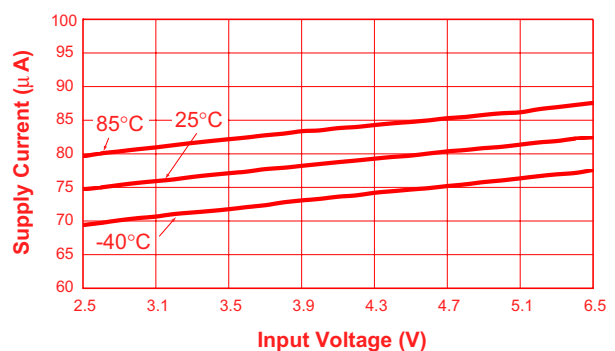

PIN FUNCTIONS

RUN (Pin 1): Run Control Input. Forcing this pin above 1.5V enables the part. Forcing this pin below 0.6V shuts down the device. In shutdown, all functions are disabled drawing $<1\mu A$ supply current. Do not leave RUN floating.

GND (Pin 2): Ground Pin.

SW (Pin 3): Switch Node Connection to Inductor. This pin connects to the drains of the internal main and synchronous power MOSFET switches.

V_{IN} (Pin 4): Main Supply Pin. Must be closely decoupled to GND, Pin 2, with a $4.7\mu F$ or greater Tan capacitor.

V_{FB} (Pin 5) (KB3361): Feedback Pin. Receives the feedback voltage from an external resistive divider across the output.



SIMPLIFIED BLOC DIAGRAM

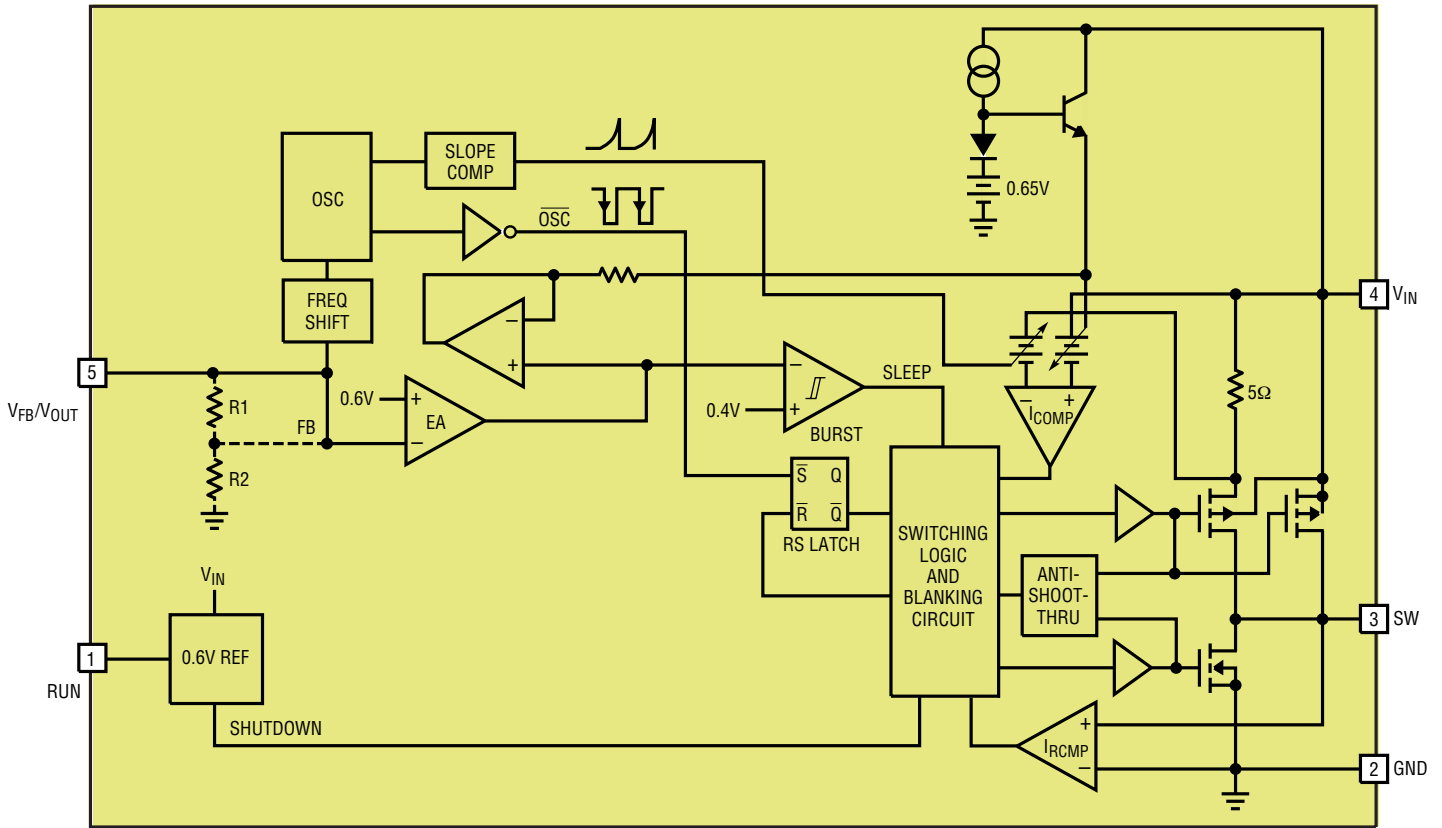

TYPICAL APPLICATION

Tiny 3.3V/800mA Buck Regulator

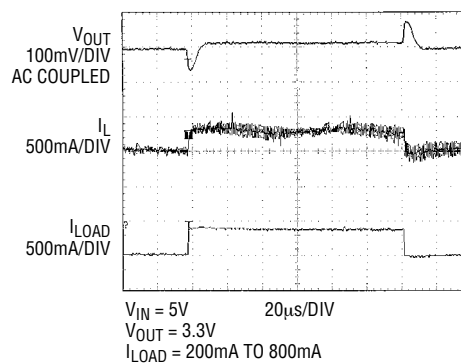
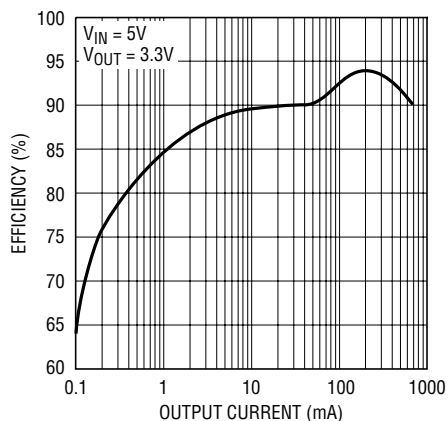
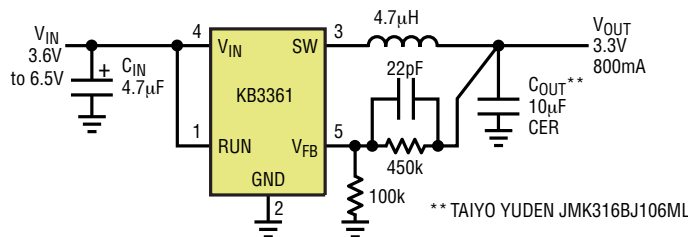



PACAGE DESCRIPTION

S5 Package 5-Lead Plastic TSOT-23(SOT23-5)

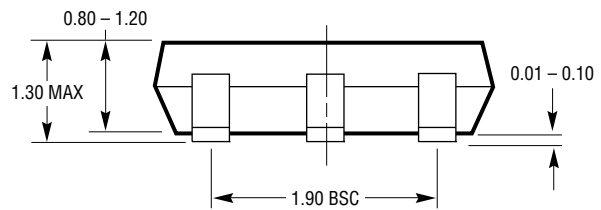
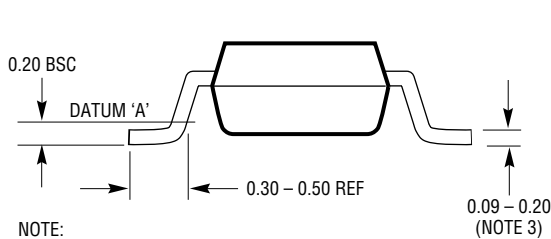
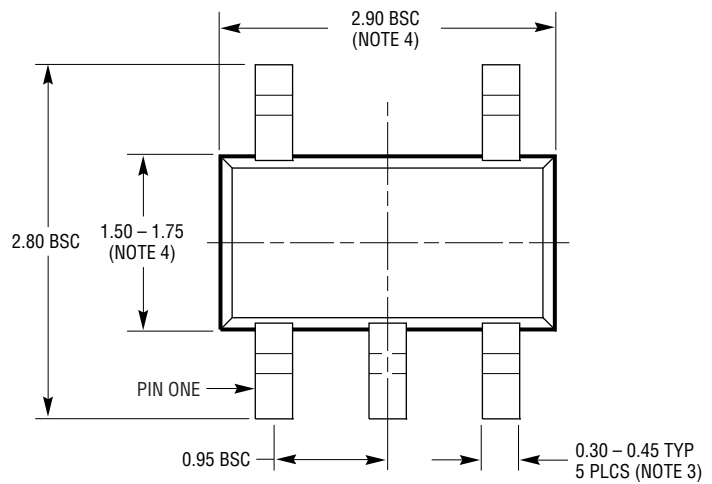
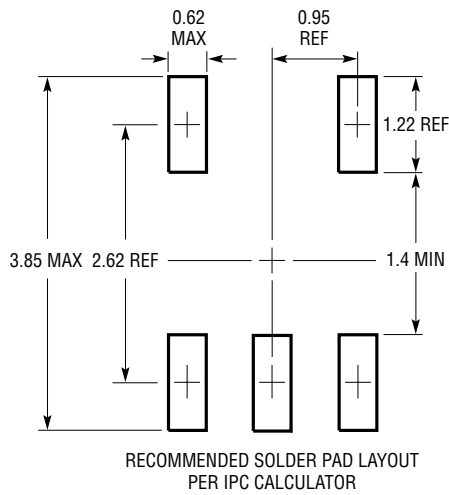

- NOTE:
1. DIMENSIONS ARE IN MILLIMETERS
 2. DRAWING NOT TO SCALE
 3. DIMENSIONS ARE INCLUSIVE OF PLATING
 4. DIMENSIONS ARE EXCLUSIVE OF MOLD FLASH AND METAL BURR
 5. MOLD FLASH SHALL NOT EXCEED 0.254mm
 6. JEDEC PACKAGE REFERENCE IS MO-193