

Kingbright

PHOTOCOUPLER

KB852Series

Features

- 1.High collector-emitter voltage.
(Vceo:350V)
- 2.High isolation voltage between input and output.
(Viso:5000Vrms)
- 3.Compact dual-in-line package.
- 4.High current transfer ratio.
(CTR:MIN.1000% at IF=1mA, Vce=2V)
- 5.Rohs compliant.

Applications

- 1.Telephone sets.
- 2.Interface with various power supply circuits, power distribution boards.
- 3.Copiers,facsimiles.
- 4.Numerical control machines.

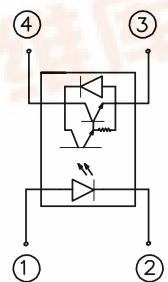
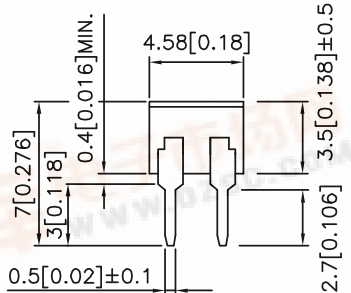
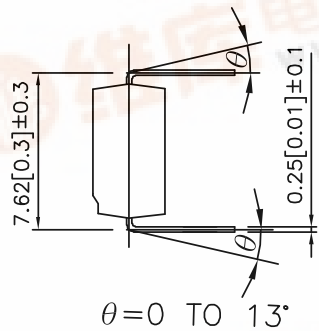
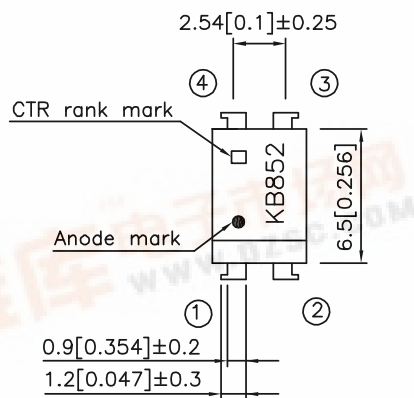

① Anode ② Cathode ③ Emitter ④ Collector

UNIT : MM[INCH]
TOLERANCE : ±0.5[±0.02] UNLESS OTHERWISE NOTED.



KB852Series

*Absolute Maximum Ratings (Ta=25°C)

Parameter		Symbol	Rating	Unit
Input	Forward current	IF	50	mA
	Reverse voltage	VR	6	V
	Power dissipation	P	70	mW
Output	Collector-emitter voltage	VCEO	350	V
	Emitter-collector voltage	VECO	0.1	V
	Collector current	IC	150	mA
	Collector power dissipation	Pc	150	mW
Total power dissipation		P tot	200	mW
*1 Isolation voltage		V iso	5000	Vrms
Operating temperature		T opr	-30 to +100	°C
Storage temperature		T stg	-55 to +125	°C
*2 Soldering temperature		T sol	260	°C

*1 40 to 60%RH, AC for 1 minute.

*2 For 10 seconds.

*Electro-optical Characteristics

Parameter		Symbol	Conditions	Min.	Typ.	Max.	Unit
Input	Forward voltage	VF	IF=10mA	-	1.2	1.4	V
	Peak forward voltage	VFM	IFM=0.5A	-	-	3.0	V
	Reverse current	IR	VR=4V	-	-	10	uA
Output	Collector dark current	ICEO	Vce=200V IF=0	-	-	10 ⁻⁷	A
Transfer characteristics	Current transfer ration	CTR	IF=1mA Vce=2V	1000	4000	15000	%
	Collector-emitter saturation voltage	VCE (sat)	IF=20mA IC=100mA	-	-	1.2	V
	Response time	Rise time	tr	Vce=2V IC=20mA RL=1000Ω	-	100	300
Fall time		tr	-		20	100	uS

Fig. 1 Forward Current vs. Ambient Temperature

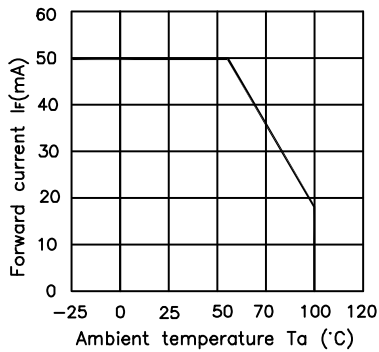

Fig. 2 Collector Power Dissipation VS Ambient Temperature

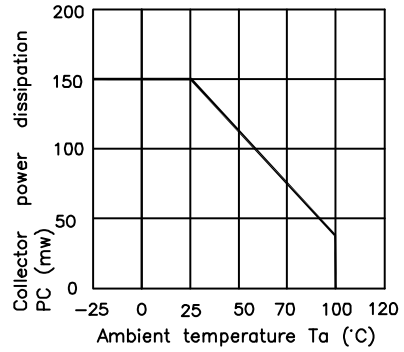

Fig. 3 Current Transfer Ratio vs. Forward Current

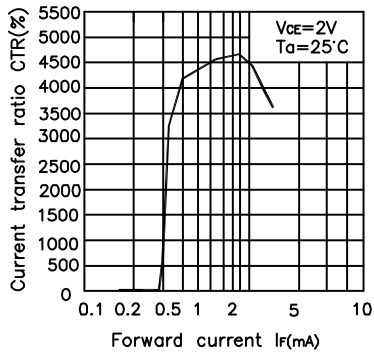

Fig. 4 Forward Current vs. Forward voltage

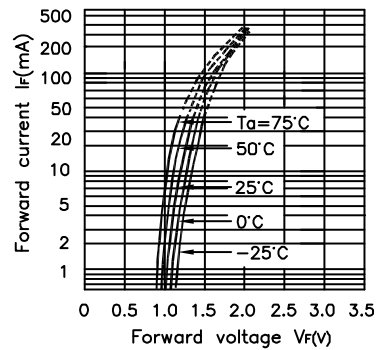

Fig. 5 Collector Current vs. Collector-emitter Voltage

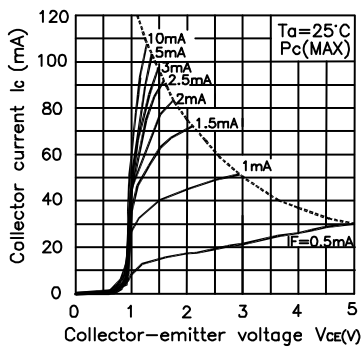
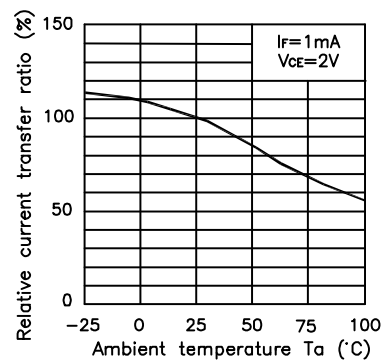
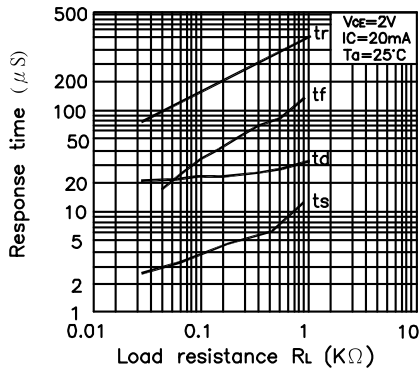

Fig. 6 Relative Current Transfer Ratio vs. Ambient Temperature



KB852Series

Fig. 7 Response Time vs. Load Resistance



Test Circuit for Response Time

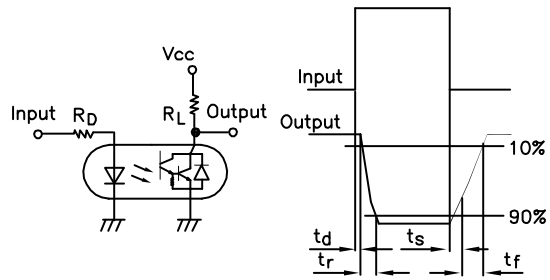

Fig. 8 Collector-emitter Saturation Voltage vs. Ambient Temperature

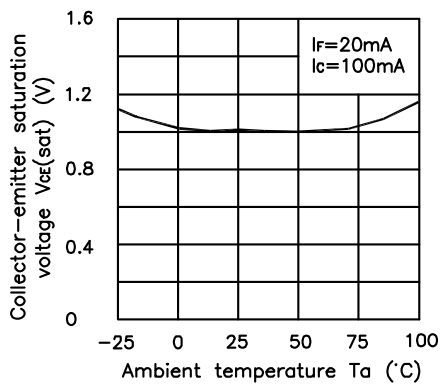
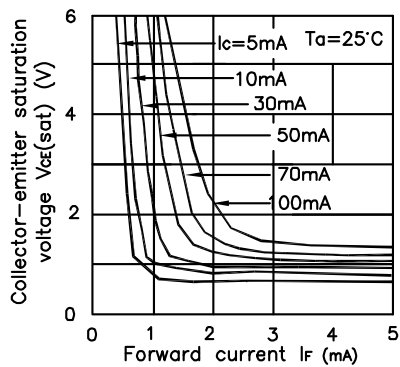

Fig. 9 Collector-emitter Saturation Voltage vs. Forward Current



*** NOTES ON HANDLING**

1.Recommended soldering conditions (Dip soldering)

(1) Dip soldering

Temperature	260°C or below (molten solder temperature)
Time	Less than 10 seconds.
Cycle	One cycle allowed to be dipped in solder including plastic mold portion.
Flux	Rosin flux containing small amount of chlorine (The flux with a maximum chlorine content of 0.2 Wt % is recommended.)

(2) Cautions

Fluxes

Avoid removing the residual flux with freon-based and chlorine-based cleaning solvent.

2.Cautions regarding noise

Be aware that power is suddenly into the component any surge current may cause damage happen, even if the voltage is within the absolute maximum ratings.

CAUTION

Within this device there exists GaAs (Gallium Arsenide) material which is a harmful substance if ingested.

GaAs dust and fumes are toxic. Do not break, cut or pulverize the product, or use chemicals to dissolve them.

RESTRICTIONS ON PRODUCT USE

- The information in this document is subject to change without notice. Before using this document, please confirm that this is the latest version. Not all devices / types available in every country.
- We mention about our product quality stability, semiconductor devices in general can malfunction or fail due to their inherent electrical sensitivity and vulnerability to physical stress. It is the responsibility of the buyer, when utilizing KINGBRIGHT products, to observe standards of safety, and to avoid situations in which a malfunction or failure of a KINGBRIGHT product could cause loss of human life, bodily injury or damage to property. In developing your designs, please ensure that KINGBRIGHT products are used within specified operating ranges as set forth in the most recent products specifications.

KB852Series

KB852

Dimension of Tube

TOLERANCE : $\pm 0.4[\pm 0.012]$ UNLESS OTHERWISE NOTED.

Unit:mm

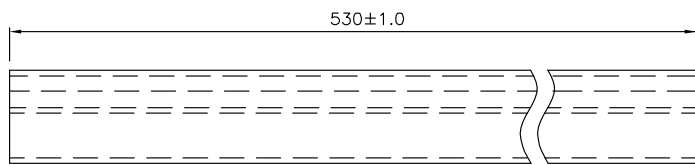
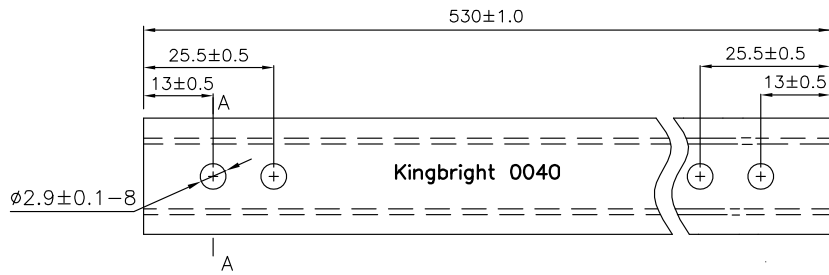

A-A Side view

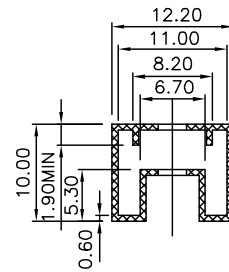

Dimension of Carton

