



T R I Q U I N T S E M I C O N D U C T O R , I N C .

TGL8784-SCC

Analog Attenuator

8784

- 2 to 20-GHz Frequency Range
- 2-dB Insertion Loss at Midband
- 10-dB Input/Output Return Loss
- 13-dB Variable Attenuation Range
- Single Polarity Power Supply Required
- 1,702 x 1,219 x 0,152 mm (0.067 x 0.048 x 0.006 in.)

PHOTO ENLARGEMENT

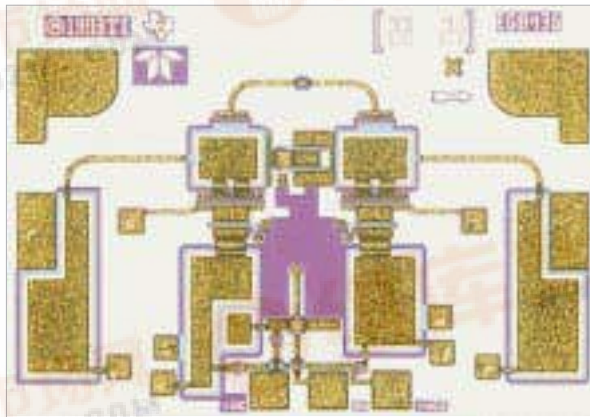

DESCRIPTION

The TriQuint TGL8784-SCC is a monolithic variable attenuator which operates from 2 to 20-GHz. This analog attenuator can operate from a single +2.5 v olt power supply if used with an external variable voltage divider circuit. Typical RF performance at 10-GHz is: Insertion Loss 2-dB, Maximum attenuation: 15-dB at 10-GHz, input and output return loss: better than 10-dB. DC blocking capacitors are provided on-chip.

The TGL8784-SCC is an absorptive attenuator designed using MESFET technology employing a "PI" configuration which reduces bias currents and simplifies bias networks. The broadband capabilities of this device are versatile in many applications such as telecommunications, military, and space. This device has a space heritage.

Bond pad and backside metallization is gold plated for compa tibility with eutectic alloy attachment methods as well as thermocompression and thermosonic wire-bonding processes. The TGL8784-SCC is supplied in chip form and is readily assembled using automated equipment. Groun d is provided to the circuitry through vias to the backside metallization.



TYPICAL ATTENUATION VS CONTROL VOLTAGE +V_C

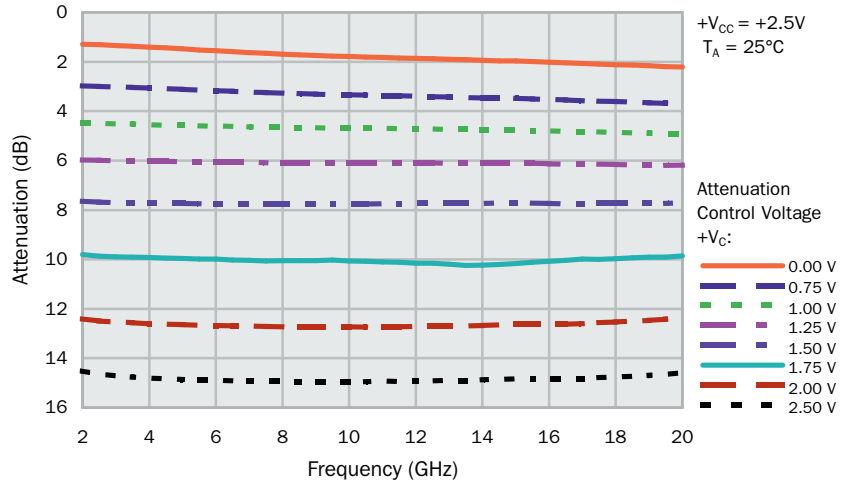

TYPICAL INSERTION LOSS VS TEMPERATURE

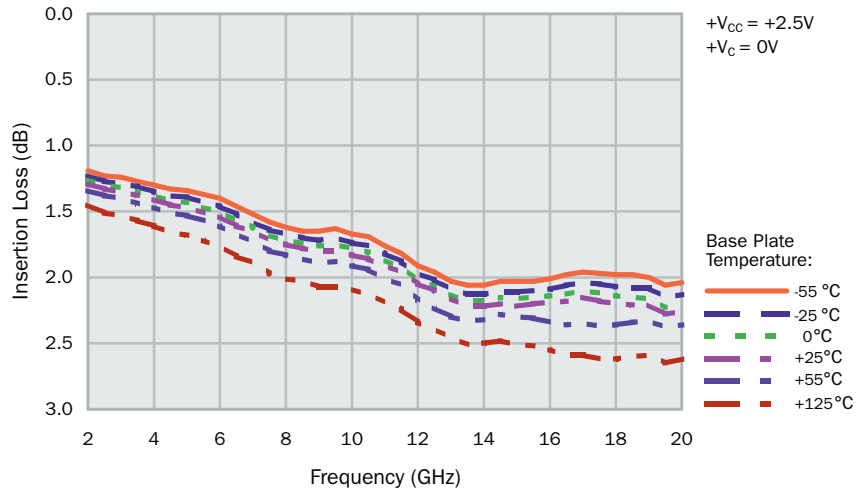

TYPICAL INPUT POWER AT 1 dB ATTENUATION CHANGE VS +V_C P1dB

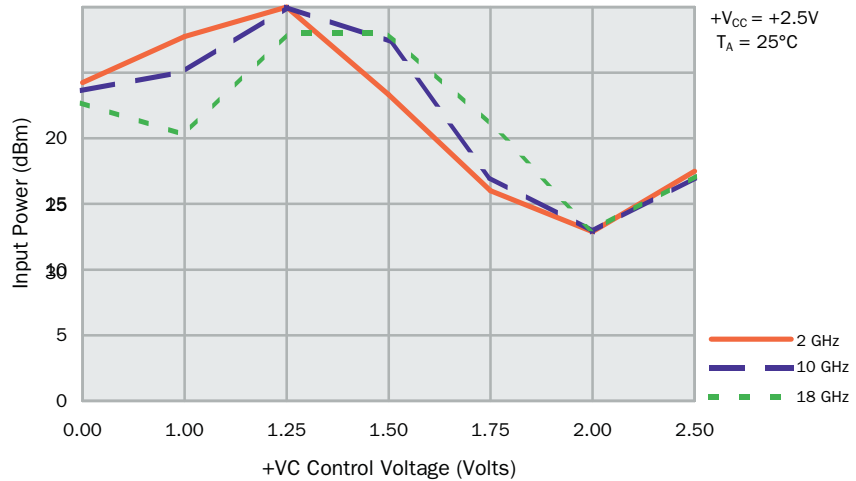

Recommended Maximum P_{IN} is 24dBm.
P1dB data taken at control voltages (+V_C) listed at major division points on graph only.

**TYPICAL
INPUT POWER AT
1 dB ATTENUATION CHANGE
VS TEMPERATURE**

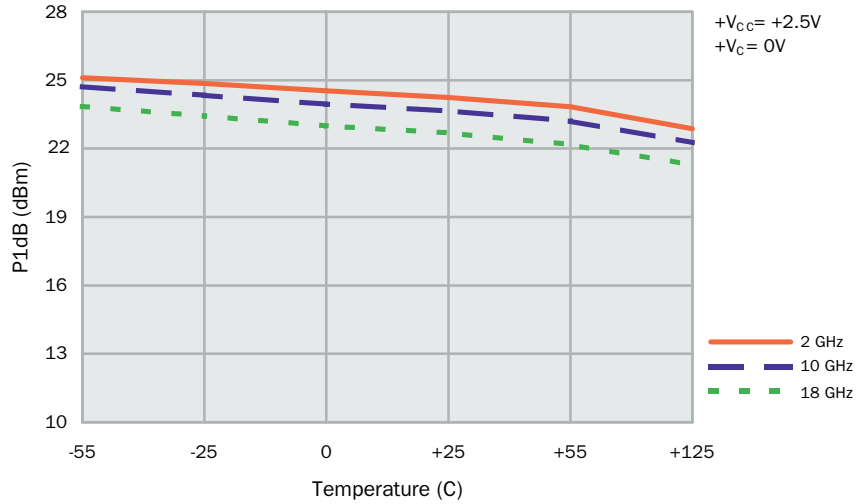

**TYPICAL
INPUT RETURN LOSS**

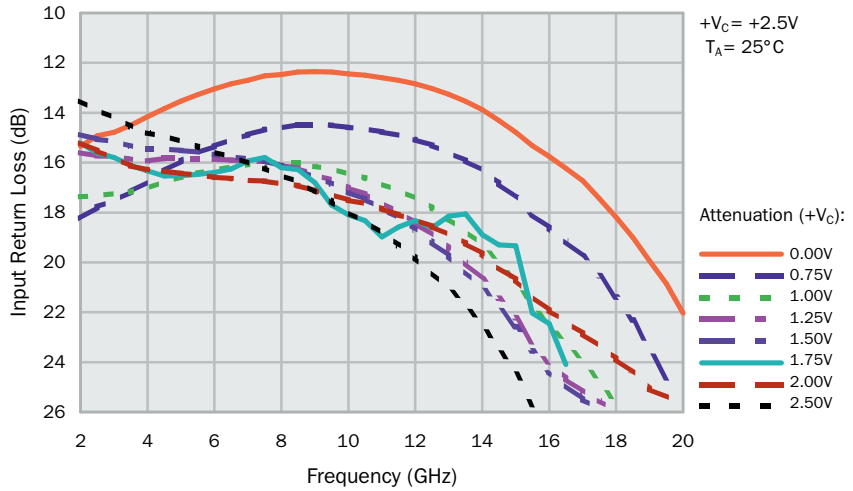

**TYPICAL
OUTPUT RETURN LOSS**

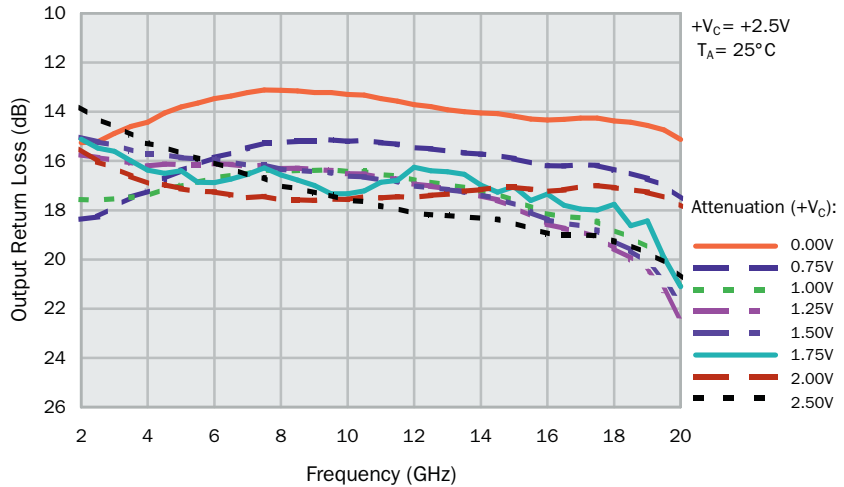

**TYPICAL INSERTION
PHASE VS +V_C**

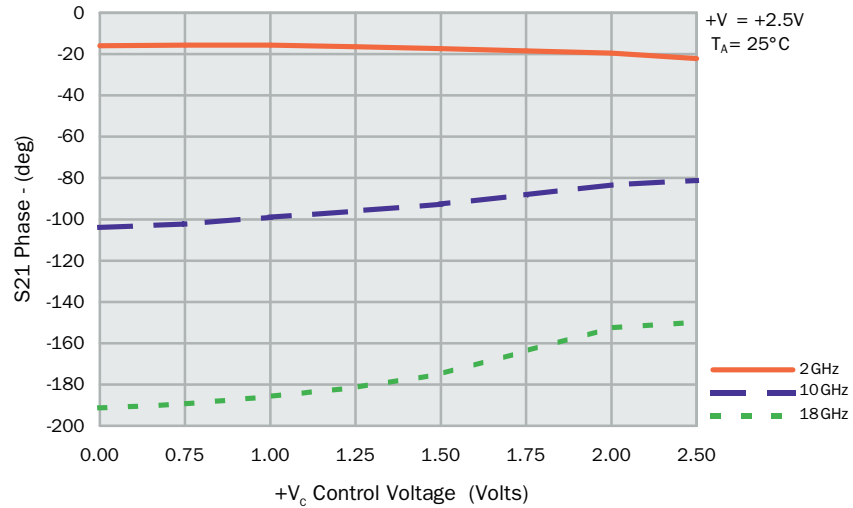

**ABSOLUTE
MAXIMUM RATINGS**

Positive Supply voltage, +V _{CC}	10 V
Attenuation control voltage, +V _C , (+V _{CC} > +V _C)	0 V to +10 V
Input continuous wave power, P _{IN}	24 dBm
Operating channel temperature, T _{CH} *	150 °C
Mounting temperature (30 sec), T _M	320 °C
Storage temperature range, T _{STG}	-65 to 150 °C

Ratings over operating channel temperature range, T_{CH} (unless otherwise noted)

Stresses beyond those listed under “Absolute Maximum Ratings” may cause permanent damage to the device. These are stress ratings only, and functional operation of the device at these or any other conditions beyond those indicated under “RF Characteristics” is not implied. Exposure to absolute maximum rated conditions for extended periods may affect device reliability.

* Operating channel temperature directly affects the device MTTF. For maximum life, it is recommended that channel temperature be maintained at the lowest possible level.

TYPICAL S-PARAMETERS
Insertion Loss

Frequency (GHz)	S11		S21		S12		S22	
	dB	ANG(°)	dB	ANG(°)	dB	ANG(°)	dB	ANG(°)
2.0	-15.34	-70.1	-1.29	-18.0	-1.29	-17.9	-15.26	-70.5
2.5	-14.92	-75.4	-1.31	-23.1	-1.31	-23.1	-15.22	-77.4
3.0	-14.78	-81.8	-1.34	-28.1	-1.35	-28.1	-14.88	-83.1
3.5	-14.50	-87.0	-1.37	-32.8	-1.37	-32.8	-14.59	-88.8
4.0	-14.16	-92.0	-1.41	-37.5	-1.41	-37.5	-14.43	-94.7
4.5	-13.84	82.1	-1.44	-42.1	-1.45	-42.1	-14.05	79.3
5.0	-13.53	77.2	-1.48	-46.7	-1.48	-46.6	-13.80	73.9
5.5	-13.28	72.6	-1.52	-51.2	-1.52	-51.1	-13.65	68.3
6.0	-13.05	68.1	-1.55	-55.6	-1.55	-55.6	-13.47	62.8
6.5	-12.84	63.8	-1.59	-60.1	-1.59	-60.1	-13.36	57.6
7.0	-12.70	59.5	-1.63	-64.5	-1.63	-64.5	-13.22	53.1
7.5	-12.52	55.4	-1.66	-68.9	-1.66	-68.8	-13.11	47.7
8.0	-12.47	51.8	-1.69	-73.2	-1.69	-73.2	-13.13	43.4
8.5	-12.37	48.2	-1.72	-77.6	-1.72	-77.6	-13.15	38.3
9.0	-12.35	45.1	-1.74	-82.0	-1.74	-82.0	-13.22	33.6
9.5	-12.37	41.2	-1.77	-86.4	-1.77	-86.4	-13.22	29.2
10.0	-12.44	37.9	-1.79	-90.8	-1.79	-90.8	-13.30	25.2
10.5	-12.49	34.2	-1.81	-95.2	-1.82	-95.2	-13.32	20.9
11.0	-12.60	31.1	-1.83	-99.7	-1.83	-99.6	-13.46	16.8
11.5	-12.70	27.8	-1.85	-104.1	-1.85	-104.1	-13.57	12.5
12.0	-12.84	24.6	-1.86	-108.6	-1.86	-108.6	-13.71	8.7
12.5	-13.03	21.2	-1.88	-113.0	-1.88	-113.1	-13.79	4.9
13.0	-13.26	17.7	-1.90	-117.6	-1.90	-117.6	-13.92	1.0
13.5	-13.54	14.1	-1.92	-122.1	-1.93	-122.1	-14.00	-2.3
14.0	-13.87	-169.7	-1.94	-126.6	-1.94	-126.6	-14.05	174.4
14.5	-14.31	-173.8	-1.96	-131.1	-1.96	-131.2	-14.08	171.5
15.0	-14.78	-177.7	-1.97	-135.8	-1.97	-135.8	-14.18	169.0
15.5	-15.32	178.8	-1.99	-140.4	-1.99	-140.4	-14.29	166.4
16.0	-15.75	174.6	-2.02	-145.1	-2.02	-145.1	-14.33	163.5
16.5	-16.23	169.7	-2.05	-149.7	-2.05	-149.7	-14.31	160.2
17.0	-16.73	164.4	-2.07	-154.4	-2.07	-154.4	-14.25	156.6
17.5	-17.44	158.9	-2.09	-159.1	-2.10	-159.1	-14.26	153.2
18.0	-18.18	154.2	-2.12	-163.9	-2.12	-163.9	-14.37	149.9
18.5	-19.00	149.2	-2.14	-168.7	-2.14	-168.7	-14.42	146.8
19.0	-19.94	144.8	-2.16	-173.6	-2.17	-173.6	-14.55	143.8
19.5	-20.86	141.8	-2.20	-178.4	-2.20	-178.4	-14.73	140.8
20.0	-22.03	138.4	-2.21	176.7	-2.22	176.7	-15.13	138.4
20.5	-23.40	136.5	-2.24	171.7	-2.24	171.7	-15.52	136.0
21.0	-25.21	135.6	-2.27	166.6	-2.25	166.6	-15.87	133.3
21.5	-27.33	136.2	-2.29	161.4	-2.30	161.4	-16.28	131.1
22.0	-29.25	143.4	-2.33	156.2	-2.33	156.2	-16.73	128.7

T_A = 25°C, +V_{cc} = +2.5 V, +V_c = 0 V

Reference planes for S-parameter data include bond wires as specified in the "Recommended Assembly Diagram."

TYPICAL S-PARAMETERS
Maximum Attenuation

Frequency (GHz)	S11		S21		S12		S22	
	dB	ANG(°)	dB	ANG(°)	dB	ANG(°)	dB	ANG(°)
2.0	-13.53	-140.0	-14.51	-24.0	-14.51	-24.0	-13.82	-143.7
2.5	-13.90	-146.6	-14.64	-26.0	-14.64	-26.0	-14.30	-152.4
3.0	-14.20	-153.5	-14.72	-28.4	-14.72	-28.4	-14.59	-158.5
3.5	-14.55	-157.9	-14.76	-31.0	-14.77	-31.0	-14.94	-163.2
4.0	-14.81	-161.5	-14.81	-33.8	-14.81	-33.7	-15.28	-167.9
4.5	-14.94	14.8	-14.84	-36.6	-14.84	-36.6	-15.42	8.5
5.0	-15.16	12.4	-14.86	-39.6	-14.86	-39.6	-15.70	5.5
5.5	-15.36	9.8	-14.89	-42.7	-14.88	-42.7	-15.91	2.0
6.0	-15.57	7.3	-14.89	-45.8	-14.90	-45.8	-16.07	-1.0
6.5	-15.77	5.5	-14.91	-48.9	-14.92	-49.0	-16.30	-3.9
7.0	-16.02	3.7	-14.93	-52.2	-14.93	-52.2	-16.58	-5.8
7.5	-16.23	2.1	-14.94	-55.5	-14.94	-55.4	-16.68	-8.3
8.0	-16.51	0.7	-14.94	-58.7	-14.94	-58.7	-17.01	-10.4
8.5	-16.77	-0.8	-14.95	-62.1	-14.95	-62.1	-17.13	-13.3
9.0	-17.20	-2.0	-14.95	-65.4	-14.95	-65.4	-17.29	-16.0
9.5	-17.55	-3.7	-14.95	-68.9	-14.96	-68.9	-17.40	-17.7
10.0	-18.00	-5.3	-14.95	-72.2	-14.95	-72.3	-17.60	-20.1
10.5	-18.37	-7.1	-14.95	-75.7	-14.94	-75.7	-17.66	-22.1
11.0	-18.82	-8.4	-14.93	-79.3	-14.94	-79.2	-17.84	-24.7
11.5	-19.32	-9.5	-14.94	-82.7	-14.93	-82.7	-17.93	-27.1
12.0	-19.81	-10.7	-14.92	-86.3	-14.92	-86.3	-18.12	-29.5
12.5	-20.40	-12.2	-14.91	-89.9	-14.91	-89.9	-18.19	-31.9
13.0	-21.04	-13.5	-14.90	-93.4	-14.91	-93.4	-18.22	-34.3
13.5	-21.75	-15.4	-14.90	-97.0	-14.90	-97.1	-18.26	-36.7
14.0	-22.53	162.7	-14.87	-100.6	-14.87	-100.5	-18.33	141.2
14.5	-23.52	160.3	-14.85	-104.2	-14.86	-104.3	-18.37	139.6
15.0	-24.44	157.4	-14.84	-107.9	-14.83	-107.9	-18.52	137.6
15.5	-25.71	155.1	-14.82	-111.7	-14.82	-111.7	-18.75	135.3
16.0	-26.92	151.0	-14.84	-115.4	-14.83	-115.5	-18.96	132.9
16.5	-27.98	148.4	-14.84	-118.9	-14.85	-118.9	-19.02	131.0
17.0	-29.13	144.4	-14.82	-122.4	-14.82	-122.5	-19.00	128.9
17.5	-30.24	140.6	-14.78	-126.0	-14.79	-126.0	-19.03	127.1
18.0	-31.56	135.1	-14.75	-129.8	-14.75	-129.8	-19.27	124.7
18.5	-32.76	129.4	-14.73	-133.5	-14.72	-133.5	-19.44	123.0
19.0	-34.78	124.1	-14.69	-137.3	-14.68	-137.3	-19.73	121.5
19.5	-36.56	125.8	-14.66	-141.0	-14.65	-141.1	-20.11	120.3
20.0	-38.64	119.2	-14.58	-144.8	-14.59	-144.8	-20.73	119.2
20.5	-45.80	100.5	-14.56	-148.7	-14.57	-148.8	-21.31	117.4
21.0	-53.20	6.6	-14.53	-152.9	-14.50	-152.9	-22.01	114.7
21.5	-43.52	-44.2	-14.47	-157.0	-14.50	-157.0	-22.83	114.2
22.0	-39.20	-62.3	-14.48	-161.1	-14.47	-161.1	-23.56	113.7

T_A = 25°C, +V_{cc} = 2.5 V, +V_c = 2.5 V

Reference planes for S-parameter data include bond wires as specified in the "Recommended Assembly Diagram."

RF CHARACTERISTICS

PARAMETER		TEST CONDITIONS	TYP	UNIT
IL	Insertion Loss	f=2.0 GHz , +V _c =0V	1.5	dB
		f=10.0 GHz , +V _c =0V	2.0	dB
		f=20.0 GHz , +V _c =0V	2.5	dB
	Maximum Attenuation	f=2 to 20 GHz, +V _c =+2.5V	15	dB
IRL	Input Return Loss	2.0 to 20 GHz	10	dB
ORL	Output Return Loss	2.0 to 20 GHz	10	dB
P1dB	Input Power at 1dB Atten. Change	2,10 and 18 GHz	*	dBm

* P1dB varies depending on +V_c setting and frequency. See graph on page 2 for details.

+V_{cc} =2.5 V, +V_c = 0.0 V, T_A = 25°C unless stated

THERMAL INFORMATION

PARAMETER		TEST CONDITIONS	NOM	UNIT
R _{JC}	Thermal resistance, channel to backside	70°C Base,+V _{cc} =+2.5V,+V _c =+2.5V *	300	°C/W

* Thermal Resistance analysis based on Max P_{IN}=24 dBm and +V_c set for maximum attenuation.
Power dissipation in Q1 is 135mW which represents a worst-case condition.

EQUIVALENT SCHEMATIC

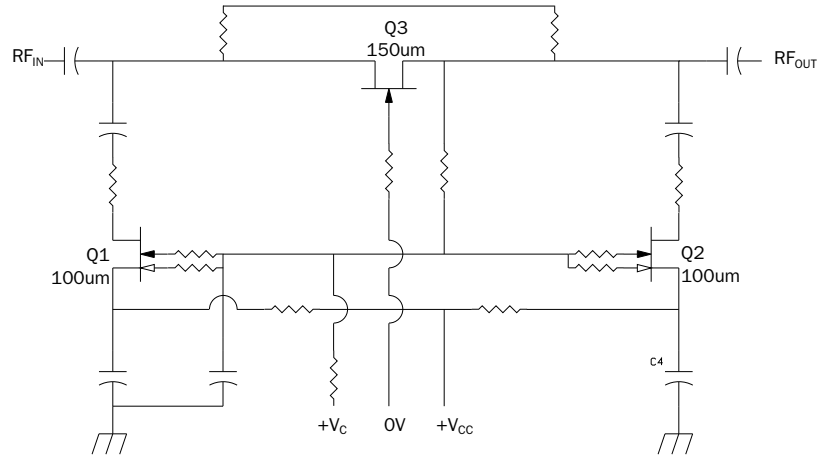

RECOMMENDED ASSEMBLY DIAGRAM

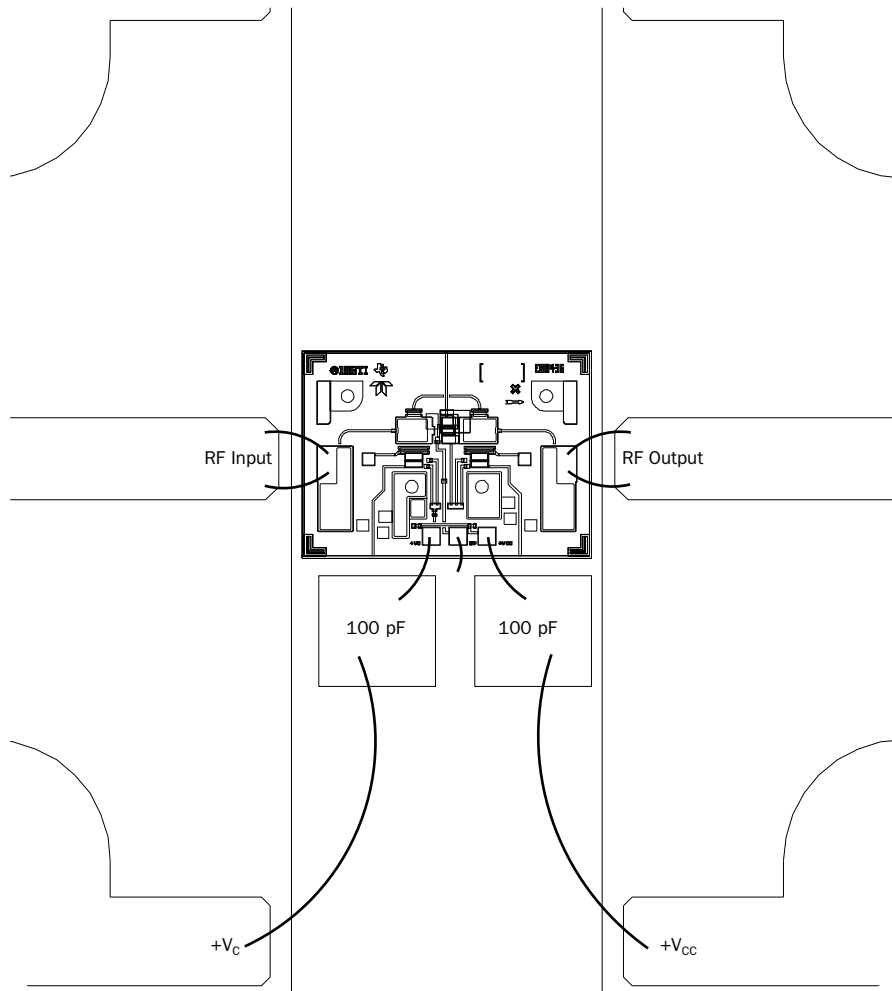

Bond using two 1.0-mil diameter, 25 to 30-mil length gold bondwires at both RF Input and RF Output for optimum performance. Close placement of external components is essential.

MECHANICAL DRAWING

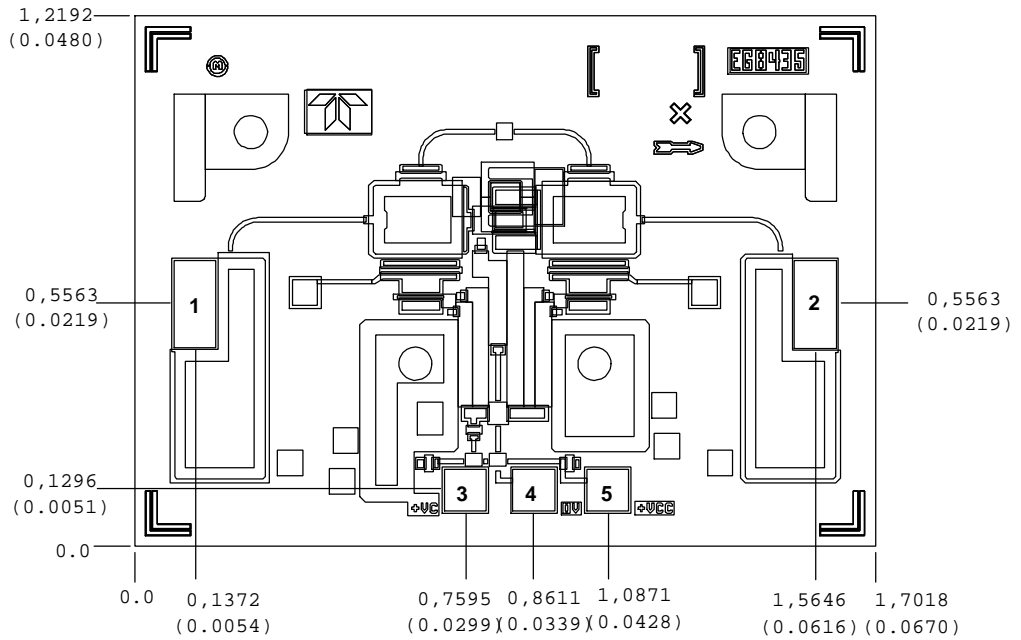

Units: millimeters (inches)

Thickness: 0,1524 (0.006) (reference only)

Chip edge to bond pad dimensions are shown to center of bond pad.

Chip size $\pm 0,0508$ (0.002)

Bond pad #1 (RF Input):	0,0960 x 0,2000 (0.0038 x 0.0079)
Bond pad #2 (RF Output):	0,0960 x 0,2000 (0.0038 x 0.0079)
Bond pad #3 (+V _C , Attenuation Control):	0,0960 x 0,0960 (0.0038 x 0.0038)
Bond pad #4 (0V):	0,0960 x 0,0960 (0.0038 x 0.0038)
Bond pad #5 (+V _{CC}):	0,0960 x 0,0960 (0.0038 x 0.0038)