

**NPN Planer RF TRANSISTOR**

**DESCRIPTION**

The THN6201S is a low Noise figure and good associated gain performance at UHF,VHF and Microwave frequencies  
It is suitable for a high density surface mount since transistor has been SOT23 package

**FEATURES**

- o Low Noise Figure  
N.F = 1.1dB TYP. @ f=1GHz, V<sub>CE</sub>=3V, I<sub>c</sub>=5mA  
N.F = 1.5dB TYP. @ f=2GHz, V<sub>CE</sub>=3V, I<sub>c</sub>=5mA
- o High Gain  
MSG = 16.5dB TYP. @ f=1GHz, V<sub>CE</sub>=3V, I<sub>c</sub>=15mA  
MAG = 11.5dB TYP. @ f=2GHz, V<sub>CE</sub>=3V, I<sub>c</sub>=15mA
- o High Transition Frequency  
f<sub>T</sub> = 12GHz TYP. @ f=2GHz, V<sub>CE</sub>=3V, I<sub>c</sub>=15mA

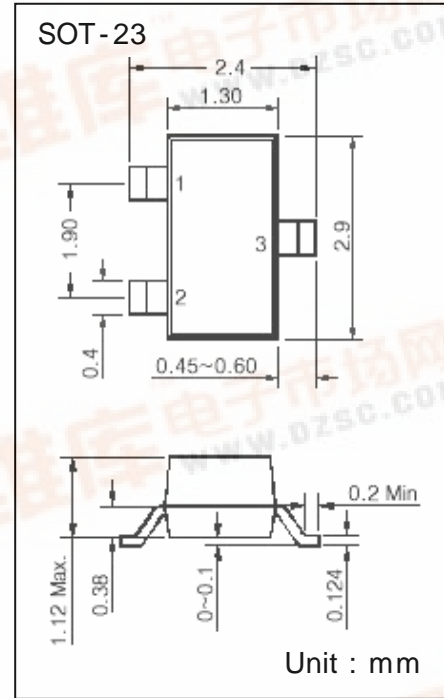

**PIN CONFIGURATION**

PIN NO	SYMBOL	DESCRIPTION
1	B	Base
2	E	Emitter
3	C	Collector

**MARKING : AC1**

**MAXIMUM RATINGS**

SYMBOL	PARAMETER	CONDITION	VALUE	Unit
V <sub>CB0</sub>	Collector-Base Voltage	Open Emitter	25	V
V <sub>CEO</sub>	Collector-Emitter Voltage	Open Base	12	V
V <sub>EBO</sub>	Emitter-Base Voltage	Open Collector	2.5	V
I <sub>c</sub>	Collector Current (DC)		35	mA
P <sub>T</sub>	Total Power Dissipation	T <sub>s</sub> = 60	150	mW
T <sub>STG</sub>	Storage Temperature		-65 ~ 150	
T <sub>J</sub>	Operating Junction Temperature		150	



**Electrical Characteristics (  $T_A = 25$  )**

SYMBOL	PARAMETER	CONDITION	VALUE			Unit
			min	typ	max	
V <sub>CBO</sub>	Collector-Base Voltage	I <sub>CE</sub> = 100uA, I <sub>E</sub> = 0	20	25		V
V <sub>CEO</sub>	Collector-Emitter Voltage	I <sub>CE</sub> = 100uA, I <sub>B</sub> = 0	12	14		V
I <sub>CBO</sub>	Collector-Cut-off current	V <sub>CB</sub> = 10V, I <sub>E</sub> = 0			300	n A
I <sub>EBO</sub>	Emitter-Cut-off current	V <sub>EB</sub> = 1V, I <sub>C</sub> = 0			100	n A
h <sub>fe</sub>	D.C current Gain	V <sub>CE</sub> = 3V, I <sub>C</sub> = 15mA	130		300	
f <sub>T</sub>	Transition Frequency	V <sub>CE</sub> = 3V, I <sub>C</sub> = 15mA		12		GHz
C <sub>CB</sub>	Collector-Base Capacitance	V <sub>CB</sub> = 10V, f = 1MHz		0.47		pF

**Performance Characteristics**

SYMBOL	PARAMETER	CONDITION	VALUE			Unit
			min	typ	max	
[S <sub>21</sub> ] <sup>2</sup>	Insertion Power Gain	V <sub>CE</sub> =3V, I <sub>C</sub> =5mA, f=1GHz		13		dB
		V <sub>CE</sub> =3V, I <sub>C</sub> =15mA, f=1GHz		14.5		
		V <sub>CE</sub> =3V, I <sub>C</sub> =5mA, f=2GHz		7.5		
		V <sub>CE</sub> =3V, I <sub>C</sub> =15mA, f=2GHz		8.5		
MSG	Maximum Stable Gain	V <sub>CE</sub> =3V, I <sub>C</sub> =5mA, f=1GHz		16		dB
		V <sub>CE</sub> =3V, I <sub>C</sub> =15mA, f=1GHz		16.5		
MAG	Maximum Available Gain	V <sub>CE</sub> =3V, I <sub>C</sub> =5mA, f=2GHz		10.5		dB
		V <sub>CE</sub> =3V, I <sub>C</sub> =15mA, f=2GHz		11		
NF <sub>min</sub>	Minium Noise Figure	V <sub>CE</sub> =3V, I <sub>C</sub> =5mA, f=1GHz		1.1		dB
		V <sub>CE</sub> =3V, I <sub>C</sub> =5mA, f=2GHz		1.5		
r <sub>n</sub>	Noise Resistance	V <sub>CE</sub> =3V, I <sub>C</sub> =5mA, f=1GHz		0.06		
		V <sub>CE</sub> =3V, I <sub>C</sub> =5mA, f=2GHz		0.04		
G <sub>A</sub>	Associated Gain	V <sub>CE</sub> =3V, I <sub>C</sub> =5mA, f=1GHz		14		dB
		V <sub>CE</sub> =3V, I <sub>C</sub> =15mA, f=1GHz		15.5		
		V <sub>CE</sub> =3V, I <sub>C</sub> =5mA, f=2GHz		9.5		
		V <sub>CE</sub> =3V, I <sub>C</sub> =15mA, f=2GHz		10.5		
P <sub>-1dB</sub>	1dB Compression point	V <sub>CE</sub> =3V, I <sub>C</sub> =15mA, f=1GHz (Z <sub>s</sub> =Z <sub>sopt</sub> , Z <sub>L</sub> =Z <sub>Lopt</sub> )		10		dBm

**Total power dissipation  $P_t = f(T_A)$**

(  $T_A = 25$  )

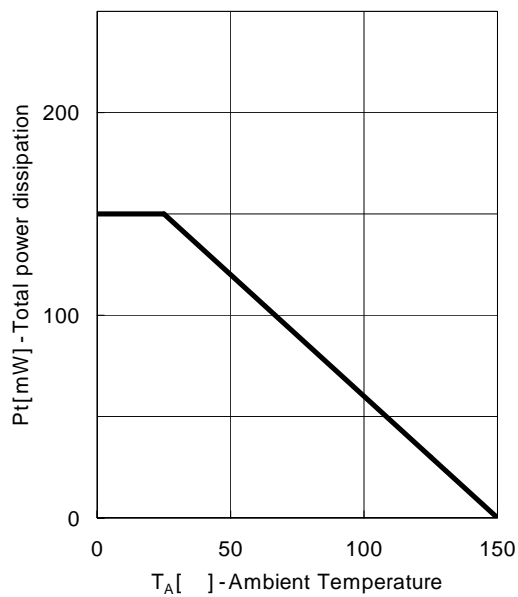

**$I_{CE}$  vs.  $V_{CE}$**

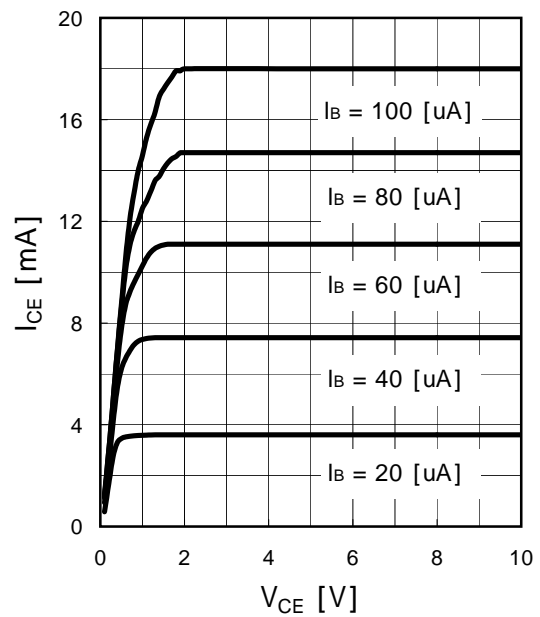

**$I_{CC}$  vs.  $V_{BE}$**

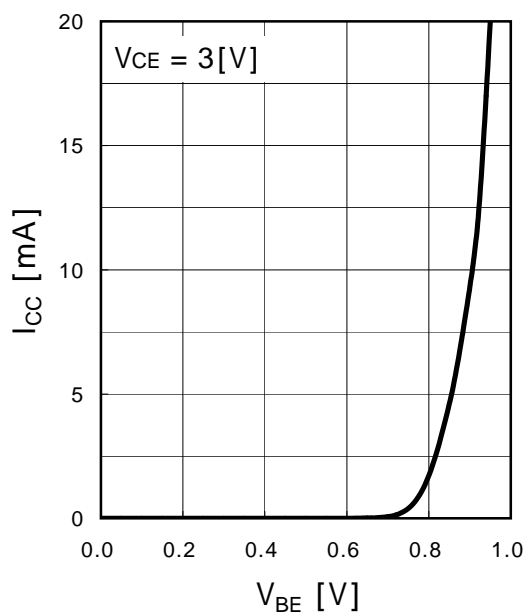

**$h_{fe}$  vs.  $I_{CC}$**

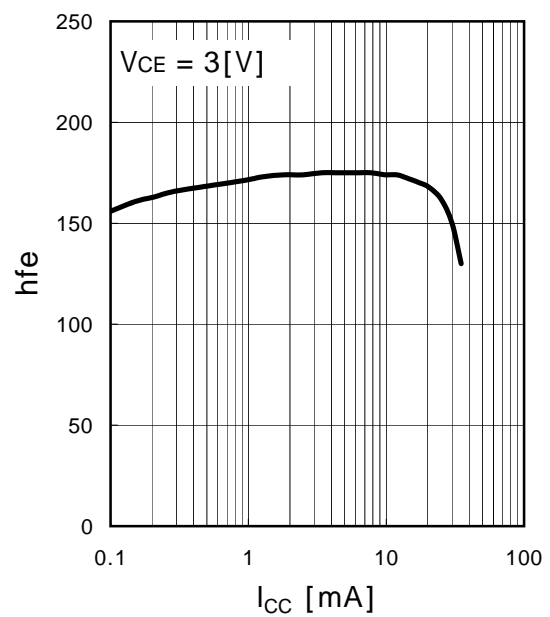

Power Gain : MSG vs. Frequency

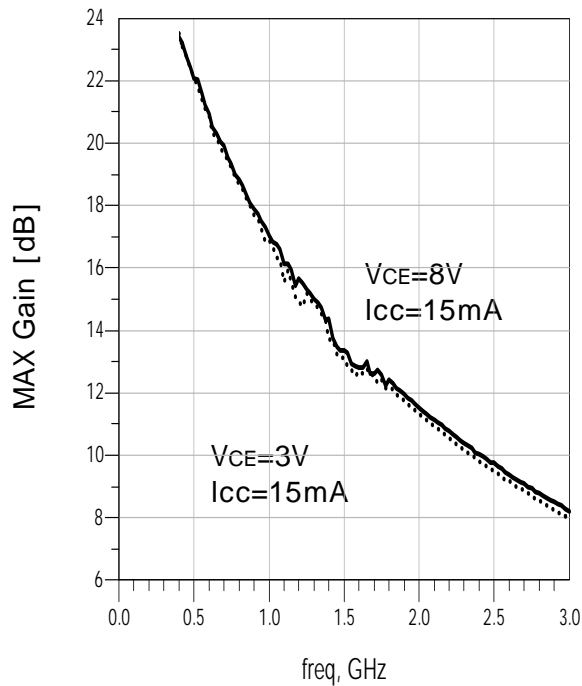

Power Gain : S<sub>21</sub> vs. Frequency

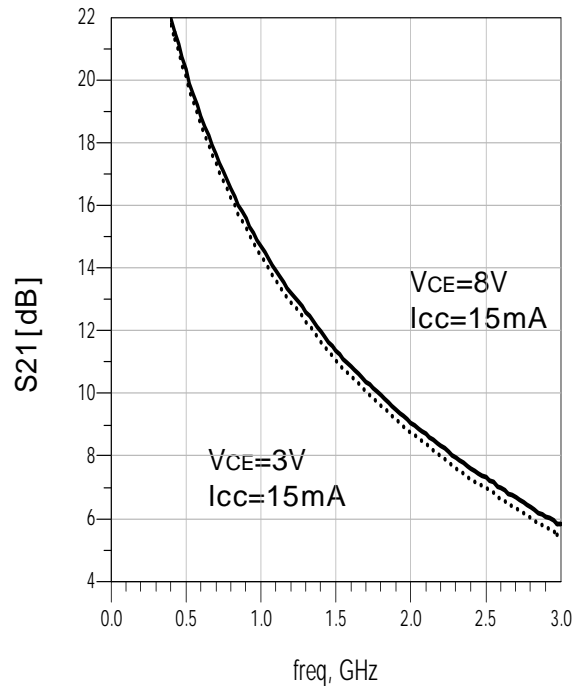

Power Gain : Gmax vs. Icc

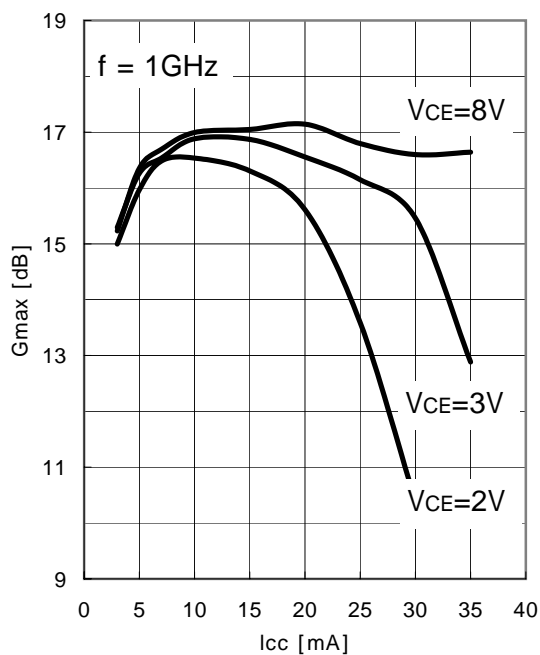

Power Gain : Gmax vs. Icc

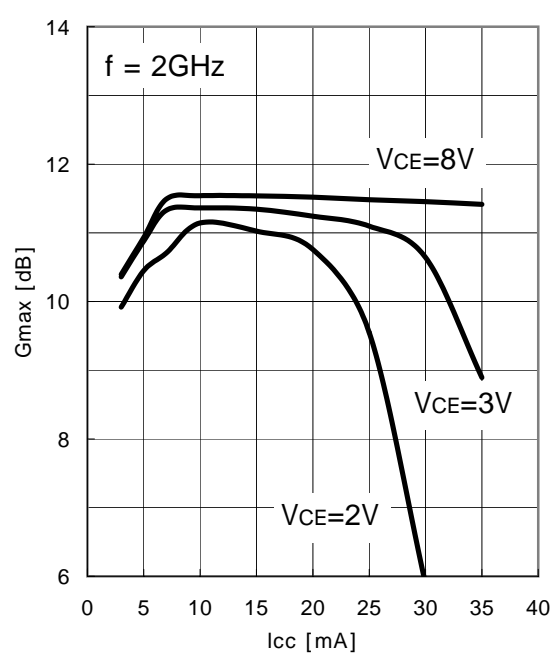

Transition Frequency :  $f_T$  vs.  $I_{CC}$

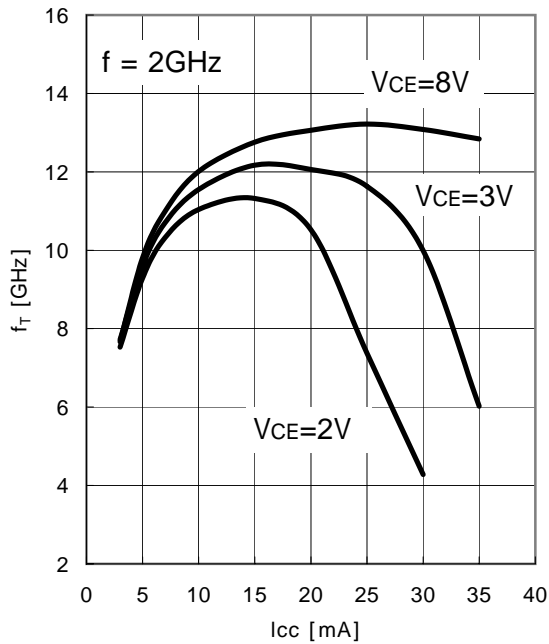

$C_{CB}$  vs.  $V_{CB}$

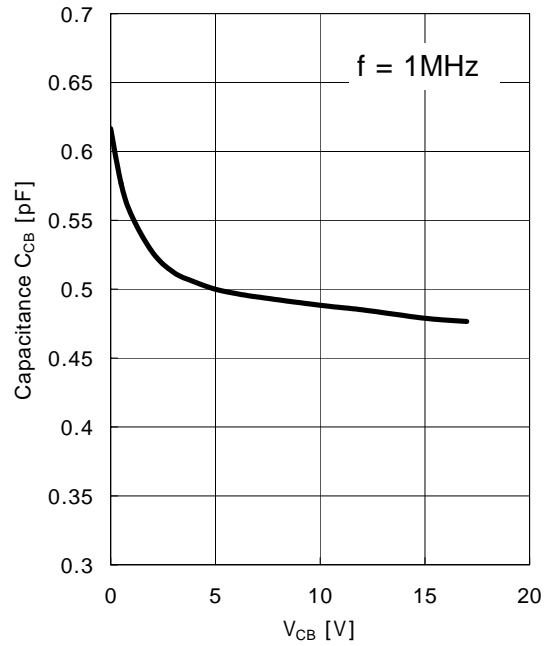

$F_{min}$  vs.  $I_{CC}$

$V_{CE} = 3V$ ,  $I_{CC} = \text{parameter}$ ,  $Z_s = Z_{opt}$

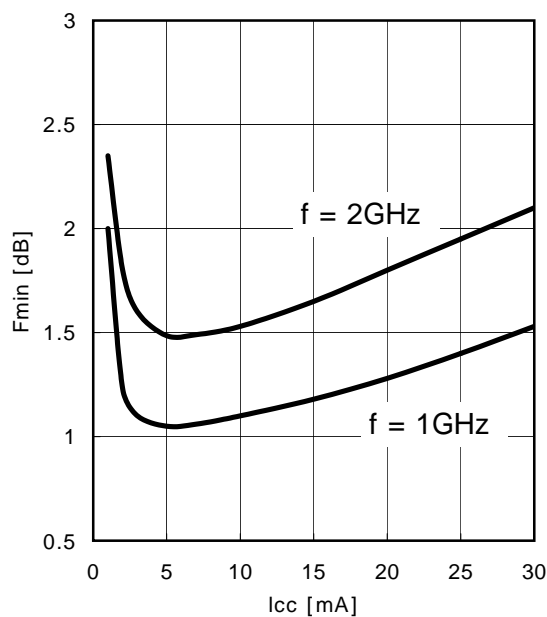

Noise Figure Contours & Constant Gain

$f = 1$  GHz, 2GHz,  $V_{CE} = 3V$ ,  $I_{CC} = 5\text{mA}$

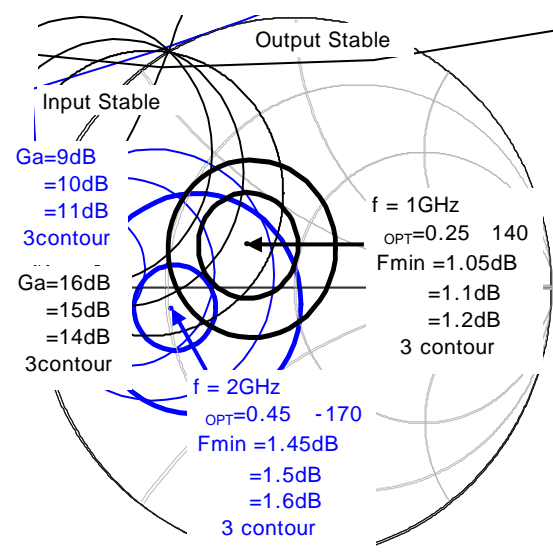

**Common Emitter S-Parameter Data**
**V<sub>CE</sub> = 3V, I<sub>CC</sub> = 3mA**

freq	S(1,1)	S(2,1)	S(1,2)	S(2,2)
400.0MHz	0.672 / -69.853	7.425 / 121.801	0.086 / 49.524	0.713 / -50.577
600.0MHz	0.557 / -91.576	5.796 / 105.689	0.101 / 42.921	0.600 / -64.541
800.0MHz	0.481 / -109.239	4.695 / 93.300	0.110 / 41.367	0.517 / -74.497
1.000GHz	0.433 / -124.432	3.916 / 83.290	0.116 / 41.041	0.469 / -83.018
1.200GHz	0.401 / -136.583	3.342 / 75.206	0.121 / 42.273	0.449 / -88.636
1.400GHz	0.386 / -149.283	2.933 / 66.935	0.129 / 45.128	0.437 / -97.156
1.600GHz	0.380 / -159.856	2.602 / 60.243	0.137 / 47.344	0.430 / -103.130
1.800GHz	0.380 / -169.844	2.346 / 53.700	0.148 / 50.277	0.434 / -108.304
2.000GHz	0.391 / -178.413	2.125 / 47.704	0.160 / 51.892	0.445 / -114.257
2.200GHz	0.400 / 172.606	1.955 / 41.833	0.178 / 53.316	0.453 / -120.476
2.400GHz	0.414 / 165.717	1.796 / 36.769	0.194 / 54.365	0.467 / -126.181
2.600GHz	0.433 / 159.146	1.669 / 31.270	0.215 / 54.158	0.483 / -132.697
2.800GHz	0.446 / 151.000	1.547 / 26.334	0.236 / 54.223	0.503 / -136.139
3.000GHz	0.459 / 144.921	1.442 / 22.172	0.255 / 53.296	0.526 / -142.384

**V<sub>CE</sub> = 3V, I<sub>CC</sub> = 5mA**

freq	S(1,1)	S(2,1)	S(1,2)	S(2,2)
400.0MHz	0.552 / -84.796	9.445 / 113.412	0.074 / 50.936	0.592 / -58.954
600.0MHz	0.448 / -107.816	6.991 / 98.963	0.085 / 46.494	0.479 / -71.103
800.0MHz	0.393 / -125.380	5.509 / 88.255	0.097 / 48.405	0.410 / -79.949
1.000GHz	0.361 / -140.158	4.521 / 79.531	0.107 / 50.162	0.372 / -87.799
1.200GHz	0.342 / -151.976	3.830 / 72.639	0.120 / 52.514	0.362 / -92.032
1.400GHz	0.335 / -163.805	3.338 / 65.313	0.132 / 53.439	0.356 / -100.484
1.600GHz	0.338 / -173.095	2.953 / 59.405	0.147 / 54.079	0.357 / -106.170
1.800GHz	0.345 / 177.666	2.658 / 53.436	0.161 / 55.178	0.365 / -110.954
2.000GHz	0.355 / 170.308	2.406 / 48.078	0.178 / 55.026	0.374 / -116.870
2.200GHz	0.368 / 162.766	2.209 / 42.668	0.196 / 55.012	0.385 / -122.906
2.400GHz	0.382 / 156.496	2.031 / 37.973	0.215 / 54.902	0.400 / -128.238
2.600GHz	0.402 / 150.777	1.893 / 32.845	0.234 / 54.371	0.417 / -134.789
2.800GHz	0.415 / 143.627	1.758 / 28.087	0.255 / 52.696	0.435 / -137.180
3.000GHz	0.427 / 138.024	1.645 / 24.166	0.274 / 51.524	0.460 / -143.512

**V<sub>CE</sub> = 3V, I<sub>CC</sub> = 7mA**

freq	S(1,1)	S(2,1)	S(1,2)	S(2,2)
400.0MHz	0.470 / -96.810	10.595 / 108.097	0.065 / 50.062	0.507 / -63.616
600.0MHz	0.392 / -119.503	7.632 / 95.010	0.079 / 52.208	0.405 / -74.604
800.0MHz	0.351 / -136.593	5.934 / 85.389	0.092 / 53.172	0.349 / -82.807
1.000GHz	0.330 / -151.052	4.835 / 77.520	0.107 / 55.943	0.317 / -91.237
1.200GHz	0.318 / -162.082	4.083 / 71.149	0.120 / 56.951	0.315 / -94.359
1.400GHz	0.319 / -173.098	3.548 / 64.399	0.139 / 57.265	0.313 / -103.037
1.600GHz	0.324 / 178.372	3.134 / 58.887	0.152 / 57.958	0.315 / -108.289
1.800GHz	0.332 / 170.226	2.818 / 53.285	0.170 / 57.172	0.327 / -112.652
2.000GHz	0.346 / 163.662	2.550 / 48.208	0.188 / 57.461	0.338 / -118.589
2.200GHz	0.359 / 156.317	2.342 / 43.116	0.205 / 56.110	0.350 / -124.789
2.400GHz	0.373 / 150.985	2.153 / 38.677	0.225 / 55.454	0.366 / -129.894
2.600GHz	0.391 / 145.867	2.006 / 33.678	0.245 / 54.016	0.383 / -135.965
2.800GHz	0.405 / 139.472	1.865 / 29.169	0.263 / 52.424	0.403 / -138.206
3.000GHz	0.416 / 133.982	1.749 / 25.312	0.283 / 50.273	0.428 / -144.746

**V<sub>CE</sub> = 3V, I<sub>CC</sub> = 10mA**

freq	S(1,1)	S(2,1)	S(1,2)	S(2,2)
400.0MHz	0.404 / -110.131	11.573 / 102.942	0.059 / 54.698	0.422 / -68.061
600.0MHz	0.346 / -132.444	8.146 / 91.370	0.074 / 56.910	0.336 / -78.359
800.0MHz	0.324 / -148.827	6.277 / 82.778	0.091 / 60.129	0.292 / -85.019
1.000GHz	0.310 / -161.802	5.088 / 75.604	0.104 / 61.320	0.272 / -93.459
1.200GHz	0.305 / -171.940	4.287 / 69.795	0.123 / 61.085	0.275 / -96.616
1.400GHz	0.311 / 178.486	3.718 / 63.476	0.141 / 60.512	0.277 / -104.685
1.600GHz	0.319 / 170.440	3.281 / 58.325	0.159 / 60.585	0.283 / -110.350
1.800GHz	0.328 / 163.134	2.947 / 53.041	0.178 / 59.304	0.296 / -114.411
2.000GHz	0.344 / 157.312	2.665 / 48.247	0.195 / 58.392	0.308 / -120.506
2.200GHz	0.356 / 150.620	2.449 / 43.362	0.214 / 56.777	0.321 / -126.307
2.400GHz	0.369 / 145.805	2.252 / 39.109	0.234 / 56.029	0.337 / -131.582
2.600GHz	0.388 / 141.156	2.100 / 34.352	0.254 / 54.151	0.355 / -137.681
2.800GHz	0.400 / 135.002	1.952 / 29.874	0.273 / 52.053	0.375 / -139.842
3.000GHz	0.412 / 130.236	1.832 / 26.213	0.291 / 50.131	0.399 / -146.125

V<sub>CE</sub> = 3V, I<sub>CC</sub> = 15mA

freq	S(1,1)	S(2,1)	S(1,2)	S(2,2)
400.0MHz	0.352 / -125.562	12.243 / 98.163	0.055 / 59.406	0.343 / -71.620
600.0MHz	0.319 / -146.130	8.481 / 88.001	0.070 / 62.637	0.277 / -80.243
800.0MHz	0.309 / -160.636	6.491 / 80.300	0.088 / 64.069	0.246 / -86.788
1.000GHz	0.308 / -171.726	5.241 / 73.796	0.108 / 64.730	0.234 / -94.594
1.200GHz	0.305 / 178.901	4.407 / 68.425	0.125 / 65.589	0.237 / -97.418
1.400GHz	0.313 / 170.936	3.821 / 62.417	0.144 / 63.798	0.248 / -105.854
1.600GHz	0.324 / 163.944	3.367 / 57.529	0.162 / 62.490	0.256 / -111.358
1.800GHz	0.335 / 157.063	3.023 / 52.485	0.183 / 61.428	0.272 / -115.820
2.000GHz	0.348 / 151.844	2.735 / 47.882	0.201 / 60.055	0.286 / -121.597
2.200GHz	0.362 / 146.056	2.510 / 43.135	0.221 / 58.031	0.301 / -127.612
2.400GHz	0.374 / 141.634	2.308 / 39.031	0.241 / 56.491	0.318 / -133.013
2.600GHz	0.392 / 137.171	2.151 / 34.397	0.261 / 54.083	0.334 / -139.054
2.800GHz	0.408 / 131.346	2.001 / 30.221	0.279 / 52.227	0.357 / -140.978
3.000GHz	0.417 / 126.608	1.878 / 26.498	0.298 / 49.998	0.381 / -146.868

V<sub>CE</sub> = 3V, I<sub>CC</sub> = 20mA

freq	S(1,1)	S(2,1)	S(1,2)	S(2,2)
400.0MHz	0.333 / -136.038	12.381 / 95.438	0.050 / 62.754	0.294 / -72.194
600.0MHz	0.317 / -155.212	8.517 / 86.062	0.070 / 64.751	0.246 / -79.559
800.0MHz	0.313 / -167.587	6.500 / 78.785	0.087 / 66.511	0.223 / -85.460
1.000GHz	0.316 / -177.856	5.238 / 72.534	0.107 / 66.680	0.215 / -94.151
1.200GHz	0.316 / 173.834	4.403 / 67.317	0.126 / 66.348	0.224 / -96.404
1.400GHz	0.324 / 166.606	3.811 / 61.425	0.147 / 65.080	0.234 / -105.422
1.600GHz	0.337 / 160.095	3.359 / 56.701	0.166 / 63.966	0.246 / -111.086
1.800GHz	0.347 / 154.008	3.014 / 51.714	0.185 / 62.160	0.263 / -115.461
2.000GHz	0.361 / 149.174	2.727 / 47.145	0.205 / 60.464	0.278 / -121.416
2.200GHz	0.375 / 143.533	2.502 / 42.437	0.225 / 58.579	0.295 / -127.375
2.400GHz	0.388 / 139.320	2.300 / 38.373	0.245 / 56.836	0.313 / -132.827
2.600GHz	0.406 / 135.160	2.142 / 33.836	0.265 / 54.859	0.330 / -139.158
2.800GHz	0.420 / 129.545	1.995 / 29.586	0.284 / 52.647	0.351 / -140.867
3.000GHz	0.431 / 125.082	1.872 / 26.030	0.300 / 50.341	0.378 / -147.420

V<sub>CE</sub> = 3V, I<sub>CC</sub> = 25mA

freq	S(1,1)	S(2,1)	S(1,2)	S(2,2)
400.0MHz	0.333 / -145.406	12.179 / 93.372	0.048 / 63.039	0.262 / -70.384
600.0MHz	0.327 / -161.685	8.342 / 84.464	0.068 / 68.381	0.228 / -77.110
800.0MHz	0.328 / -173.143	6.356 / 77.399	0.087 / 68.109	0.210 / -83.407
1.000GHz	0.333 / 178.315	5.118 / 71.239	0.107 / 69.087	0.207 / -91.366
1.200GHz	0.334 / 170.497	4.300 / 66.107	0.127 / 68.043	0.220 / -94.722
1.400GHz	0.346 / 163.441	3.719 / 60.275	0.146 / 67.205	0.233 / -104.039
1.600GHz	0.357 / 157.446	3.277 / 55.455	0.166 / 64.760	0.245 / -109.269
1.800GHz	0.368 / 151.870	2.939 / 50.472	0.187 / 63.175	0.264 / -113.969
2.000GHz	0.383 / 147.309	2.655 / 45.955	0.206 / 61.591	0.282 / -120.399
2.200GHz	0.397 / 141.586	2.438 / 41.215	0.227 / 59.462	0.297 / -126.442
2.400GHz	0.409 / 137.891	2.240 / 37.139	0.248 / 57.796	0.316 / -132.262
2.600GHz	0.425 / 133.838	2.087 / 32.533	0.269 / 55.037	0.334 / -138.492
2.800GHz	0.440 / 128.131	1.939 / 28.296	0.289 / 53.194	0.357 / -140.438
3.000GHz	0.449 / 123.982	1.818 / 24.714	0.306 / 50.255	0.384 / -146.821

V<sub>CE</sub> = 3V, I<sub>CC</sub> = 30mA

freq	S(1,1)	S(2,1)	S(1,2)	S(2,2)
400.0MHz	0.368 / -155.958	11.135 / 90.724	0.046 / 67.791	0.248 / -65.130
600.0MHz	0.374 / -169.685	7.605 / 82.121	0.067 / 69.688	0.222 / -70.534
800.0MHz	0.376 / -179.325	5.780 / 75.117	0.085 / 69.709	0.211 / -76.579
1.000GHz	0.383 / 173.164	4.646 / 68.843	0.106 / 71.009	0.212 / -85.150
1.200GHz	0.383 / 166.398	3.908 / 63.581	0.124 / 70.499	0.232 / -89.029
1.400GHz	0.397 / 160.044	3.376 / 57.589	0.146 / 68.867	0.248 / -98.801
1.600GHz	0.410 / 154.528	2.973 / 52.628	0.168 / 66.964	0.262 / -105.280
1.800GHz	0.421 / 149.128	2.662 / 47.514	0.187 / 65.288	0.284 / -110.678
2.000GHz	0.436 / 144.853	2.405 / 42.836	0.208 / 63.361	0.302 / -117.140
2.200GHz	0.451 / 139.716	2.203 / 38.070	0.229 / 61.100	0.321 / -124.051
2.400GHz	0.461 / 135.653	2.022 / 33.850	0.251 / 59.335	0.343 / -129.649
2.600GHz	0.479 / 131.534	1.881 / 29.197	0.273 / 56.498	0.363 / -136.622
2.800GHz	0.493 / 126.017	1.744 / 24.947	0.293 / 54.478	0.389 / -139.155
3.000GHz	0.501 / 121.931	1.633 / 21.405	0.312 / 51.983	0.416 / -145.907

V<sub>CE</sub> = 6V, I<sub>CC</sub> = 3mA

freq	S(1,1)	S(2,1)	S(1,2)	S(2,2)
400.0MHz	0.684 / -67.167	7.330 / 123.016	0.086 / 51.950	0.731 / -49.206
600.0MHz	0.567 / -89.038	5.773 / 106.800	0.103 / 43.777	0.610 / -63.617
800.0MHz	0.489 / -106.420	4.691 / 94.346	0.110 / 40.817	0.529 / -73.536
1.000GHz	0.436 / -121.698	3.925 / 84.160	0.116 / 41.034	0.480 / -82.399
1.200GHz	0.403 / -133.960	3.354 / 76.004	0.123 / 42.073	0.457 / -87.658
1.400GHz	0.384 / -146.639	2.948 / 67.700	0.127 / 44.009	0.444 / -96.203
1.600GHz	0.380 / -157.198	2.616 / 60.938	0.136 / 46.037	0.437 / -102.503
1.800GHz	0.378 / -167.490	2.363 / 54.303	0.146 / 49.080	0.442 / -107.656
2.000GHz	0.386 / -176.437	2.141 / 48.345	0.159 / 51.351	0.449 / -113.673
2.200GHz	0.397 / 174.507	1.969 / 42.471	0.174 / 53.080	0.458 / -119.921
2.400GHz	0.408 / 167.170	1.809 / 37.339	0.192 / 54.397	0.469 / -125.448
2.600GHz	0.427 / 160.400	1.682 / 31.806	0.211 / 54.594	0.486 / -132.040
2.800GHz	0.441 / 152.534	1.559 / 26.818	0.232 / 54.591	0.504 / -135.369
3.000GHz	0.454 / 145.946	1.453 / 22.687	0.253 / 53.660	0.528 / -141.906

V<sub>CE</sub> = 6V, I<sub>CC</sub> = 5mA

freq	S(1,1)	S(2,1)	S(1,2)	S(2,2)
400.0MHz	0.560 / -81.940	9.407 / 114.753	0.075 / 48.863	0.608 / -57.656
600.0MHz	0.456 / -104.462	7.009 / 100.131	0.088 / 47.313	0.493 / -69.832
800.0MHz	0.396 / -122.367	5.544 / 89.251	0.099 / 47.957	0.423 / -78.814
1.000GHz	0.359 / -136.967	4.561 / 80.435	0.107 / 49.630	0.381 / -87.046
1.200GHz	0.337 / -148.754	3.865 / 73.418	0.118 / 52.104	0.368 / -91.659
1.400GHz	0.331 / -160.848	3.371 / 66.074	0.132 / 52.517	0.362 / -99.653
1.600GHz	0.332 / -170.574	2.982 / 60.152	0.144 / 53.978	0.361 / -105.270
1.800GHz	0.336 / -179.687	2.686 / 54.137	0.159 / 54.599	0.368 / -110.048
2.000GHz	0.349 / 172.243	2.432 / 48.734	0.176 / 55.067	0.379 / -115.989
2.200GHz	0.360 / 164.225	2.235 / 43.339	0.194 / 55.213	0.388 / -121.939
2.400GHz	0.375 / 158.023	2.055 / 38.632	0.212 / 55.049	0.402 / -127.102
2.600GHz	0.394 / 152.193	1.914 / 33.463	0.230 / 54.122	0.419 / -133.579
2.800GHz	0.405 / 145.024	1.778 / 28.630	0.252 / 52.974	0.438 / -136.535
3.000GHz	0.417 / 139.429	1.665 / 24.718	0.271 / 51.436	0.462 / -142.787

V<sub>CE</sub> = 6V, I<sub>CC</sub> = 7mA

freq	S(1,1)	S(2,1)	S(1,2)	S(2,2)
400.0MHz	0.478 / -93.572	10.699 / 109.098	0.066 / 52.630	0.521 / -63.190
600.0MHz	0.391 / -116.368	7.742 / 95.877	0.079 / 52.029	0.414 / -74.299
800.0MHz	0.345 / -133.783	6.030 / 86.163	0.092 / 53.394	0.353 / -82.258
1.000GHz	0.324 / -148.386	4.919 / 78.255	0.105 / 54.876	0.324 / -89.957
1.200GHz	0.309 / -159.726	4.154 / 71.885	0.120 / 56.809	0.319 / -93.775
1.400GHz	0.309 / -170.808	3.614 / 65.082	0.134 / 57.495	0.316 / -102.046
1.600GHz	0.315 / -179.753	3.192 / 59.593	0.152 / 57.917	0.318 / -107.359
1.800GHz	0.320 / 171.949	2.871 / 54.027	0.168 / 57.261	0.328 / -111.907
2.000GHz	0.333 / 164.999	2.599 / 48.949	0.185 / 56.731	0.336 / -117.711
2.200GHz	0.346 / 157.728	2.387 / 43.844	0.203 / 56.372	0.350 / -123.852
2.400GHz	0.360 / 152.213	2.195 / 39.394	0.223 / 55.352	0.365 / -129.056
2.600GHz	0.380 / 146.939	2.048 / 34.447	0.243 / 54.282	0.381 / -135.331
2.800GHz	0.391 / 140.048	1.904 / 29.853	0.260 / 52.234	0.400 / -137.666
3.000GHz	0.403 / 134.840	1.784 / 26.017	0.279 / 50.926	0.424 / -144.091

V<sub>CE</sub> = 6V, I<sub>CC</sub> = 10mA

freq	S(1,1)	S(2,1)	S(1,2)	S(2,2)
400.0MHz	0.408 / -105.019	11.684 / 104.400	0.058 / 57.256	0.442 / -66.954
600.0MHz	0.345 / -127.906	8.269 / 92.508	0.075 / 55.384	0.349 / -77.493
800.0MHz	0.315 / -144.375	6.387 / 83.772	0.091 / 58.637	0.301 / -84.720
1.000GHz	0.302 / -157.930	5.185 / 76.531	0.105 / 60.513	0.278 / -92.294
1.200GHz	0.295 / -168.671	4.367 / 70.672	0.123 / 60.403	0.278 / -95.632
1.400GHz	0.297 / -178.550	3.791 / 64.326	0.139 / 60.965	0.279 / -104.255
1.600GHz	0.305 / 173.385	3.345 / 59.153	0.156 / 60.416	0.286 / -109.674
1.800GHz	0.312 / 165.512	3.007 / 53.881	0.175 / 59.317	0.298 / -113.738
2.000GHz	0.327 / 159.141	2.720 / 49.087	0.193 / 58.192	0.308 / -119.635
2.200GHz	0.340 / 152.208	2.500 / 44.189	0.211 / 56.885	0.322 / -125.576
2.400GHz	0.353 / 147.339	2.298 / 39.960	0.231 / 55.618	0.337 / -130.756
2.600GHz	0.370 / 142.489	2.143 / 35.193	0.251 / 53.760	0.353 / -136.857
2.800GHz	0.384 / 136.285	1.995 / 30.746	0.270 / 52.158	0.374 / -138.879
3.000GHz	0.396 / 131.130	1.873 / 27.024	0.287 / 49.996	0.398 / -145.089



V<sub>CE</sub> = 6V, I<sub>CC</sub> = 15mA

freq	S(1,1)	S(2,1)	S(1,2)	S(2,2)
400.0MHz	0.347 / -119.082	12.513 / 99.784	0.052 / 59.122	0.360 / -70.340
600.0MHz	0.307 / -141.189	8.708 / 89.357	0.071 / 60.610	0.290 / -79.253
800.0MHz	0.293 / -156.180	6.678 / 81.498	0.088 / 62.994	0.254 / -86.108
1.000GHz	0.289 / -168.115	5.396 / 74.878	0.106 / 64.704	0.240 / -94.275
1.200GHz	0.283 / -177.575	4.543 / 69.528	0.125 / 63.956	0.245 / -97.119
1.400GHz	0.293 / 173.379	3.937 / 63.515	0.143 / 63.379	0.250 / -105.700
1.600GHz	0.301 / 165.981	3.471 / 58.669	0.162 / 61.990	0.257 / -110.851
1.800GHz	0.310 / 159.302	3.118 / 53.647	0.181 / 60.349	0.271 / -115.511
2.000GHz	0.327 / 153.754	2.820 / 49.076	0.200 / 59.661	0.283 / -121.099
2.200GHz	0.339 / 147.371	2.590 / 44.388	0.220 / 57.628	0.296 / -127.003
2.400GHz	0.352 / 142.732	2.382 / 40.276	0.239 / 55.942	0.314 / -132.158
2.600GHz	0.369 / 138.613	2.221 / 35.663	0.257 / 53.946	0.331 / -138.511
2.800GHz	0.384 / 132.280	2.066 / 31.369	0.277 / 51.702	0.349 / -140.268
3.000GHz	0.394 / 127.721	1.942 / 27.842	0.293 / 49.671	0.375 / -146.726

V<sub>CE</sub> = 6V, I<sub>CC</sub> = 20mA

freq	S(1,1)	S(2,1)	S(1,2)	S(2,2)
400.0MHz	0.318 / -130.745	12.901 / 96.900	0.053 / 61.538	0.315 / -72.610
600.0MHz	0.293 / -150.334	8.900 / 87.359	0.070 / 64.082	0.253 / -80.371
800.0MHz	0.288 / -163.831	6.801 / 80.045	0.089 / 66.576	0.227 / -86.387
1.000GHz	0.288 / -174.577	5.485 / 73.800	0.107 / 66.452	0.215 / -95.032
1.200GHz	0.288 / 176.981	4.615 / 68.648	0.128 / 66.288	0.226 / -97.181
1.400GHz	0.295 / 168.822	3.997 / 62.861	0.144 / 64.766	0.233 / -106.070
1.600GHz	0.306 / 161.710	3.523 / 58.184	0.164 / 63.509	0.242 / -111.302
1.800GHz	0.317 / 155.343	3.162 / 53.268	0.185 / 61.766	0.257 / -115.902
2.000GHz	0.332 / 150.350	2.861 / 48.821	0.205 / 60.082	0.271 / -121.782
2.200GHz	0.344 / 144.542	2.626 / 44.197	0.223 / 58.059	0.286 / -127.576
2.400GHz	0.358 / 140.220	2.415 / 40.187	0.243 / 56.156	0.302 / -132.981
2.600GHz	0.373 / 135.981	2.252 / 35.648	0.263 / 54.012	0.320 / -139.220
2.800GHz	0.388 / 130.390	2.097 / 31.433	0.282 / 51.858	0.341 / -140.713
3.000GHz	0.399 / 125.592	1.971 / 27.950	0.298 / 49.933	0.364 / -146.986

V<sub>CE</sub> = 6V, I<sub>CC</sub> = 25mA

freq	S(1,1)	S(2,1)	S(1,2)	S(2,2)
400.0MHz	0.304 / -138.067	13.017 / 95.031	0.048 / 64.664	0.282 / -72.274
600.0MHz	0.291 / -156.486	8.940 / 86.038	0.070 / 69.864	0.234 / -79.163
800.0MHz	0.291 / -168.797	6.820 / 79.001	0.087 / 68.755	0.213 / -85.568
1.000GHz	0.292 / -178.894	5.495 / 72.944	0.107 / 67.968	0.206 / -94.161
1.200GHz	0.290 / 173.226	4.621 / 67.920	0.127 / 68.087	0.216 / -96.143
1.400GHz	0.303 / 165.555	4.000 / 62.225	0.147 / 65.853	0.224 / -105.838
1.600GHz	0.314 / 159.012	3.526 / 57.623	0.165 / 64.279	0.235 / -110.725
1.800GHz	0.324 / 153.056	3.162 / 52.762	0.186 / 62.765	0.252 / -115.170
2.000GHz	0.340 / 148.422	2.859 / 48.349	0.206 / 60.610	0.266 / -121.312
2.200GHz	0.354 / 142.768	2.626 / 43.782	0.226 / 58.809	0.282 / -127.396
2.400GHz	0.364 / 138.749	2.414 / 39.794	0.245 / 56.715	0.299 / -132.608
2.600GHz	0.382 / 134.820	2.251 / 35.316	0.265 / 54.691	0.318 / -138.871
2.800GHz	0.395 / 128.760	2.097 / 31.109	0.284 / 52.181	0.337 / -140.459
3.000GHz	0.406 / 124.631	1.969 / 27.637	0.303 / 49.998	0.363 / -147.112

V<sub>CE</sub> = 6V, I<sub>CC</sub> = 30mA

freq	S(1,1)	S(2,1)	S(1,2)	S(2,2)
400.0MHz	0.299 / -143.379	12.989 / 93.990	0.047 / 63.967	0.266 / -70.494
600.0MHz	0.294 / -160.785	8.904 / 85.259	0.067 / 68.621	0.226 / -78.257
800.0MHz	0.295 / -172.206	6.785 / 78.376	0.087 / 68.245	0.206 / -84.267
1.000GHz	0.298 / 178.966	5.466 / 72.392	0.107 / 69.196	0.200 / -92.866
1.200GHz	0.300 / 170.889	4.592 / 67.413	0.127 / 69.200	0.213 / -94.943
1.400GHz	0.310 / 164.180	3.977 / 61.726	0.147 / 66.853	0.223 / -104.946
1.600GHz	0.322 / 158.029	3.504 / 57.093	0.168 / 65.013	0.235 / -109.709
1.800GHz	0.332 / 151.925	3.143 / 52.265	0.187 / 62.900	0.251 / -114.424
2.000GHz	0.348 / 147.494	2.842 / 47.845	0.207 / 61.247	0.266 / -120.692
2.200GHz	0.361 / 141.936	2.609 / 43.260	0.226 / 59.151	0.282 / -126.868
2.400GHz	0.373 / 137.905	2.397 / 39.275	0.247 / 57.126	0.299 / -132.076
2.600GHz	0.391 / 134.086	2.235 / 34.804	0.266 / 54.899	0.317 / -138.431
2.800GHz	0.404 / 128.201	2.080 / 30.595	0.286 / 52.673	0.338 / -139.943
3.000GHz	0.416 / 123.759	1.955 / 27.089	0.304 / 50.260	0.365 / -146.653

VCE = 6V, Icc = 35mA

freq	S(1,1)	S(2,1)	S(1,2)	S(2,2)
400.0MHz	0.307 / -149.464	12.763 / 92.634	0.047 / 66.533	0.252 / -68.882
600.0MHz	0.306 / -165.095	8.721 / 84.155	0.067 / 70.478	0.219 / -75.363
800.0MHz	0.310 / -175.578	6.641 / 77.368	0.088 / 69.272	0.203 / -80.474
1.000GHz	0.314 / 176.384	5.350 / 71.447	0.106 / 70.360	0.199 / -89.176
1.200GHz	0.316 / 168.703	4.493 / 66.494	0.127 / 69.964	0.213 / -92.272
1.400GHz	0.326 / 162.260	3.889 / 60.728	0.148 / 67.551	0.226 / -101.858
1.600GHz	0.339 / 156.165	3.424 / 56.091	0.167 / 66.018	0.239 / -107.374
1.800GHz	0.349 / 150.647	3.072 / 51.175	0.185 / 64.029	0.256 / -112.032
2.000GHz	0.366 / 146.422	2.775 / 46.756	0.207 / 61.965	0.272 / -118.414
2.200GHz	0.380 / 140.908	2.546 / 42.123	0.227 / 59.806	0.288 / -124.672
2.400GHz	0.392 / 137.204	2.339 / 38.116	0.248 / 57.972	0.307 / -130.286
2.600GHz	0.408 / 133.362	2.177 / 33.497	0.269 / 55.432	0.325 / -136.868
2.800GHz	0.423 / 127.785	2.026 / 29.303	0.287 / 53.124	0.349 / -139.137
3.000GHz	0.435 / 123.158	1.901 / 25.834	0.305 / 50.856	0.376 / -145.451

VCE = 8V, Icc = 3mA

freq	S(1,1)	S(2,1)	S(1,2)	S(2,2)
400.0MHz	0.692 / -66.045	7.235 / 123.666	0.088 / 51.646	0.733 / -48.856
600.0MHz	0.573 / -87.929	5.720 / 107.368	0.103 / 43.725	0.616 / -62.972
800.0MHz	0.494 / -105.270	4.659 / 94.803	0.110 / 40.635	0.536 / -72.901
1.000GHz	0.442 / -120.380	3.905 / 84.555	0.117 / 40.038	0.483 / -81.946
1.200GHz	0.405 / -132.774	3.340 / 76.331	0.122 / 41.435	0.464 / -87.190
1.400GHz	0.387 / -145.451	2.936 / 67.950	0.126 / 43.251	0.449 / -95.695
1.600GHz	0.381 / -155.938	2.606 / 61.198	0.134 / 46.519	0.441 / -101.812
1.800GHz	0.380 / -166.489	2.354 / 54.541	0.145 / 49.164	0.446 / -106.969
2.000GHz	0.388 / -175.560	2.135 / 48.540	0.157 / 51.271	0.451 / -113.049
2.200GHz	0.396 / 175.367	1.963 / 42.592	0.173 / 52.646	0.460 / -119.270
2.400GHz	0.411 / 168.149	1.803 / 37.472	0.190 / 54.315	0.474 / -124.979
2.600GHz	0.429 / 161.243	1.676 / 31.927	0.208 / 54.707	0.489 / -131.503
2.800GHz	0.441 / 153.006	1.553 / 26.885	0.231 / 54.106	0.507 / -134.706
3.000GHz	0.454 / 146.872	1.449 / 22.659	0.250 / 53.801	0.531 / -141.486

VCE = 8V, Icc = 5mA

freq	S(1,1)	S(2,1)	S(1,2)	S(2,2)
400.0MHz	0.558 / -81.688	9.506 / 114.675	0.070 / 52.224	0.603 / -57.209
600.0MHz	0.454 / -104.441	7.082 / 100.056	0.086 / 48.795	0.488 / -70.145
800.0MHz	0.391 / -122.017	5.593 / 89.277	0.097 / 47.163	0.417 / -78.413
1.000GHz	0.355 / -137.272	4.599 / 80.479	0.107 / 50.146	0.378 / -86.808
1.200GHz	0.334 / -148.636	3.897 / 73.500	0.118 / 51.711	0.365 / -91.086
1.400GHz	0.329 / -160.840	3.401 / 66.174	0.132 / 52.696	0.361 / -99.534
1.600GHz	0.327 / -170.460	3.008 / 60.246	0.144 / 54.415	0.358 / -105.284
1.800GHz	0.333 / -179.929	2.708 / 54.316	0.159 / 54.776	0.367 / -109.745
2.000GHz	0.346 / 172.096	2.453 / 48.951	0.175 / 55.311	0.376 / -115.570
2.200GHz	0.357 / 164.258	2.253 / 43.515	0.193 / 55.100	0.386 / -121.605
2.400GHz	0.371 / 158.159	2.074 / 38.829	0.212 / 54.964	0.399 / -126.959
2.600GHz	0.390 / 152.267	1.932 / 33.702	0.231 / 54.227	0.415 / -133.483
2.800GHz	0.403 / 145.019	1.796 / 28.944	0.251 / 52.818	0.435 / -136.122
3.000GHz	0.414 / 139.272	1.680 / 24.951	0.269 / 51.215	0.458 / -142.316

VCE = 8V, Icc = 7mA

freq	S(1,1)	S(2,1)	S(1,2)	S(2,2)
400.0MHz	0.471 / -93.680	10.759 / 109.241	0.067 / 53.822	0.515 / -62.510
600.0MHz	0.388 / -116.140	7.786 / 95.990	0.078 / 51.015	0.413 / -73.823
800.0MHz	0.343 / -133.532	6.069 / 86.296	0.092 / 54.273	0.353 / -81.488
1.000GHz	0.322 / -147.955	4.948 / 78.361	0.106 / 55.227	0.322 / -90.008
1.200GHz	0.305 / -159.302	4.182 / 72.000	0.120 / 57.585	0.318 / -93.233
1.400GHz	0.305 / -170.813	3.639 / 65.255	0.135 / 57.363	0.313 / -101.521
1.600GHz	0.310 / -179.325	3.215 / 59.755	0.150 / 57.311	0.316 / -106.969
1.800GHz	0.317 / 172.073	2.889 / 54.175	0.167 / 57.440	0.327 / -111.776
2.000GHz	0.330 / 165.125	2.617 / 49.140	0.186 / 56.704	0.335 / -117.340
2.200GHz	0.342 / 157.422	2.405 / 44.071	0.204 / 56.244	0.348 / -123.485
2.400GHz	0.357 / 152.276	2.211 / 39.574	0.221 / 54.971	0.362 / -128.588
2.600GHz	0.375 / 146.942	2.059 / 34.642	0.241 / 53.741	0.379 / -135.070
2.800GHz	0.389 / 140.218	1.915 / 30.080	0.261 / 52.515	0.398 / -137.202
3.000GHz	0.401 / 134.977	1.796 / 26.230	0.280 / 50.508	0.423 / -143.606

V<sub>CE</sub> = 8V, I<sub>CC</sub> = 10mA

freq	S(1,1)	S(2,1)	S(1,2)	S(2,2)
400.0MHz	0.404 / -105.567	11.755 / 104.478	0.059 / 54.322	0.436 / -67.261
600.0MHz	0.342 / -127.922	8.329 / 92.597	0.074 / 56.455	0.348 / -76.987
800.0MHz	0.311 / -144.385	6.436 / 83.843	0.088 / 59.237	0.300 / -84.139
1.000GHz	0.295 / -157.791	5.226 / 76.620	0.104 / 59.950	0.278 / -91.946
1.200GHz	0.289 / -168.627	4.402 / 70.834	0.122 / 61.650	0.276 / -95.110
1.400GHz	0.293 / -178.792	3.822 / 64.480	0.139 / 60.606	0.279 / -103.618
1.600GHz	0.300 / 173.073	3.371 / 59.332	0.157 / 60.099	0.283 / -108.888
1.800GHz	0.309 / 165.244	3.029 / 54.073	0.175 / 59.557	0.296 / -113.475
2.000GHz	0.323 / 158.795	2.744 / 49.297	0.192 / 58.062	0.306 / -119.274
2.200GHz	0.337 / 152.230	2.520 / 44.426	0.212 / 56.804	0.319 / -125.134
2.400GHz	0.351 / 147.141	2.318 / 40.183	0.231 / 55.555	0.333 / -130.451
2.600GHz	0.367 / 142.343	2.161 / 35.398	0.250 / 53.634	0.349 / -136.626
2.800GHz	0.381 / 136.139	2.012 / 31.029	0.270 / 52.148	0.369 / -138.400
3.000GHz	0.393 / 131.017	1.889 / 27.307	0.288 / 50.269	0.394 / -144.908

V<sub>CE</sub> = 8V, I<sub>CC</sub> = 15mA

freq	S(1,1)	S(2,1)	S(1,2)	S(2,2)
400.0MHz	0.345 / -118.562	12.574 / 100.060	0.057 / 58.146	0.356 / -71.005
600.0MHz	0.302 / -139.929	8.758 / 89.527	0.071 / 61.542	0.292 / -79.659
800.0MHz	0.290 / -155.577	6.717 / 81.695	0.088 / 62.295	0.255 / -85.825
1.000GHz	0.284 / -167.586	5.430 / 75.095	0.107 / 63.783	0.238 / -93.626
1.200GHz	0.281 / -177.067	4.571 / 69.699	0.124 / 63.788	0.244 / -96.796
1.400GHz	0.288 / 174.047	3.960 / 63.704	0.145 / 63.304	0.250 / -105.324
1.600GHz	0.298 / 166.001	3.494 / 58.878	0.161 / 61.839	0.255 / -110.491
1.800GHz	0.306 / 159.160	3.136 / 53.858	0.180 / 60.605	0.271 / -114.707
2.000GHz	0.322 / 153.704	2.837 / 49.294	0.199 / 59.119	0.282 / -120.913
2.200GHz	0.335 / 147.398	2.606 / 44.632	0.218 / 57.488	0.295 / -126.737
2.400GHz	0.348 / 143.090	2.396 / 40.495	0.239 / 55.889	0.312 / -131.781
2.600GHz	0.366 / 138.491	2.236 / 35.909	0.258 / 53.840	0.328 / -138.132
2.800GHz	0.381 / 132.538	2.081 / 31.618	0.276 / 51.948	0.348 / -139.796
3.000GHz	0.393 / 128.016	1.955 / 28.072	0.295 / 49.735	0.373 / -146.220

V<sub>CE</sub> = 8V, I<sub>CC</sub> = 20mA

freq	S(1,1)	S(2,1)	S(1,2)	S(2,2)
400.0MHz	0.318 / -127.588	12.933 / 97.580	0.052 / 64.883	0.321 / -72.440
600.0MHz	0.291 / -148.297	8.941 / 87.881	0.070 / 65.634	0.262 / -79.779
800.0MHz	0.284 / -162.308	6.836 / 80.463	0.086 / 65.587	0.233 / -86.040
1.000GHz	0.283 / -172.934	5.517 / 74.176	0.106 / 67.173	0.219 / -94.707
1.200GHz	0.282 / 177.479	4.641 / 68.987	0.127 / 66.201	0.227 / -96.679
1.400GHz	0.290 / 169.554	4.020 / 63.192	0.145 / 64.428	0.235 / -105.657
1.600GHz	0.300 / 162.073	3.544 / 58.491	0.163 / 63.105	0.246 / -110.846
1.800GHz	0.310 / 156.027	3.181 / 53.577	0.183 / 61.775	0.259 / -115.211
2.000GHz	0.325 / 150.904	2.877 / 49.110	0.203 / 59.780	0.270 / -121.200
2.200GHz	0.339 / 144.662	2.643 / 44.534	0.221 / 58.084	0.286 / -126.996
2.400GHz	0.351 / 140.419	2.431 / 40.483	0.242 / 55.914	0.301 / -132.531
2.600GHz	0.367 / 136.685	2.267 / 35.959	0.262 / 54.012	0.318 / -138.761
2.800GHz	0.381 / 130.423	2.111 / 31.761	0.280 / 51.990	0.338 / -139.973
3.000GHz	0.394 / 126.137	1.983 / 28.164	0.299 / 49.915	0.364 / -146.480

V<sub>CE</sub> = 8V, I<sub>CC</sub> = 25mA

freq	S(1,1)	S(2,1)	S(1,2)	S(2,2)
400.0MHz	0.302 / -134.847	13.087 / 95.926	0.049 / 63.925	0.291 / -72.046
600.0MHz	0.286 / -153.760	9.005 / 86.705	0.067 / 66.939	0.245 / -79.710
800.0MHz	0.283 / -167.437	6.875 / 79.594	0.087 / 66.903	0.217 / -85.575
1.000GHz	0.283 / -177.165	5.547 / 73.457	0.107 / 67.037	0.208 / -94.055
1.200GHz	0.284 / 174.359	4.661 / 68.410	0.126 / 66.604	0.219 / -96.324
1.400GHz	0.294 / 166.822	4.035 / 62.696	0.145 / 65.908	0.226 / -105.671
1.600GHz	0.304 / 160.105	3.557 / 58.053	0.165 / 64.125	0.238 / -110.353
1.800GHz	0.315 / 153.925	3.193 / 53.178	0.186 / 62.242	0.253 / -115.415
2.000GHz	0.331 / 149.126	2.887 / 48.788	0.205 / 60.750	0.266 / -120.958
2.200GHz	0.344 / 143.297	2.652 / 44.225	0.225 / 58.448	0.280 / -127.093
2.400GHz	0.355 / 139.265	2.438 / 40.235	0.244 / 56.588	0.298 / -132.332
2.600GHz	0.373 / 135.121	2.273 / 35.720	0.264 / 54.333	0.315 / -138.810
2.800GHz	0.386 / 129.012	2.118 / 31.533	0.283 / 51.958	0.335 / -140.312
3.000GHz	0.398 / 124.660	1.989 / 28.042	0.301 / 49.869	0.359 / -146.482

VCE = 8V, Icc = 30mA

freq	S(1,1)	S(2,1)	S(1,2)	S(2,2)
400.0MHz	0.297 / -141.412	13.106 / 94.688	0.049 / 66.005	0.276 / -70.987
600.0MHz	0.287 / -158.366	8.994 / 85.794	0.068 / 69.012	0.230 / -78.079
800.0MHz	0.287 / -170.529	6.858 / 78.840	0.088 / 69.303	0.209 / -84.179
1.000GHz	0.290 / -179.910	5.525 / 72.816	0.106 / 68.369	0.201 / -92.571
1.200GHz	0.289 / 172.060	4.650 / 67.842	0.127 / 68.912	0.215 / -94.979
1.400GHz	0.301 / 164.771	4.023 / 62.162	0.145 / 66.877	0.224 / -104.251
1.600GHz	0.313 / 158.344	3.543 / 57.559	0.165 / 64.835	0.234 / -109.566
1.800GHz	0.325 / 152.339	3.179 / 52.742	0.187 / 62.562	0.250 / -114.268
2.000GHz	0.337 / 147.697	2.875 / 48.335	0.206 / 60.903	0.264 / -120.313
2.200GHz	0.352 / 142.304	2.640 / 43.721	0.225 / 58.789	0.279 / -126.296
2.400GHz	0.364 / 138.337	2.426 / 39.774	0.245 / 56.923	0.298 / -131.594
2.600GHz	0.381 / 134.239	2.264 / 35.232	0.265 / 54.728	0.315 / -137.683
2.800GHz	0.396 / 128.725	2.105 / 31.051	0.283 / 52.397	0.336 / -139.367
3.000GHz	0.407 / 124.177	1.980 / 27.567	0.303 / 50.200	0.360 / -146.338

VCE = 8V, Icc = 35mA

freq	S(1,1)	S(2,1)	S(1,2)	S(2,2)
400.0MHz	0.299 / -145.135	13.024 / 93.762	0.049 / 67.969	0.264 / -70.266
600.0MHz	0.292 / -161.566	8.921 / 85.067	0.068 / 71.136	0.224 / -76.248
800.0MHz	0.294 / -173.213	6.798 / 78.227	0.087 / 69.398	0.205 / -82.071
1.000GHz	0.299 / 177.958	5.475 / 72.237	0.106 / 69.683	0.200 / -89.954
1.200GHz	0.301 / 170.231	4.599 / 67.257	0.125 / 68.659	0.211 / -92.947
1.400GHz	0.311 / 162.977	3.981 / 61.610	0.146 / 66.522	0.223 / -102.330
1.600GHz	0.322 / 157.363	3.506 / 56.974	0.165 / 65.077	0.235 / -108.193
1.800GHz	0.331 / 151.456	3.148 / 52.107	0.186 / 63.532	0.252 / -112.941
2.000GHz	0.348 / 146.830	2.846 / 47.717	0.206 / 61.258	0.267 / -119.145
2.200GHz	0.362 / 141.636	2.612 / 43.119	0.225 / 59.309	0.282 / -125.399
2.400GHz	0.373 / 137.691	2.400 / 39.158	0.246 / 57.084	0.300 / -130.878
2.600GHz	0.391 / 133.640	2.239 / 34.592	0.266 / 55.107	0.318 / -137.122
2.800GHz	0.403 / 127.851	2.083 / 30.419	0.286 / 52.727	0.339 / -138.973
3.000GHz	0.416 / 123.872	1.955 / 26.853	0.302 / 50.289	0.366 / -145.360

VCE = 8V, Icc = 40mA

freq	S(1,1)	S(2,1)	S(1,2)	S(2,2)
400.0MHz	0.306 / -150.063	12.785 / 92.859	0.048 / 66.381	0.253 / -67.480
600.0MHz	0.301 / -165.317	8.744 / 84.305	0.064 / 70.202	0.222 / -73.253
800.0MHz	0.307 / -175.851	6.661 / 77.481	0.086 / 69.795	0.207 / -78.593
1.000GHz	0.310 / 176.239	5.364 / 71.521	0.105 / 70.581	0.200 / -87.597
1.200GHz	0.313 / 168.674	4.506 / 66.496	0.127 / 69.264	0.218 / -89.884
1.400GHz	0.325 / 162.027	3.899 / 60.821	0.146 / 67.616	0.227 / -100.132
1.600GHz	0.335 / 156.279	3.435 / 56.143	0.166 / 66.589	0.240 / -105.812
1.800GHz	0.345 / 150.755	3.082 / 51.258	0.185 / 64.267	0.259 / -110.614
2.000GHz	0.362 / 146.162	2.786 / 46.807	0.207 / 62.304	0.274 / -117.309
2.200GHz	0.378 / 141.149	2.555 / 42.160	0.226 / 60.108	0.290 / -123.504
2.400GHz	0.390 / 137.011	2.347 / 38.147	0.246 / 58.032	0.308 / -129.473
2.600GHz	0.405 / 133.212	2.186 / 33.608	0.267 / 55.812	0.325 / -135.827
2.800GHz	0.422 / 127.560	2.033 / 29.412	0.285 / 53.277	0.351 / -137.714
3.000GHz	0.431 / 123.244	1.909 / 25.886	0.305 / 50.953	0.374 / -144.603