

75 Ω VIDEO LINE DRIVER

FEATURES

- Gain Set by External Components (6 dB typ.)
- Internal 75 Ω Drivers
- Active High ON/OFF Control
- Very Low Standby Current (typ. $I_{STBY} \leq 25 \mu A$)
- Single +5 V Power Supply Operation

APPLICATIONS

- RGB Video Line Driver Applications
- Video Equipment
- Digital Cameras
- CCD Cameras
- TV Monitors
- Video Tape Recorders
- LCD Projectors

DESCRIPTION

Operating from a single +5 V supply, the TK15402 is a triple video driver IC that takes standard video signals as analog inputs and provides buffered analog outputs for driving 150 Ω loads (series 75 Ω resistor and 75 Ω cable load). The standard video input signals (1 V_{p-p}) are typically amplified 6 dB using external components to produce a 2 V_{p-p} signal into an AC-coupled 150 Ω load. During standby (Pin 2 grounded), the TK15402 consumes only 113 μW of power. Nominal power dissipation (no input) is typically 98 mW.

The TK15402M is available in the SSOP-12 Surface Mount Package.

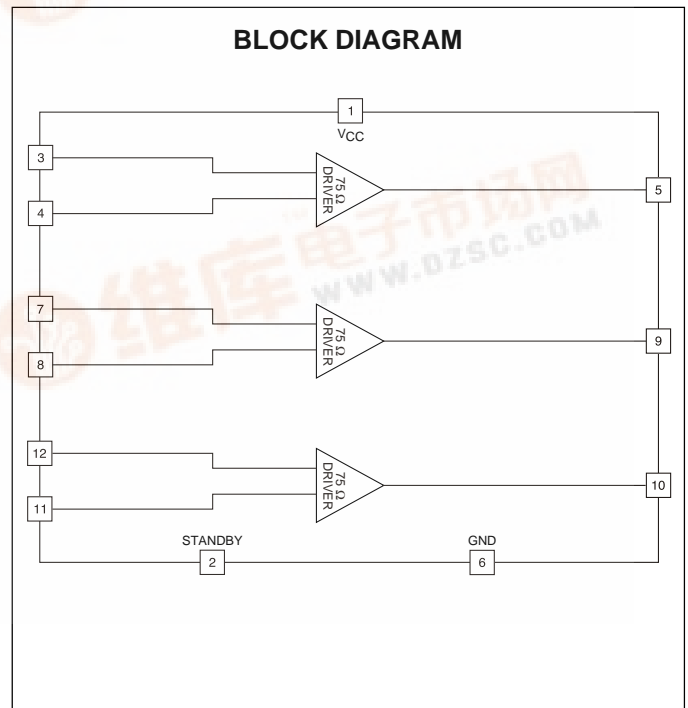
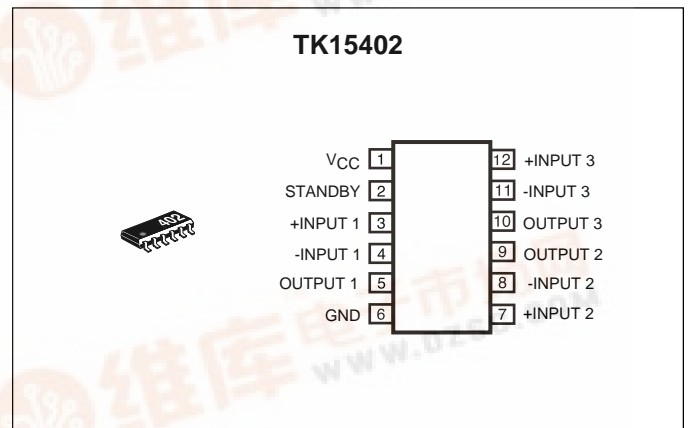

ORDERING INFORMATION

TK15402M Tape/Reel Code

TAPE/REEL CODE
TL: Tape Left



TK15402

ABSOLUTE MAXIMUM RATINGS

Supply Voltage 6 V Storage Temperature Range -55 to +150 °C
 Operating Voltage 4.5 to 5.5 V Operating Temperature Range -25 to +75 °C
 Power Dissipation (Note 1) 350 mW

TK15402M ELECTRICAL CHARACTERISTICS

Test conditions: $V_{CC} = 5.0\text{ V}$, $V_{IN} = 1.0\text{ V}_{P-P}$, $R_L = 150\ \Omega$, $T_A = 25\text{ °C}$ unless otherwise specified.

SYMBOL	PARAMETER	TEST CONDITIONS	MIN	TYP	MAX	UNITS
I_{CC}	Supply Current	No input		19.5	27.0	mA
I_{STBY}	Standby Supply Current	Pin 2 Grounded		22.5	50.0	μA
I_{OS}	Standby Terminal Current	Pin 2 Standby mode		22.5	50.0	μA
V_{THL}	Threshold Voltage (High to Low)	Pin 2 Operating to Standby mode	GND	0.1	0.3	V
V_{TLH}	Threshold Voltage (Low to High)	Pin 2 Standby to Operating mode	1.8	2.0	V_{CC}	V
GVA	Voltage Gain	$f_{in} = 1\text{ MHz}$ (Note 2)	5.7	6.0	6.3	dB
fr	Frequency Response	$f_{in} = 1\text{ MHz} / 5\text{ MHz}$		-0.1		dB
		$f_{in} = 1\text{ MHz} / 10\text{ MHz}$		-1.1		dB
THD	Total Harmonic Distortion	$f_{IN} = 1.0\text{ kHz}$		0.2	1.0	%
$V_{OUT(MAX)}$	Maximum Output Voltage	THD = 10% point	1.0	1.2		Vrms
CT	Cross Talk	$f_{in} = 1\text{ MHz}$		-55	-40	dB
S/N	Signal to Noise Ratio	Pedestal signal		-70		dB
DG	Differential Gain	Staircase wave input	-3.0		+3.0	%
DP	Differential Phase	Staircase wave input	-3.0		+3.0	deg
GVO	Open Circuit Voltage Gain			40		dB
BW	Frequency Band Width			20		MHz
SR	Slew Rate			70		V/ μS
C_{IN}	Input Capacitance			9		pF
R_{IN}	Input Resistance			1.6		M Ω

Note 1: Power dissipation is 350 mW in free air. Derate at 2.8 mW/°C for operation above 25°C.

Note 2: Set by external components.

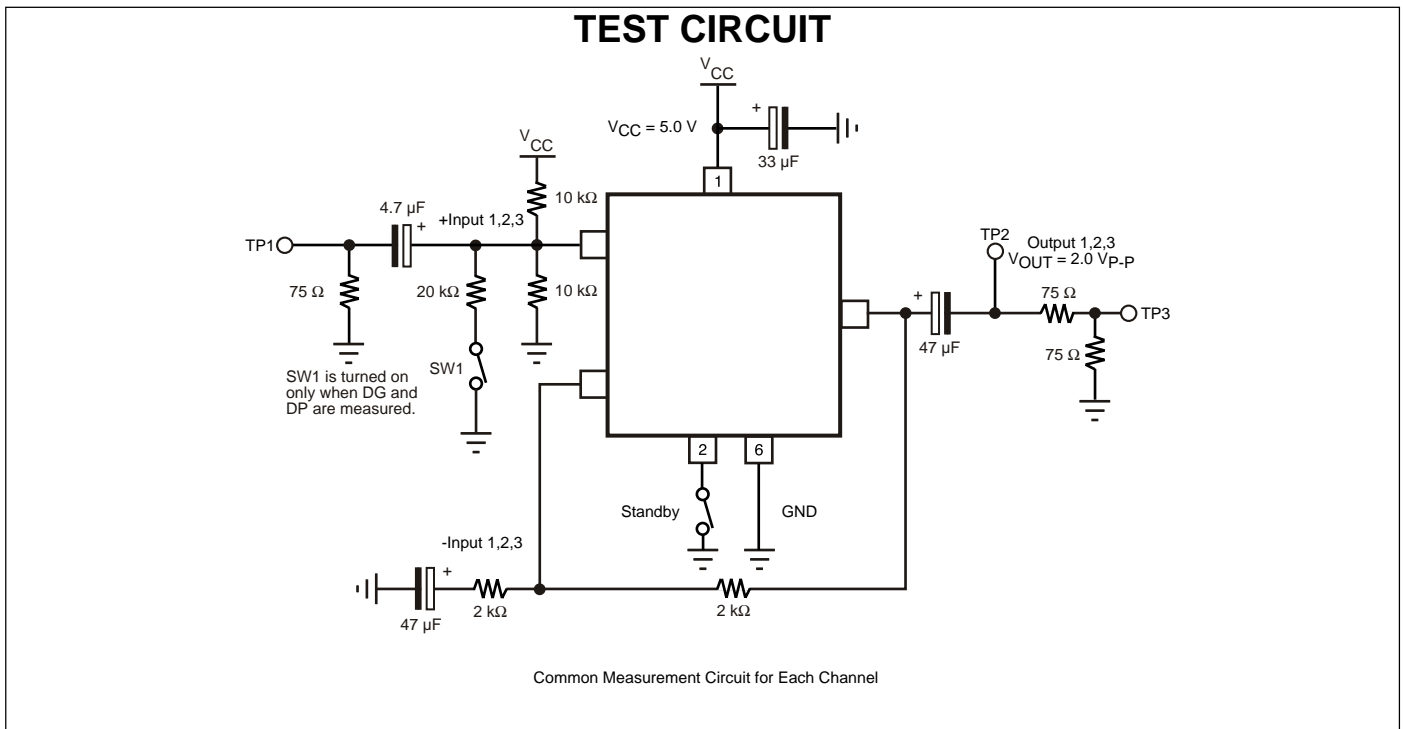

MEASUREMENT METHOD

1. Supply Current (I_{CC})

The Pin 1 current is measured with no input signal and the Standby Pin (Pin 2) open.

2. Standby Supply Current (I_{STBY})

The Pin 1 current is measured when the Standby Pin (Pin 2) is connected to ground.

3. Standby Terminal Current (I_{OS})

The Pin 2 current is measured when Pin 2 is connected to ground.

4. Threshold Voltage (High to Low) (V_{THL})

The Pin 2 voltage is measured at the point which changes the device from operating mode into standby mode.

5. Threshold Voltage (Low to High) (V_{TLH})

The Pin 2 voltage is measured at the point which changes the device from standby mode into operating mode.

6. Voltage Gain (GVA)

The voltage gain equation is as follows:

$$GVA = 20 \log_{10} V2/V1$$

Where $V1$ is the input voltage at TP1 and $V2$ is the measured output voltage at TP2.

$V1$ and $V2$ are measured for the other channels in the same manner.

7. Frequency Response (fr)

The frequency response equation is as follows:

$$fr = 20 \log_{10} V2/V1$$

Where $V1$ is the measured TP2 voltage when the TP1 input frequency is set to 1 MHz and $V2$ is the measured TP2 voltage when the TP1 input frequency is set to 5 MHz. Furthermore, $V1$ is the measured TP2 voltage when the TP1 input frequency is set to 1 MHz and $V2$ is the measured TP2 voltage when the TP1 input frequency is set to 10 MHz.

$V1$ and $V2$ are measured for the other channels in the same manner.

TK15402

MEASUREMENT METHOD

8. Total Harmonic Distortion (THD)

The TP2 signal is measured when a 1 kHz 1 V_{p-p} input signal is applied to TP1. THD is measured for the other channels in the same manner.

9. Maximum Output Voltage (V_{OUT(MAX)})

A 1 kHz input signal is applied to TP1 and the amplitude is slowly increased. The output voltage at TP2 is measured at the point the THD reaches 10%.

V_{OUT(MAX)} is measured for the other channels in the same manner.

10. Cross Talk (CT)

The cross talk equation is as follows:

$$CT = 20 \log_{10} V1/V2$$

Where V1 is measured at output 3 when a 1 MHz 1 V_{p-p} input signal is applied to input 1 or input 2. V2 is measured at output 3 when a 1 MHz 1 V_{p-p} input signal is applied to input 3. Furthermore, V1 is measured at output 2 when a 1 MHz 1 V_{p-p} input signal is applied to input 1 or input 3. V2 is measured at output 2 when a 1 MHz 1 V_{p-p} input signal is applied to input 2. V1 is measured at output 1 when a 1 MHz 1 V_{p-p} input signal is applied to input 2 or input 3. V2 is measured at output 1 when a 1 MHz 1 V_{p-p} input signal is applied to input 1.

11. Signal to Noise Ratio (S/N)

The signal to noise ratio is measured at TP3 when a pedestal input signal is applied to TP1.

12. Differential Gain (DG)

SW1 is closed to change the input bias voltage.

The differential gain is measured at TP3 when a staircase waveform of 10 steps is applied to TP1.

13. Differential Phase (DP)

SW1 is closed to change the input bias voltage.

The differential phase is measured at TP3 when a staircase waveform of 10 steps is applied to TP1.

TYPICAL PERFORMANCE CHARACTERISTICS

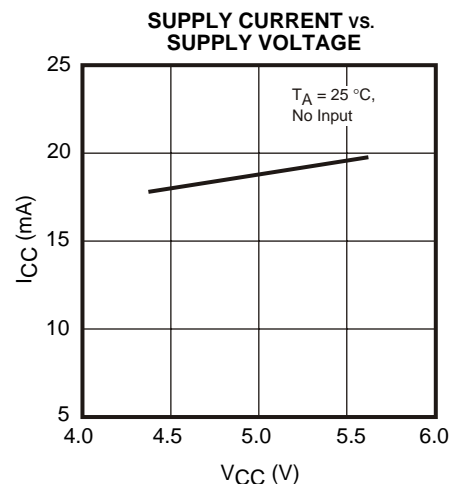
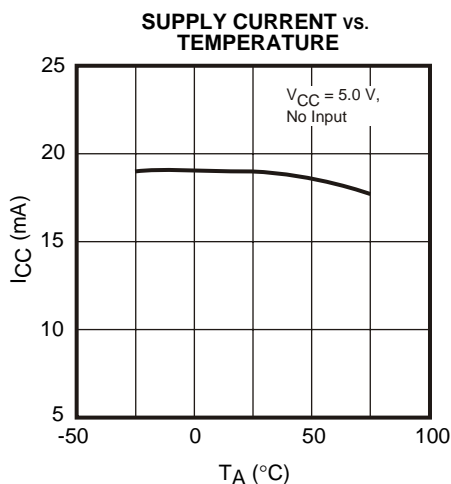

TYPICAL PERFORMANCE CHARACTERISTICS (CONT.)

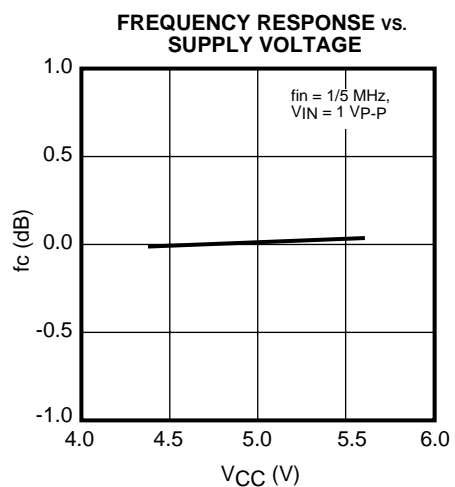
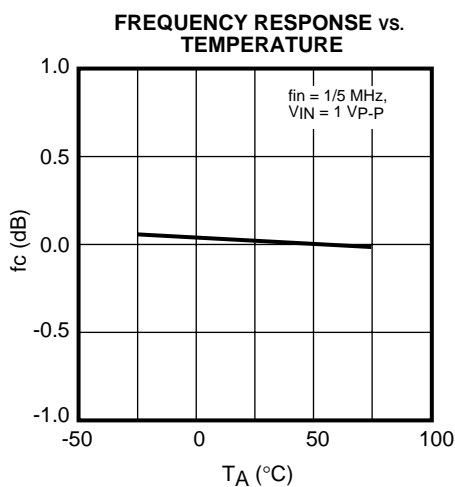
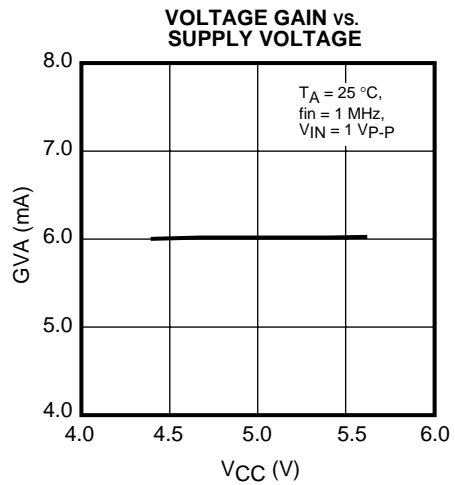
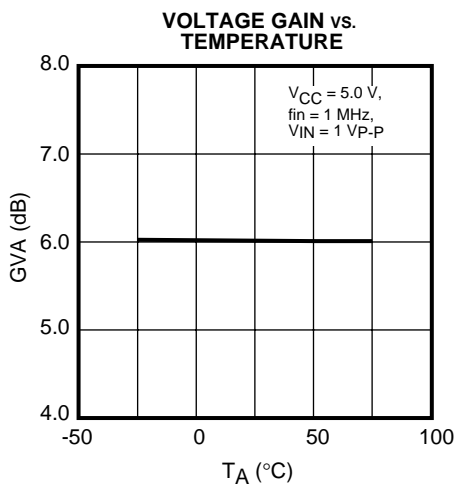
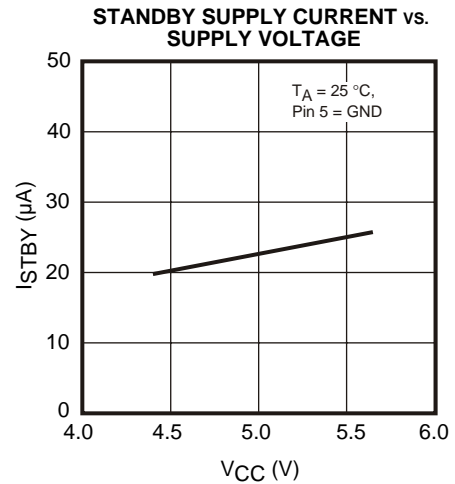
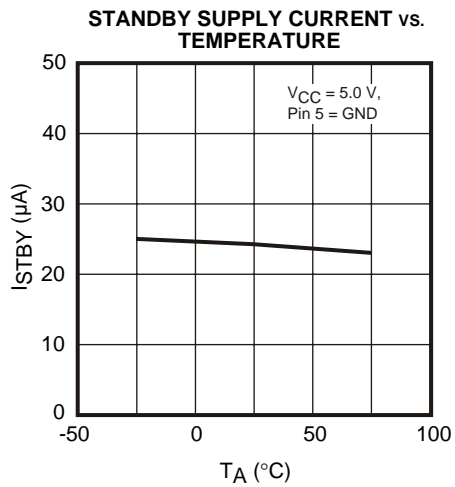

TYPICAL PERFORMANCE CHARACTERISTICS (CONT.)

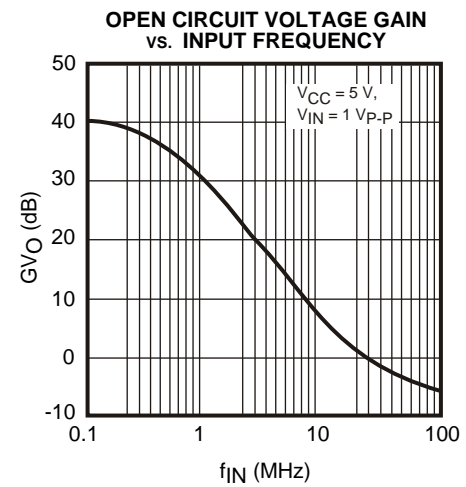
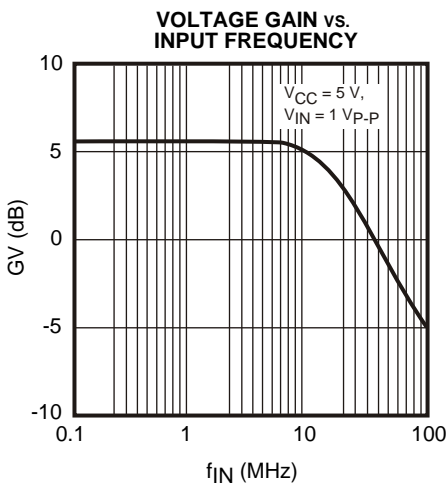
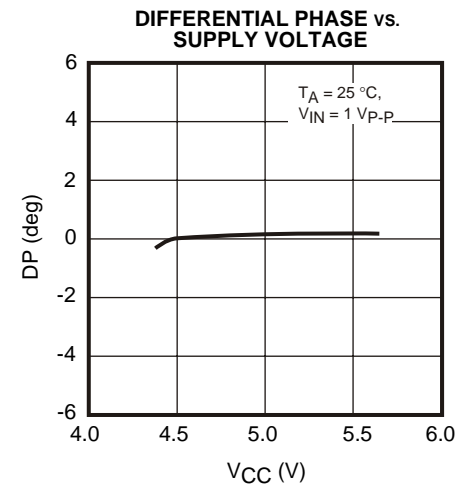
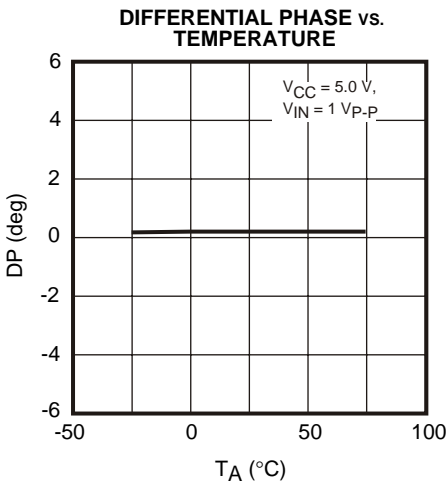
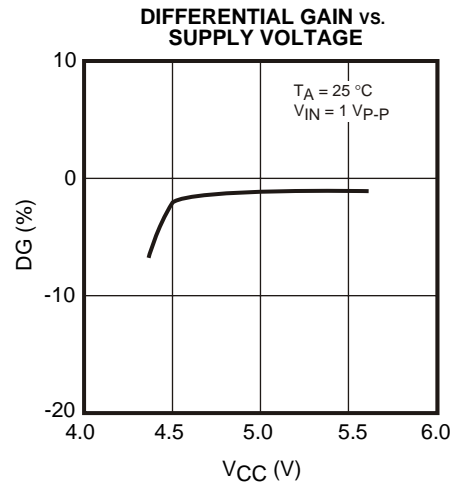
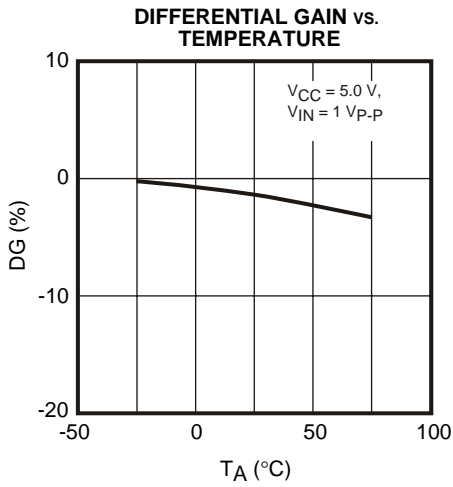

PIN FUNCTION DESCRIPTION

TERMINAL			INTERNAL EQUIVALENT CIRCUIT	DESCRIPTION
PIN NO.	SYMBOL	VOLTAGE		
1	V_{CC}	V_{CC}		Power supply terminal
2	STANDBY	1.4 V		<p>Pin 2 is the standby logic terminal.</p> <p>The device is in the standby state when Pin 2 is pulled down to the low level.</p> <p>The device is in the operation mode when Pin 2 is connected to High or Open.</p>
3 7 12	+INPUT 1 +INPUT 2 +INPUT 3			These pins are non-inverting input terminals.
4 8 11	-INPUT 1 -INPUT 2 -INPUT 3			These pins are inverting input terminals.
5 9 10	OUTPUT 1 OUTPUT 2 OUTPUT 3			<p>These pins are output terminals.</p> <p>These pins are available to drive $75 \Omega + 75 \Omega$ loads.</p>
6	GND	GND		GND terminal

PACKAGE OUTLINE

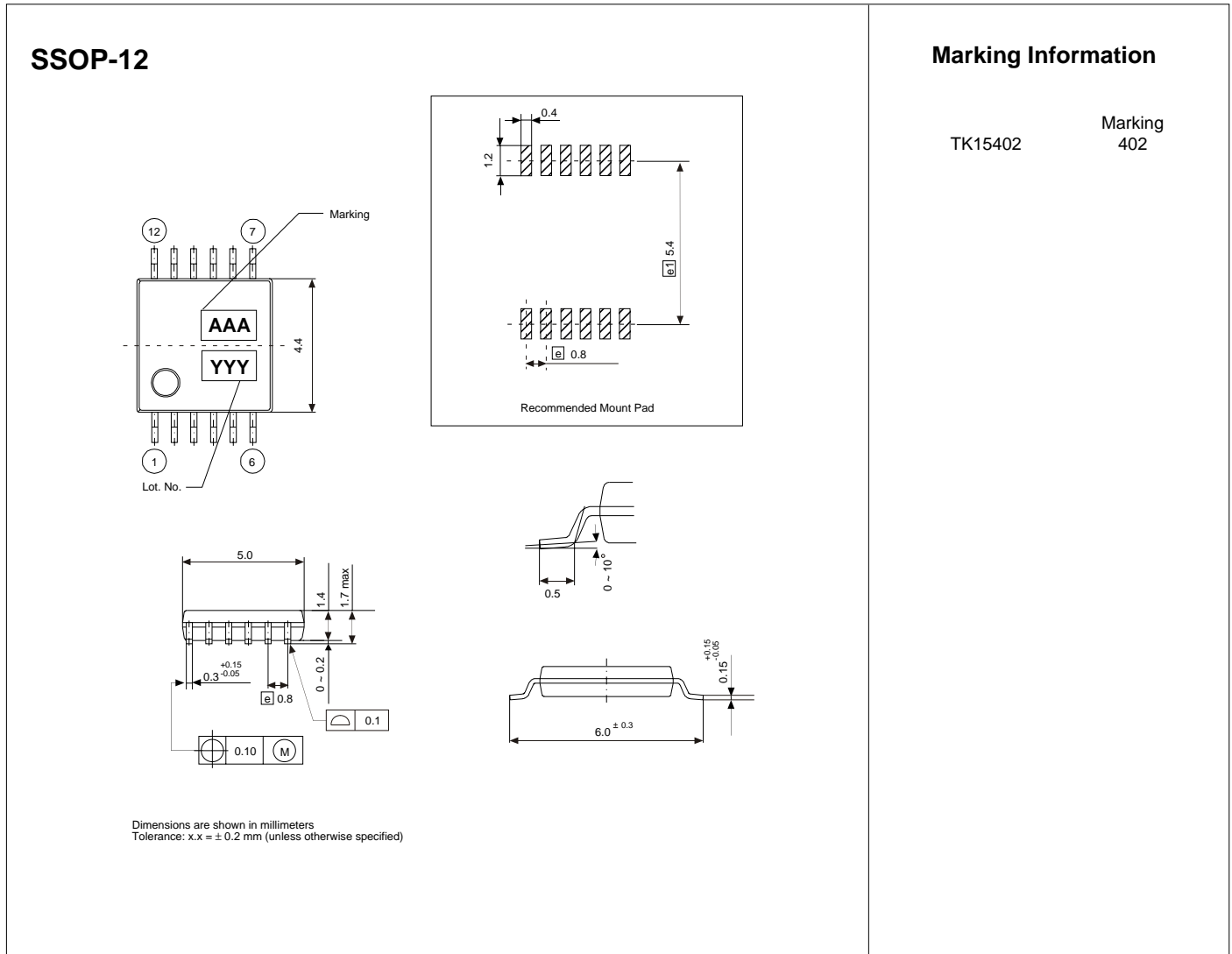

Toko America, Inc. Headquarters
 1250 Feehanville Drive, Mount Prospect, Illinois 60056
 Tel: (847) 297-0070 Fax: (847) 699-7864

TOKO AMERICA REGIONAL OFFICES

Midwest Regional Office
 Toko America, Inc.
 1250 Feehanville Drive
 Mount Prospect, IL 60056
 Tel: (847) 297-0070
 Fax: (847) 699-7864

Western Regional Office
 Toko America, Inc.
 2480 North First Street, Suite 260
 San Jose, CA 95131
 Tel: (408) 432-8281
 Fax: (408) 943-9790

Eastern Regional Office
 Toko America, Inc.
 107 Mill Plain Road
 Danbury, CT 06811
 Tel: (203) 748-6871
 Fax: (203) 797-1223

Semiconductor Technical Support
 Toko Design Center
 4755 Forge Road
 Colorado Springs, CO 80907
 Tel: (719) 528-2200
 Fax: (719) 528-2375

Visit our Internet site at <http://www.tokoam.com>

The information furnished by TOKO, Inc. is believed to be accurate and reliable. However, TOKO reserves the right to make changes or improvements in the design, specification or manufacture of its products without further notice. TOKO does not assume any liability arising from the application or use of any product or circuit described herein, nor for any infringements of patents or other rights of third parties which may result from the use of its products. No license is granted by implication or otherwise under any patent or patent rights of TOKO, Inc.

This datasheet has been download from:

www.datasheetcatalog.com

Datasheets for electronics components.