

TOSHIBA

TL□ 1002(T02)

TOSHIBA LED LAMP

**TLG1002 (T02), TLGD1002 (T02), TLPG1002 (T02), TLO1002 (T02)
TLY1002 (T02), TLS1002 (T02), TLUR1002 (T02), TLR1002 (T02)**

PANEL CIRCUIT INDICATOR

Unit in mm

- Surface Mount Device
- 2.0 (L) × 1.25 (W) × 1.1 (H) mm Size
Small Package - High Density Mounting is Available
- Colors : Red, Orange, Yellow, Green, Pure Green
- Available of Automounting Machine Use
- Reflow Soldering is possible
- Standard Embossed Taping
4 mm Pitch : T02 (3000 pcs/ Reel)
- Application : Telephone Cordless/ Cellular
Portable Instrument, Backlight, etc.

LINE-UP

PRODUCT NAME	COLOR	MATERIAL
TLR1002	Red	GaP
TLUR1002	Red	GaAlAs
TLS1002	Red	GaAsP
TLO1002	Orange	GaAsP
TLY1002	Yellow	GaAsP
TLGD1002	Green	GaP
TLG1002	Green	GaP
TLPG1002	Pure Green	GaP

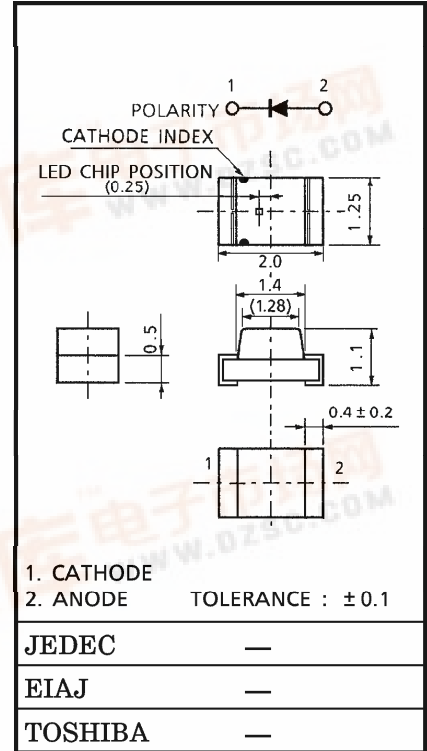

Weight : 2 mg

MAXIMUM RATINGS (Ta = 25°C)

PRODUCT NAME	FORWARD CURRENT (DC) I _F (mA)	REVERSE VOLTAGE V _R (V)	POWER DISSIPATION P _D (mW)	OPERATING TEMPERATURE T _{opr} (°C)	STORAGE TEMPERATURE T _{stg} (°C)
TLR1002	25	4	70	-25~80	-30~85
TLUR1002	25	4	55		
TLS1002	25	4	65		
TLO1002	25	4	65		
TLY1002	25	4	65		
TLGD1002	25	4	62.5		
TLG1002	25	4	62.5		
TLPG1002	25	4	65		

ELECTRICAL CHARACTERISTICS (Ta = 25°C)

PRODUCT NAME	FORWARD VOLTAGE V _F				REVERSE CURRENT I _R	
	MIN	TYP.	MAX	I _F	MAX	V _R
TLR1002	—	2.05	2.55	10	5	4
TLUR1002	—	1.75	2.2	20	50	4
TLS1002	—	2.05	2.6	20	50	4
TLO1002	—	2.05	2.6	20	50	4
TLY1002	—	2.05	2.6	20	50	4
TLGD1002	—	2.1	2.5	20	5	4
TLG1002	—	2.15	2.5	20	5	4
TLPG1002	—	2.15	2.6	20	5	4
Unit	V			mA	μA	V

OPTICAL CHARACTERISTICS (Ta = 25°C)

PRODUCT NAME	LUMINOUS INTENSITY I _v				PEAK EMISSION WAVELENGTH λ _p				
	MIN	TYP.	MAX	I _F	MIN	TYP.	MAX	Δλ TYP.	I _F
TLR1002	0.15	0.8	—	10	—	700	—	100	10
TLUR1002	1.53	6	—	20	—	660	—	25	20
TLS1002	1.53	5	—	20	—	635	—	40	20
TLO1002	2.72	9	—	20	—	610	—	35	20
TLY1002	2.72	9	—	20	—	585	—	32	20
TLGD1002	4.76	15	—	20	—	570	—	25	20
TLG1002	2.72	9	—	20	—	567	—	25	20
TLPG1002	0.85	2	—	20	—	555	—	20	20
Unit	mcd			mA	nm			nm	mA

TLR1002

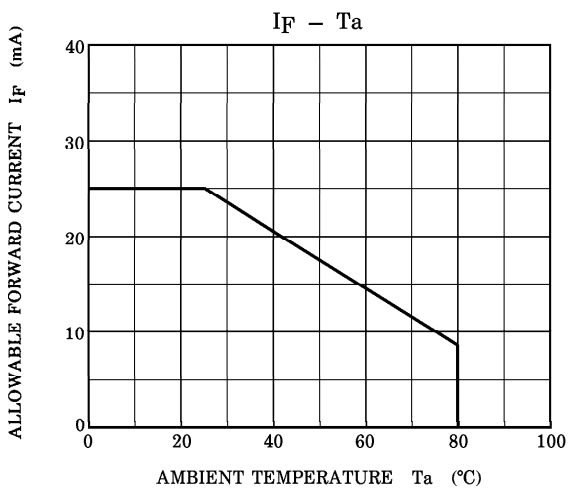
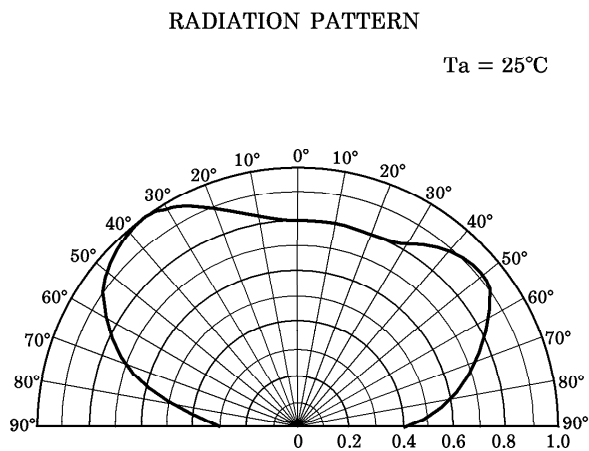
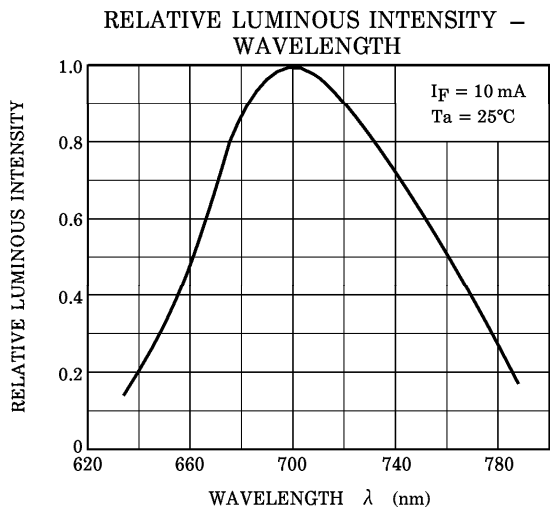
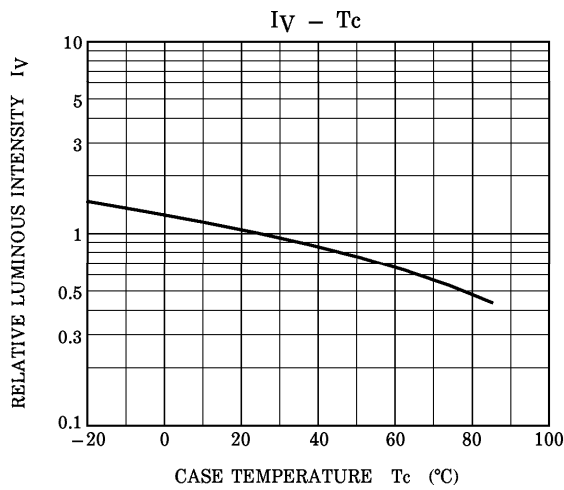
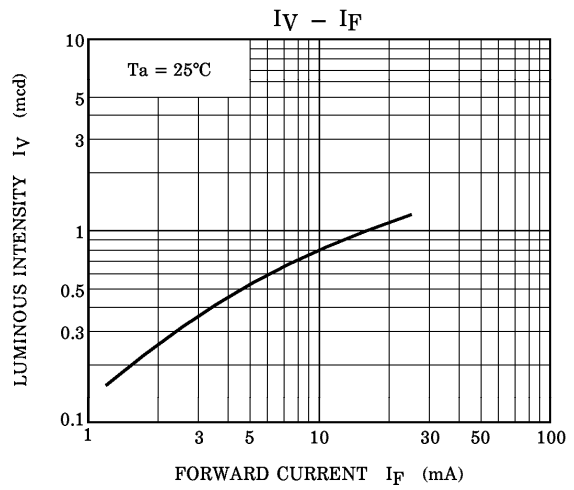
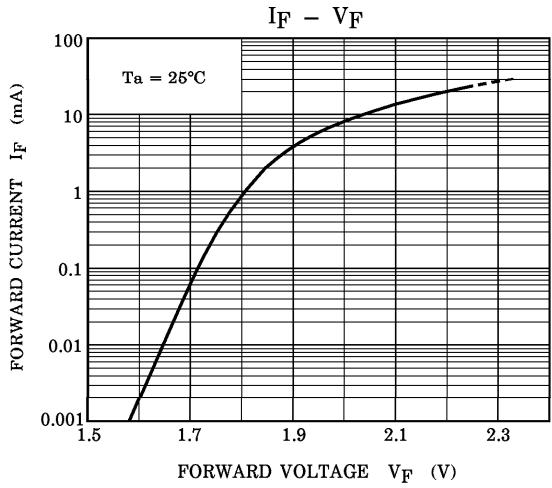

TLUR1002

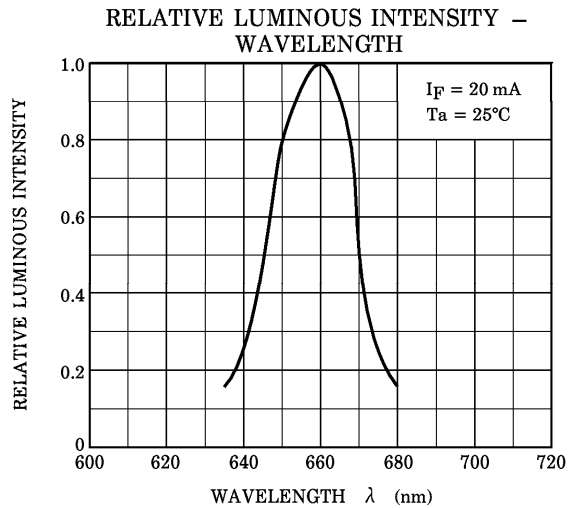
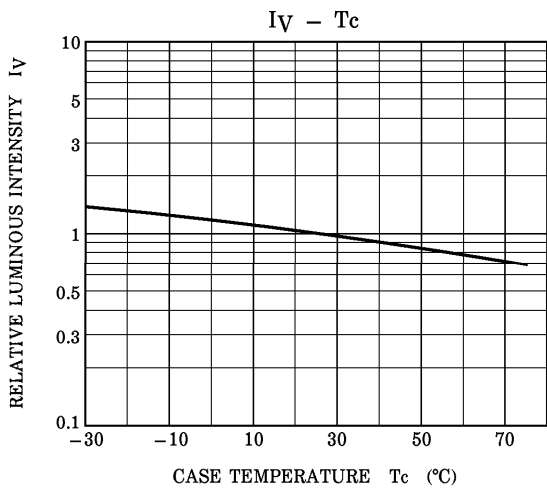
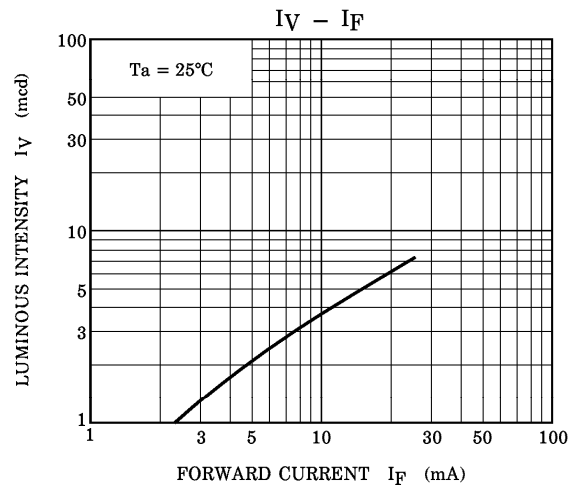
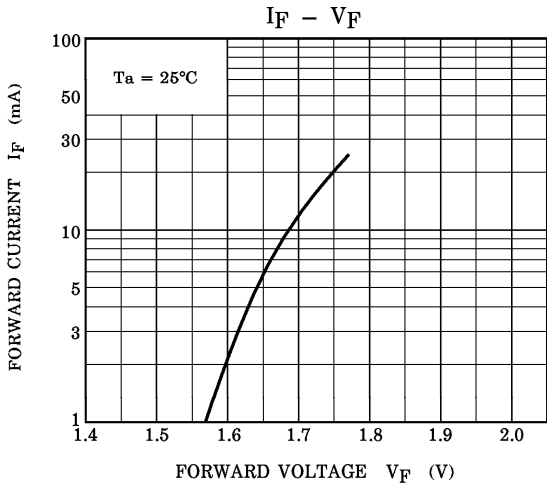

RADIATION PATTERN

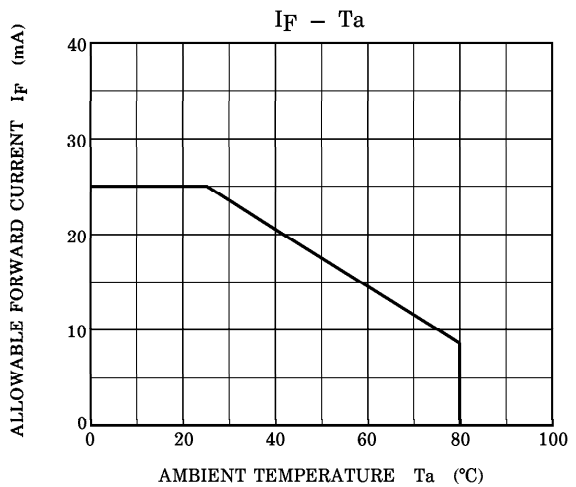
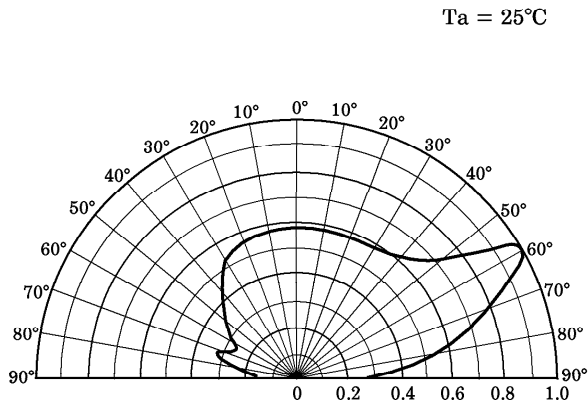

TLS1002

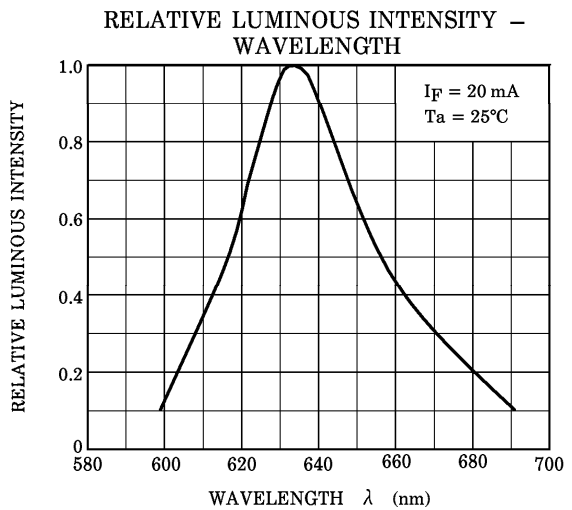
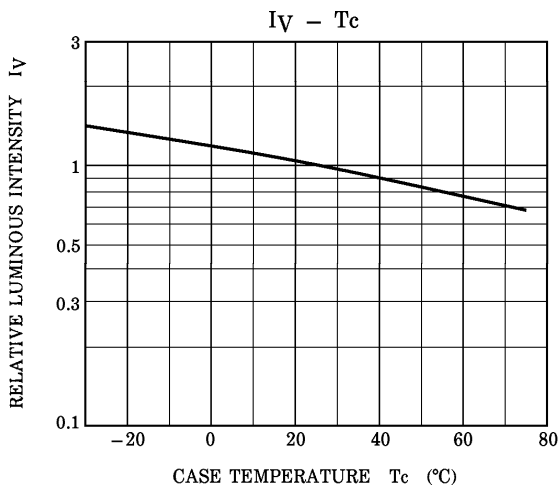
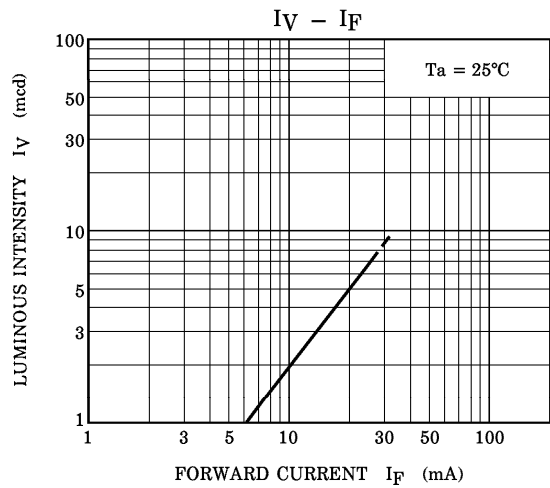
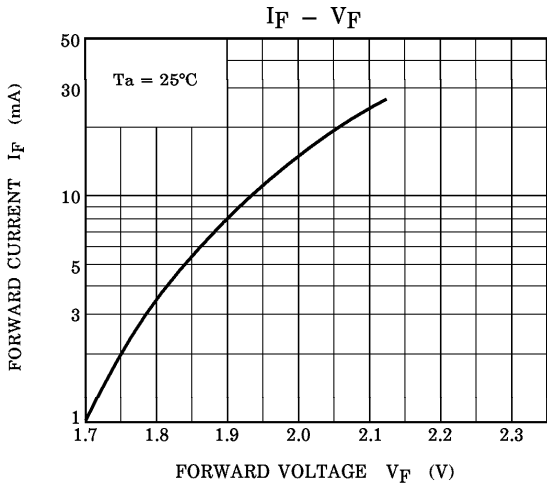

RADIATION PATTERN

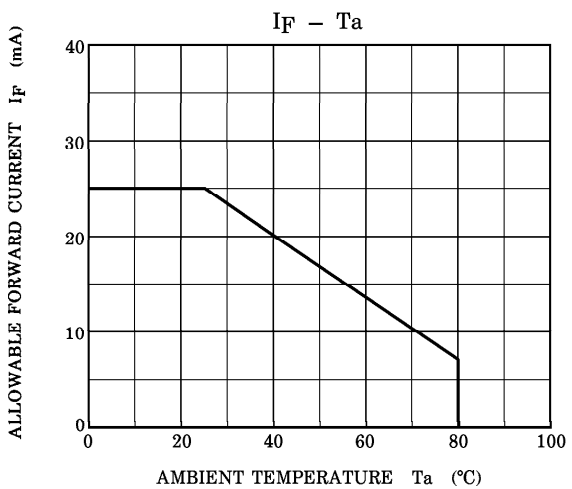
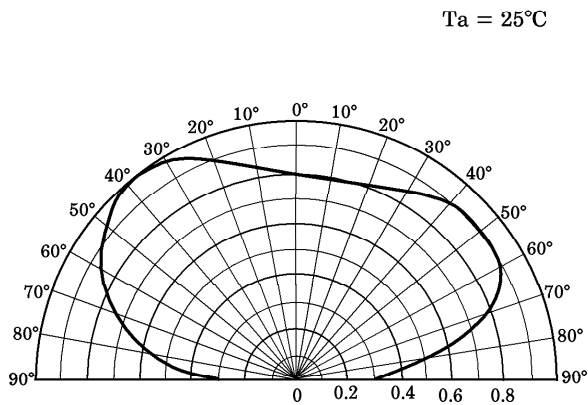

TLO1002

$I_F - V_F$

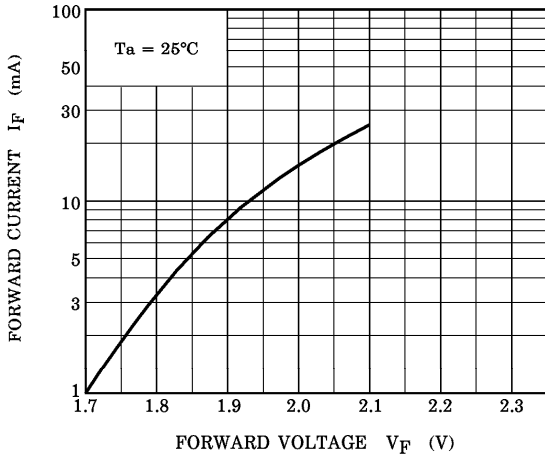

$I_V - I_F$

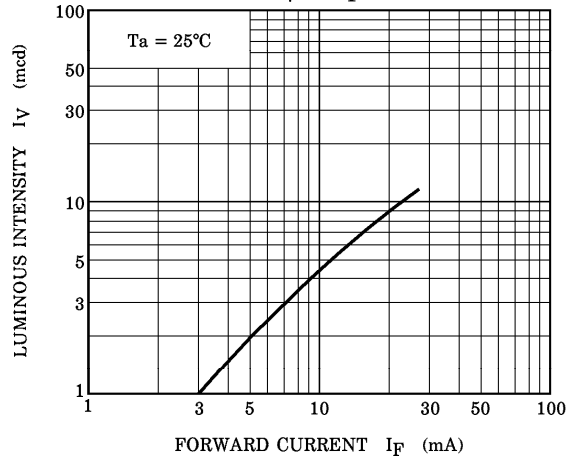

$I_V - T_c$

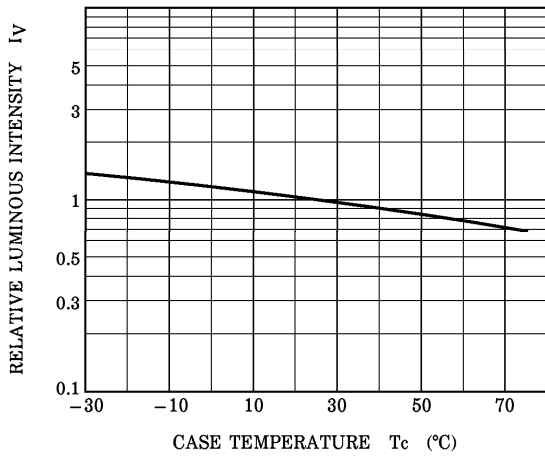

RELATIVE LUMINOUS INTENSITY - WAVELENGTH

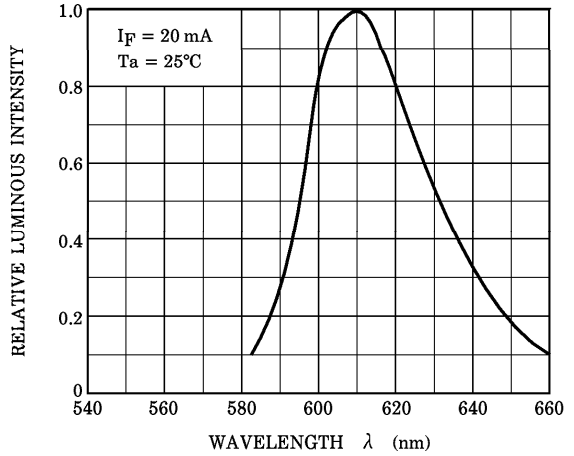

RADIATION PATTERN

$T_a = 25^\circ\text{C}$

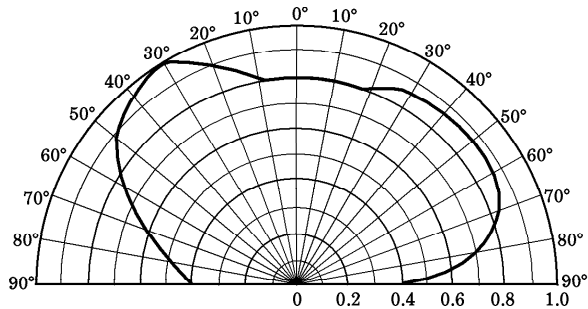

$I_F - T_a$

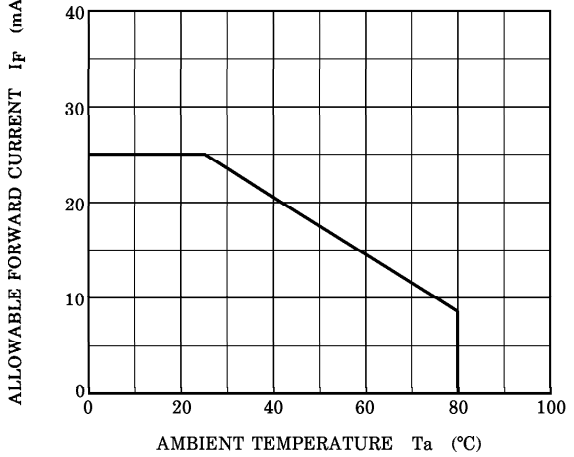

TLY1002

$I_F - V_F$

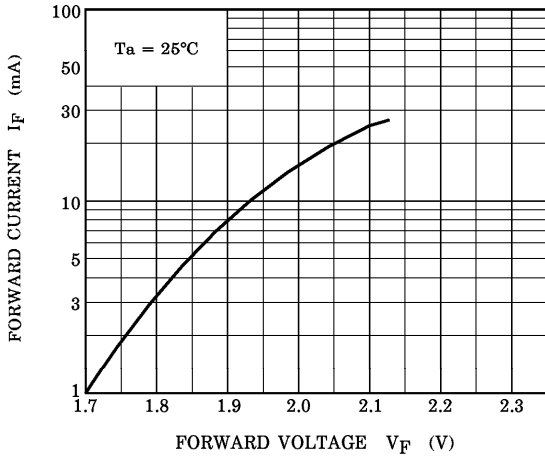

$I_V - I_F$

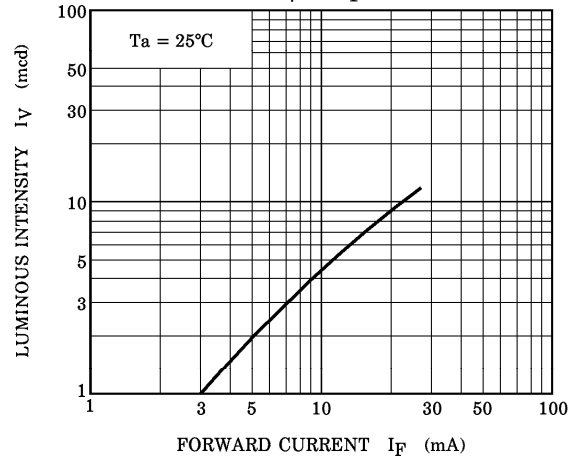

$I_V - T_c$

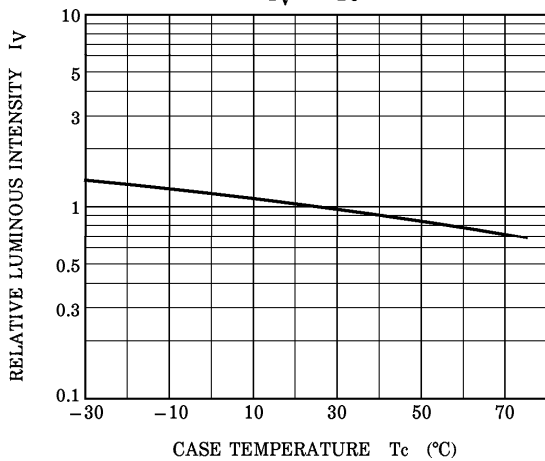

RELATIVE LUMINOUS INTENSITY - WAVELENGTH

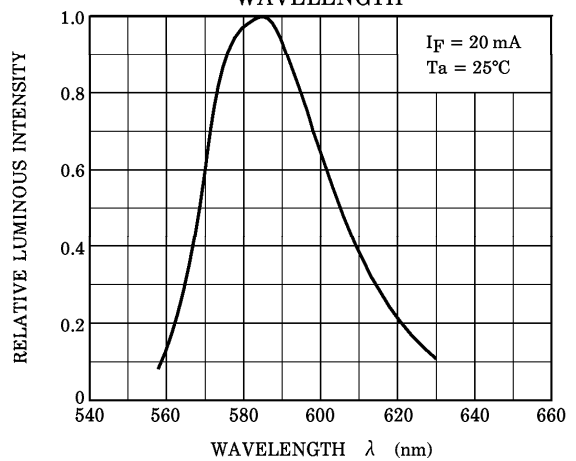

RADIATION PATTERN

$T_a = 25^\circ\text{C}$

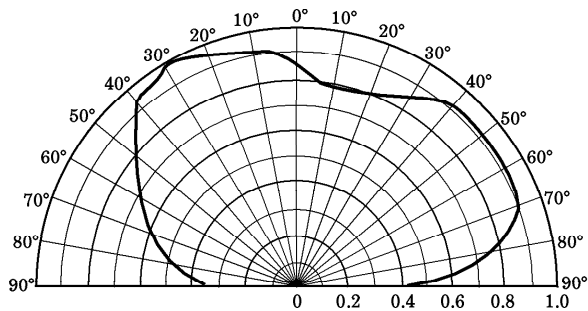

$I_F - T_a$

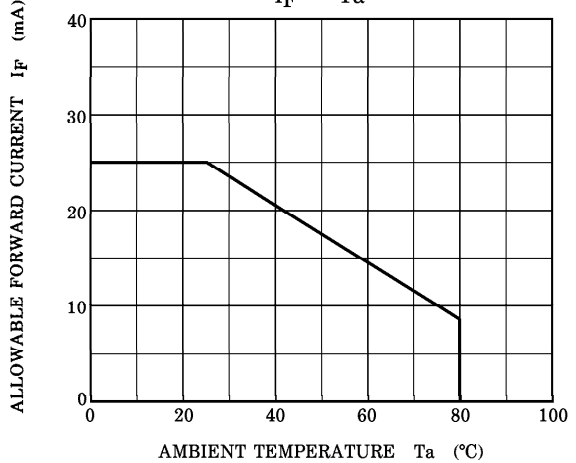

TLGD1002

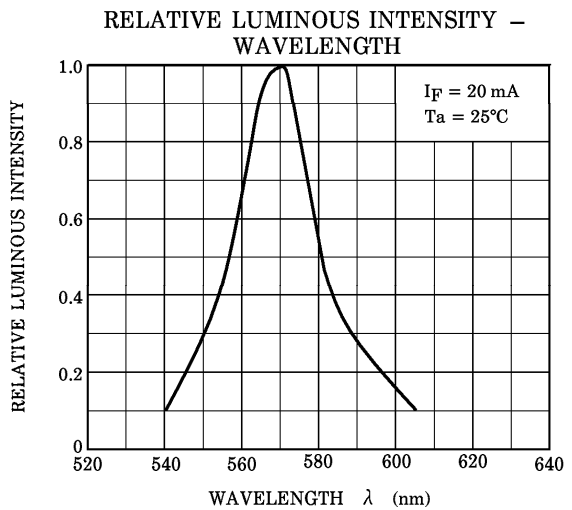
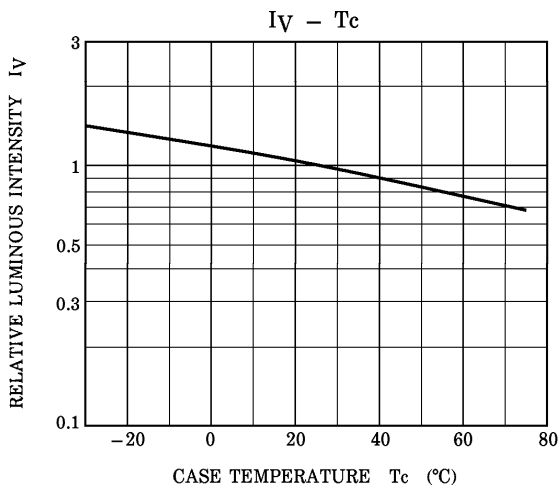
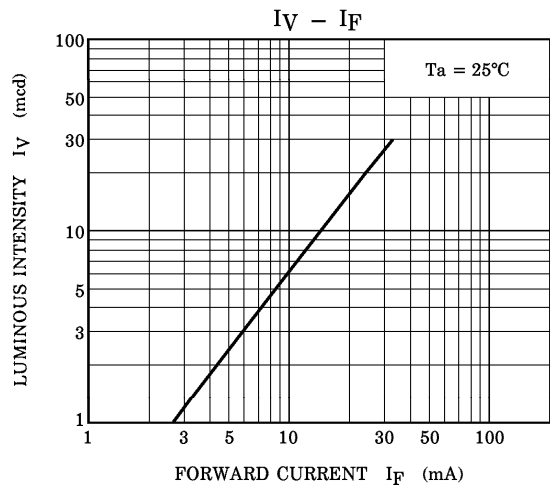
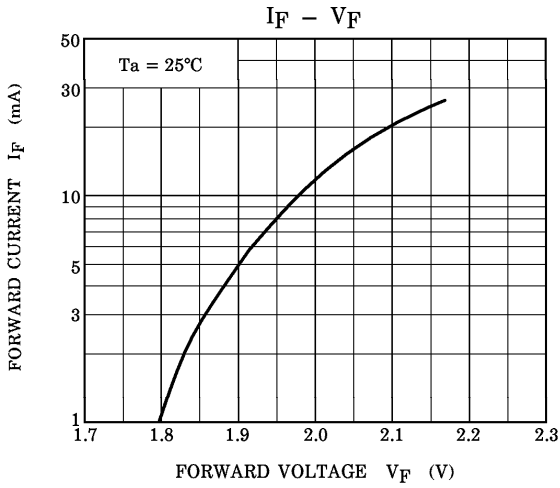

RADIATION PATTERN

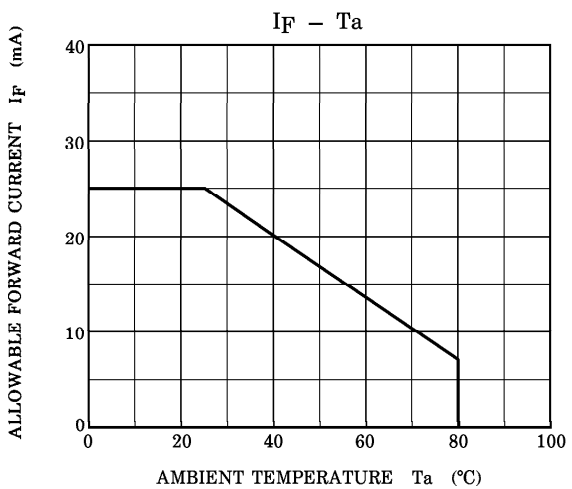
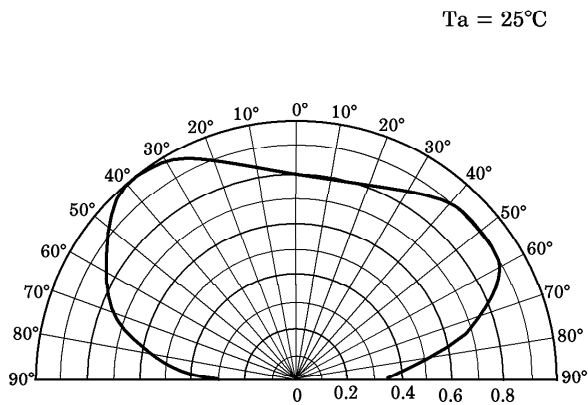

TLG1002

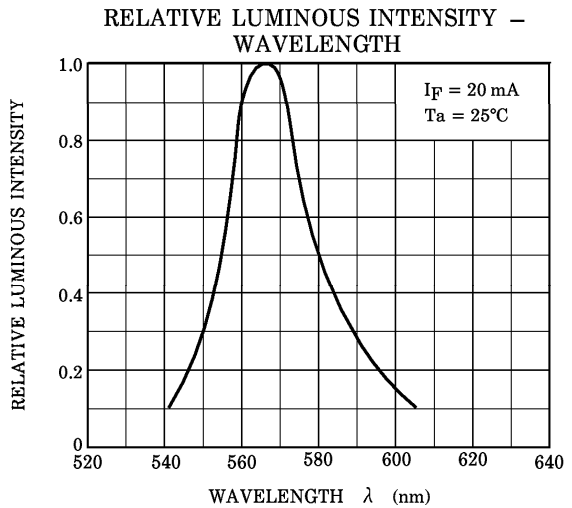
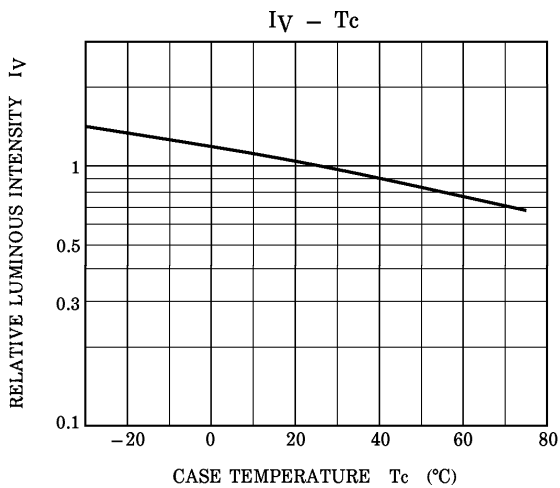
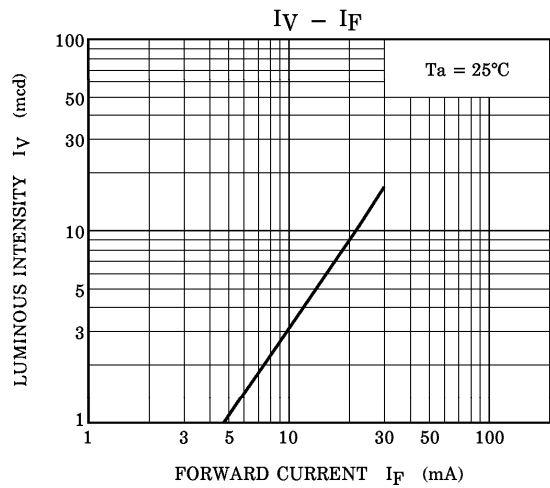
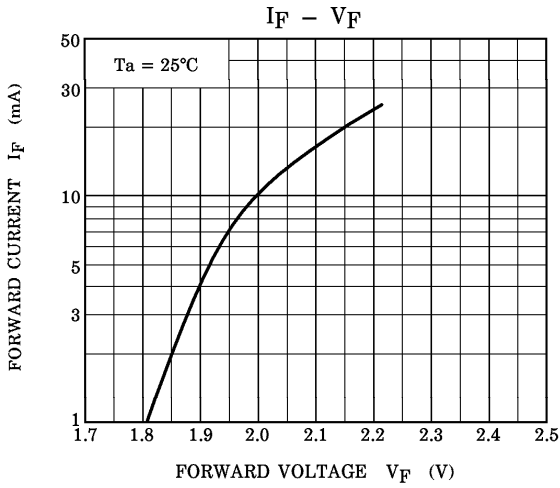

RADIATION PATTERN

$T_a = 25^\circ\text{C}$

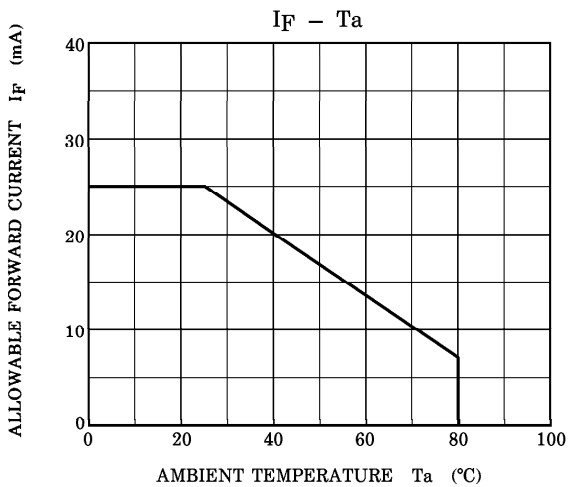
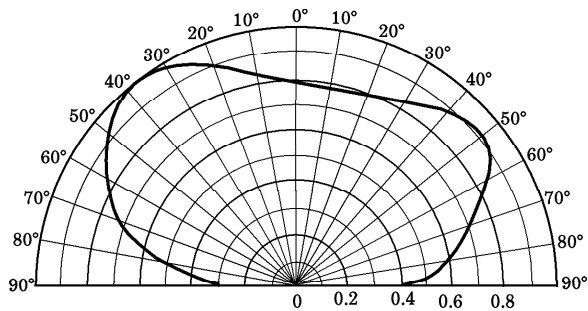

TLPG1002

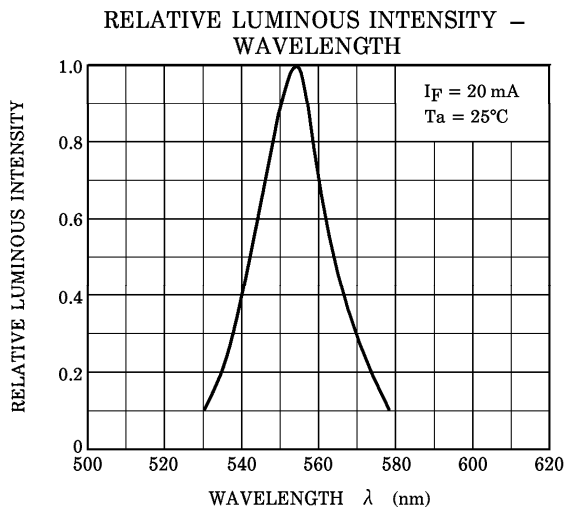
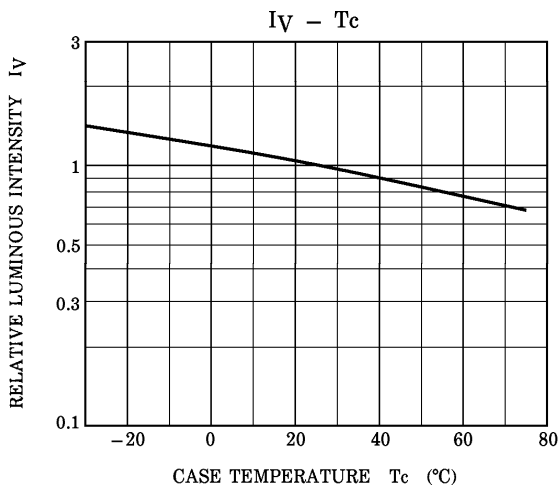
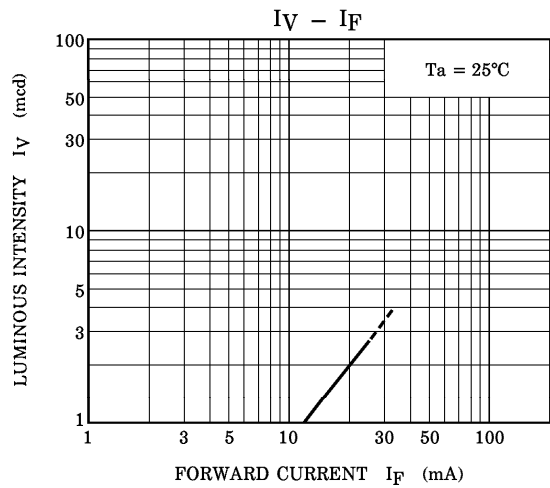
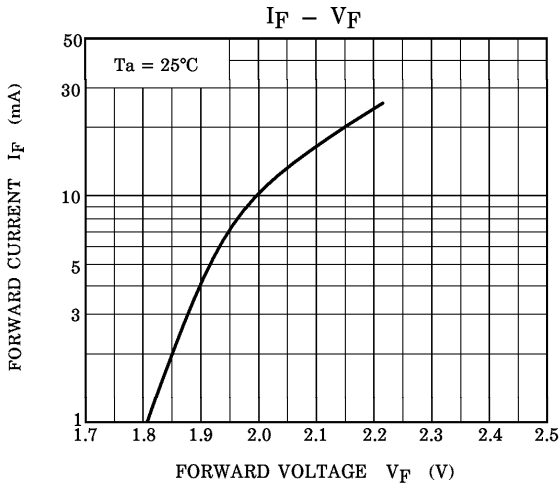

RADIATION PATTERN

$T_a = 25^\circ\text{C}$

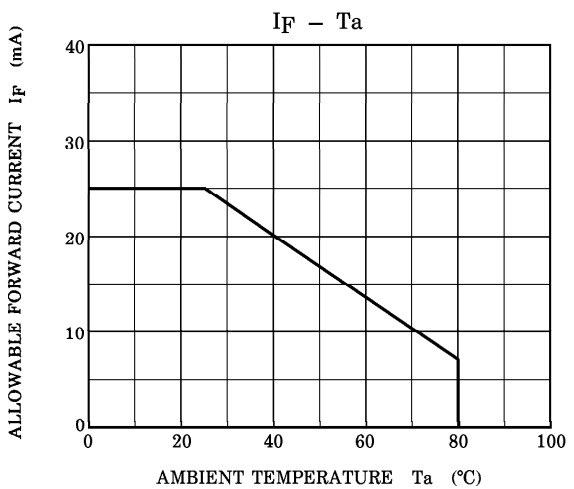
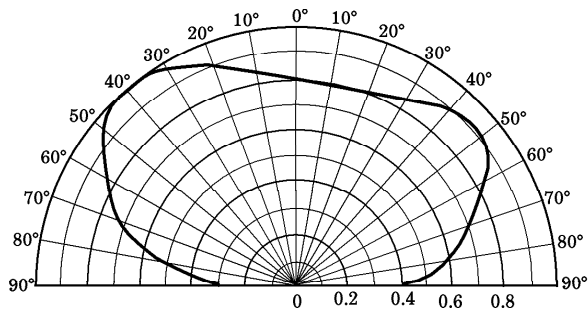

PACKAGING

These LED devices are packed in an aluminum envelope with silica gel to avoid moisture absorption. The optical characteristics may be affected by exposure to moisture in the air prior to soldering and it should be stored under the following conditions.

- Temperature : 5~30°C
- Relative Humidity : 60% or lower

Baking is required if the device have been stored unopened for more than 6 months or if the aluminum envelope has been opened for more than 168 h.

Recommended baking condition is 60°C for 12 h minimum in the dry atmosphere.

PRECAUTION FOR MOUNTING

- Do not apply force to the plastic part of the LED in high temperature conditions.
- Do not apply friction using a hard materials for avoid injuring the plastic part of the LED.
- Keep the LED away from any other parts when assembling boards into the set.

SOLDERING

- Reflow soldering

Temperature profile

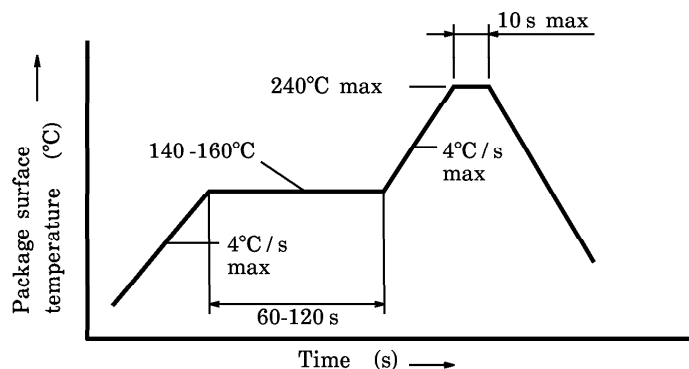

- Second time reflow soldering

In case of second reflow soldering, it should be performed within 168 h after first reflow under the above conditions.

Storage conditions before second reflow soldering : 30°C, 60% RH or lower

- Do not perform flow soldering.
- Make any necessary soldering corrections manually.
(Do not do this more than once for any given pin.)

- Soldering iron : Less than 25 W
- Temperature : Lower than 300°C
- Time : Within 3 s

- Recommended soldering pattern

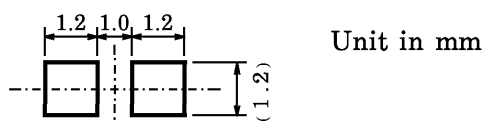

3. Tape Dimensions

(Unit : mm)

SYMBOL	DIMENSION	TOLERANCE	SYMBOL	DIMENSION	TOLERANCE
D	1.50	+0.1 / -0	P ₂	2.00	±0.05
E	1.75	±0.1	W	8.00	±0.3
P ₀	4.00	±0.1	P	4.00	±0.1
t	0.25	±0.05	A ₀	1.45	±0.1
F	3.50	±0.05	B ₀	2.25	±0.1
D ₁	1.10	±0.1	K ₀	1.30	±0.05

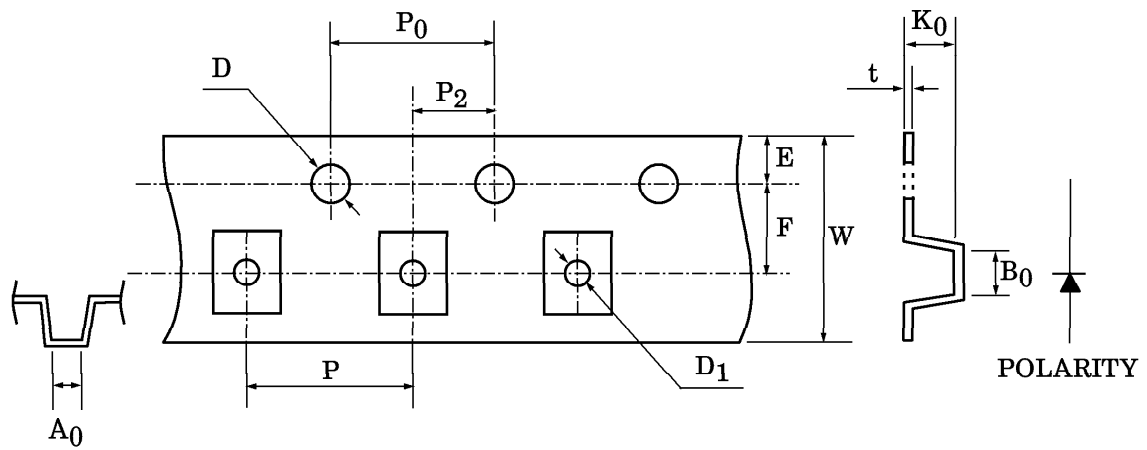

4. Dimensions of reel

Unit in mm

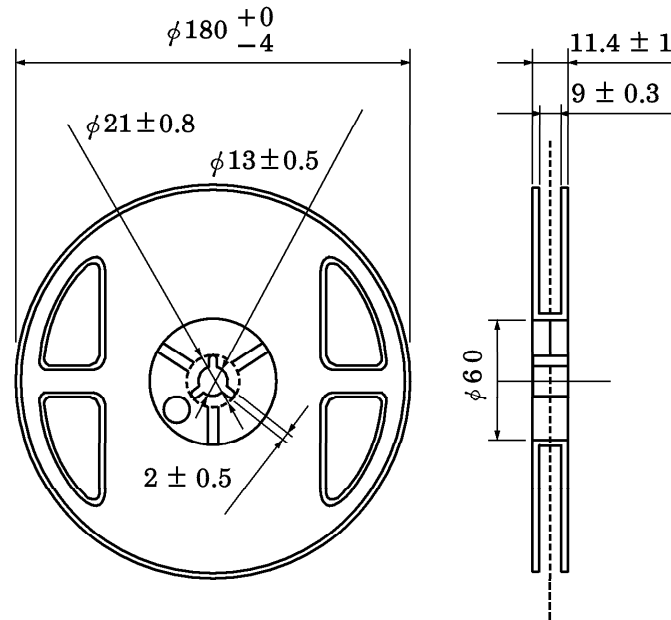

5. Leading part

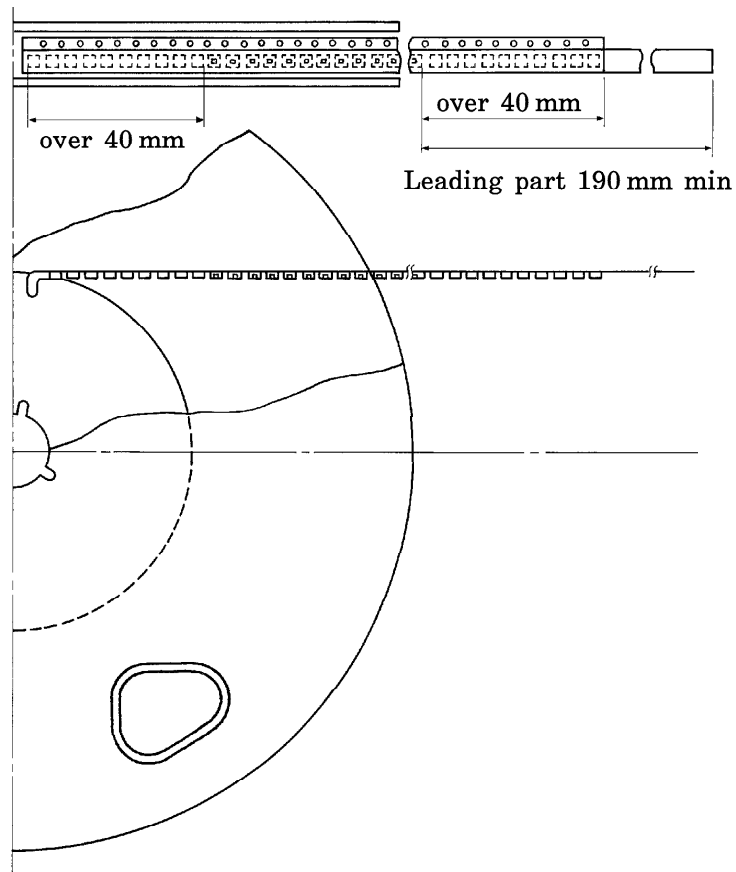

6. Packing Form

(1) Number of Devices per Reel and Carton

Reel	3000 devices
Carton	15000 devices

(2) Packing : Silica gel and reel are packed into sealed aluminum pack.

7. Notation Method

(1) Example : TLG1002 (T02)

P/N :

TYPE	TLG1002		
ADD. C	(T02)	Q'TY	3000 pcs
NOTE	(rank symbol)		Lot Number

(2) Label location :

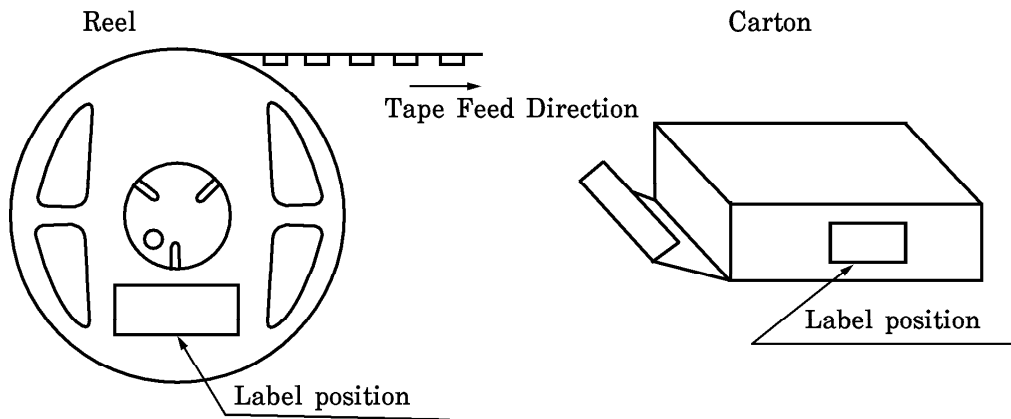

Aluminum pack : Attached to center of one side

RESTRICTIONS ON PRODUCT USE

000707EAC

- TOSHIBA is continually working to improve the quality and reliability of its products. Nevertheless, semiconductor devices in general can malfunction or fail due to their inherent electrical sensitivity and vulnerability to physical stress. It is the responsibility of the buyer, when utilizing TOSHIBA products, to comply with the standards of safety in making a safe design for the entire system, and to avoid situations in which a malfunction or failure of such TOSHIBA products could cause loss of human life, bodily injury or damage to property. In developing your designs, please ensure that TOSHIBA products are used within specified operating ranges as set forth in the most recent TOSHIBA products specifications. Also, please keep in mind the precautions and conditions set forth in the "Handling Guide for Semiconductor Devices," or "TOSHIBA Semiconductor Reliability Handbook" etc..
- The TOSHIBA products listed in this document are intended for usage in general electronics applications (computer, personal equipment, office equipment, measuring equipment, industrial robotics, domestic appliances, etc.). These TOSHIBA products are neither intended nor warranted for usage in equipment that requires extraordinarily high quality and/or reliability or a malfunction or failure of which may cause loss of human life or bodily injury ("Unintended Usage"). Unintended Usage include atomic energy control instruments, airplane or spaceship instruments, transportation instruments, traffic signal instruments, combustion control instruments, medical instruments, all types of safety devices, etc.. Unintended Usage of TOSHIBA products listed in this document shall be made at the customer's own risk.
- Gallium arsenide (GaAs) is a substance used in the products described in this document. GaAs dust and fumes are toxic. Do not break, cut or pulverize the product, or use chemicals to dissolve them. When disposing of the products, follow the appropriate regulations. Do not dispose of the products with other industrial waste or with domestic garbage.
- The information contained herein is presented only as a guide for the applications of our products. No responsibility is assumed by TOSHIBA CORPORATION for any infringements of intellectual property or other rights of the third parties which may result from its use. No license is granted by implication or otherwise under any intellectual property or other rights of TOSHIBA CORPORATION or others.
- The information contained herein is subject to change without notice.