

Preliminary Specification

TMF3201J

Dual N-Channel Dual-Gate MOSFET

Description

The TMF3201J is an N-channel enhancement type, dual-insulated gate, field-effect transistor that utilizes MOS construction. It consists of two equal dual gate MOSFET amplifiers with shared source and gate2 leads. The source and substrate are interconnected. Internal bias circuits enable DC stabilization and a very good cross-modulation performance during AGC. Integrated diodes between the gates and source protect against excessive input voltage surges. The transistor has a SOT363 micro-miniature plastic package.

Features

- Two AGC amplifiers in a single package
- Integrated gate protection diodes
- High AGC-range, high gain, low noise figure

Applications

- Two gain controlled input stage for UHF and VHF tuners
- Professional communications equipment

Absolute Maximum Ratings (T_a = 25 °C)

Parameter	Symbol	Ratings	Unit
Per MOSFET ; unless otherwise specified			
Drain-Source Voltage	V _{DS}	10	V
Drain Current	I _D	30	mA
Gate 1 Current	I _{G1}	±10	mA
Total Power Dissipation	P _{tot}	200	mW
Storage Temperature	T _{stg}	-65 ~ 150	°C
Operating Junction Temperature	T _j	150	°C

Caution : Electro Static Discharge sensitive device, observe handling precaution

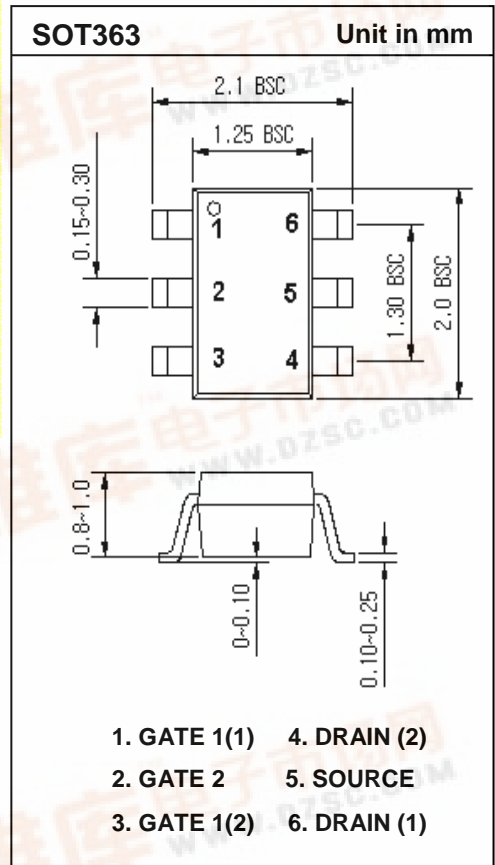

DC Characteristics

($T_j = 25\text{ }^\circ\text{C}$, per MOSFET, unless otherwise specified)

PARAMETER	SYMBOL	CONDITION	MIN.	MAX.	UNIT
Drain-source breakdown voltage	$V_{(BR)DSS}$	$V_{G1-S}=V_{G2-S}=0; I_D=10\mu A$	10	-	V
Gate1-source breakdown voltage	$V_{(BR)G1-SS}$	$V_{G2-S}=V_{DS}=0; I_{G1-S}=10mA$	6	10	V
Gate2-source breakdown voltage	$V_{(BR)G2-SS}$	$V_{G1-S}=V_{DS}=0; I_{G2-S}=10mA$	6	10	V
Forward source-gate1 voltage	$V_{(F)S-G1}$	$V_{G2-S}=V_{DS}=0; I_{S-G1}=10mA$	0.5	1.5	V
Forward source-gate2 voltage	$V_{(F)S-G2}$	$V_{G1-S}=V_{DS}=0; I_{S-G2}=10mA$	0.5	1.5	V
Gate1-source threshold voltage	$V_{G1-S(th)}$	$V_{DS}=5V; V_{G2-S}=4V; I_D=100\mu A$	0.3	1.0	V
Gate2-source threshold voltage	$V_{G2-S(th)}$	$V_{DS}=5V; V_{G1-S}=4V; I_D=100\mu A$	0.3	1.2	V
Drain-source current	I_{DSX}	$V_{G2-S}=4V; V_{DS}=5V; R_G=62k\Omega$	8	16	mA
Gate1 cut-off current	I_{G1-S}	$V_{G1-S}=5V; V_{G2-S}=V_{DS}=0$	-	50	nA
Gate2 cut-off current	I_{G2-S}	$V_{G2-S}=5V; V_{G1-S}=V_{DS}=0$	-	20	nA

AC Characteristics

(Common source; $T_a = 25\text{ }^\circ\text{C}$, $V_{G2-S} = 4V$, $V_{DS} = 5V$, $I_D = 12mA$; per MOSFET ;unless otherwise specified)

PARAMETER	SYMBOL	CONDITIONS	MIN.	TYP.	MAX.	UNIT
Forward transfer admittance	$ y_{FS} $	$T_j=25\text{ }^\circ\text{C}$	25	30	40	mS
Input capacitance at gate1	C_{ig1-ss}	$f=1MHz$	-	1.9	2.5	pF
Input capacitance at gate2	C_{ig2-ss}	$f=1MHz$	-	3.3	-	pF
Output capacitance	C_{oss}	$f=1MHz$	-	1.4	-	pF
Reverse transfer capacitance	C_{rss}	$f=1MHz$	-	20	-	fF
Power gain	Gtr	$f=200MHz; Z_i = S_{11}^*, Z_o = S_{22}^*$	30	31	-	dB
		$f=400MHz; Z_i = S_{11}^*, Z_o = S_{22}^*$	26	28	-	dB
		$f=800MHz; Z_i = S_{11}^*, Z_o = S_{22}^*$	21	25	-	dB
Noise figure	NF	$f=400MHz; Z_i = S_{11\text{ opt}}(NF)$	-	1.5	-	dB
		$f=800MHz; Z_i = S_{11\text{ opt}}(NF)$	-	1.7	2.5	dB
Cross-modulation	X_{mod}	$k=1\%, fw=50MHz; funw=60MHz$ AGC = 0dB	90	-	-	dB μV
		$k=1\%, fw=50MHz; funw=60MHz$ AGC = 10dB	-	92	-	dB μV
		$k=1\%, fw=50MHz; funw=60MHz$ AGC = 40dB	100	105	-	dB μV

□ Equivalent circuit (Top view)

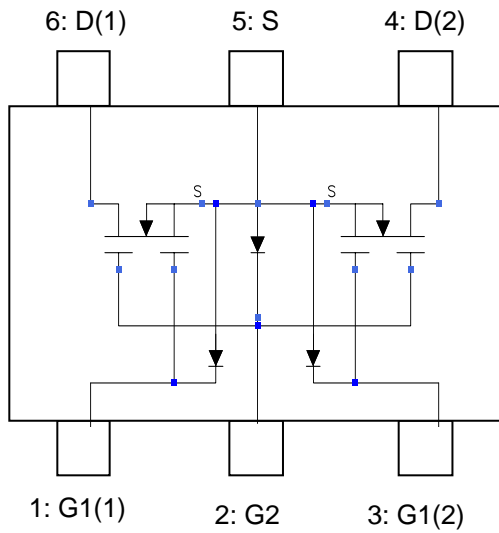

□ Making

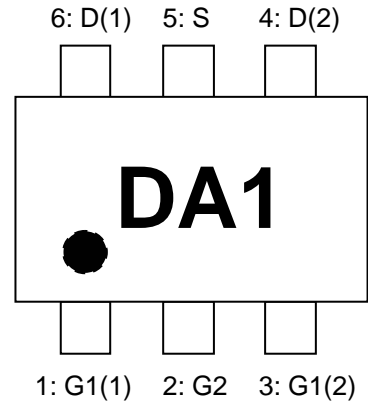

□ Pin Configuration

PIN NO	SYMBOL	DESCRIPTION
1	G1(1)	Gate1_Amp1
2	G2	Gate2
3	G1(2)	Gate1_Amp2
4	D(2)	Drain_Amp2
5	S	Source
6	D(1)	Drain_Amp1

□ Test circuit

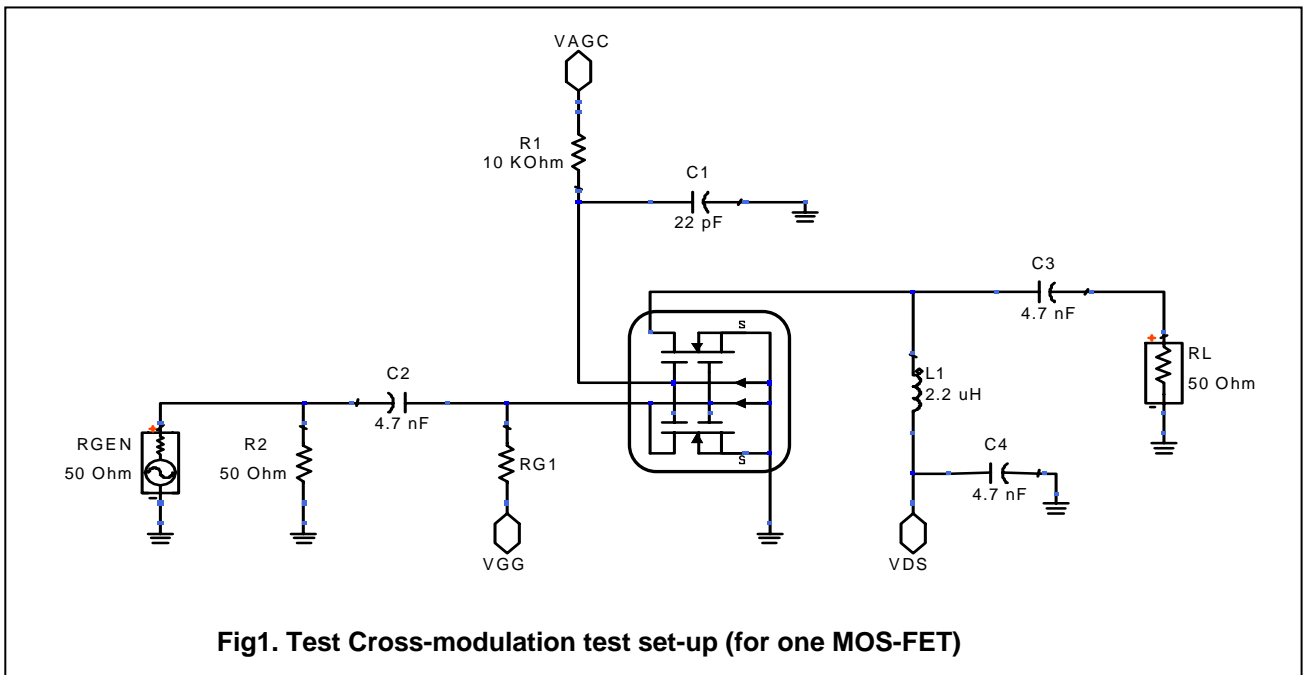
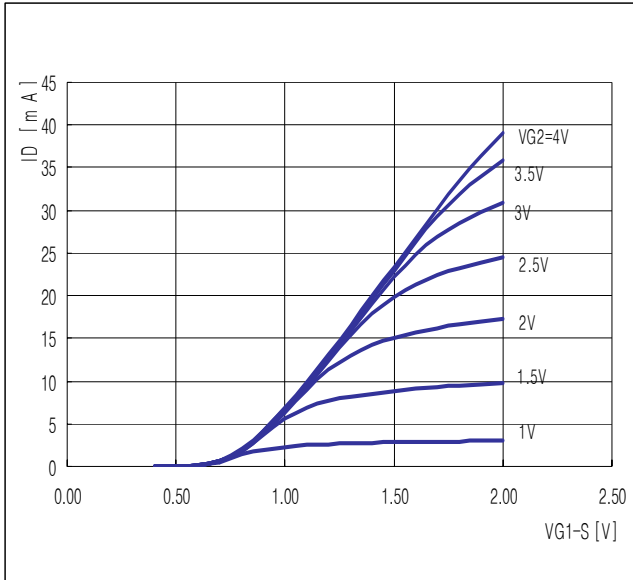

Fig1. Test Cross-modulation test set-up (for one MOS-FET)

□ Graphs For One MOSFET



$V_{DS} = 5V, T_j = 25^\circ C$

Fig.2 Transfer characteristics

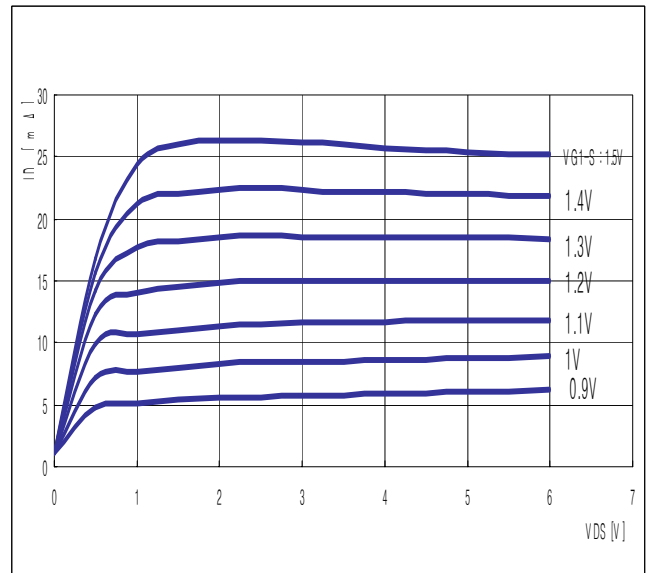

$V_{G2-S} = 4V, T_j = 25^\circ C$

Fig3. Output characteristics

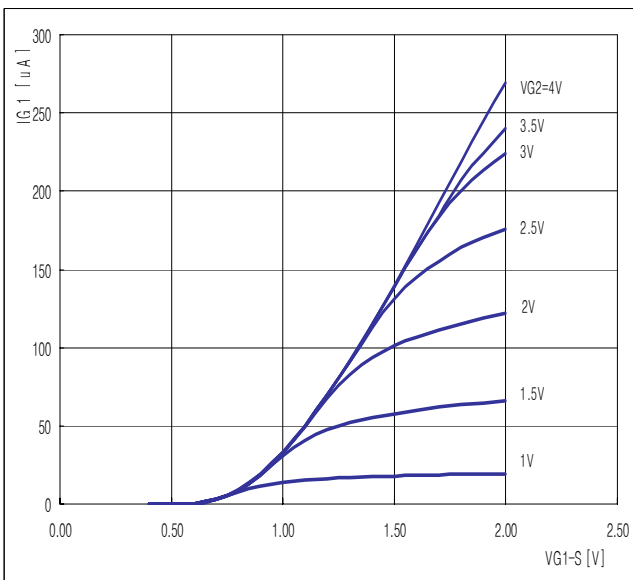

$V_{DS} = 5V, T_j = 25^\circ C$

Fig.4 Gate1 Current as a function of gate1 Voltage

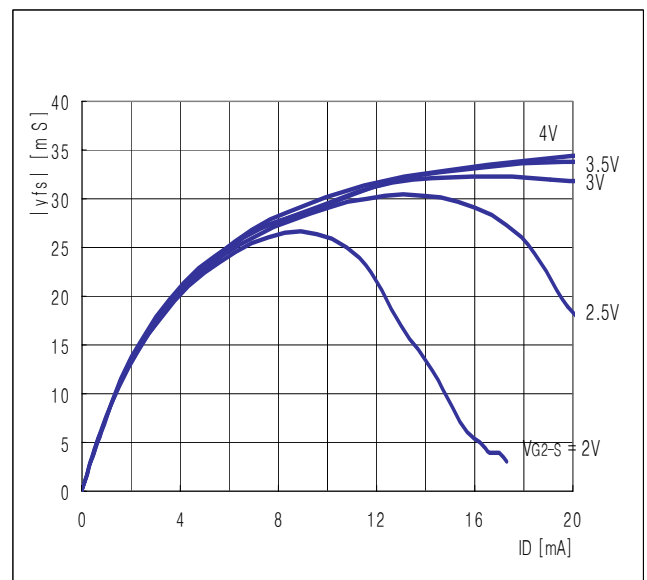

$V_{DS} = 5V, T_j = 25^\circ C$

Fig5. Forward transfer admittance as a function of drain current

□ Graphs For One MOSFET

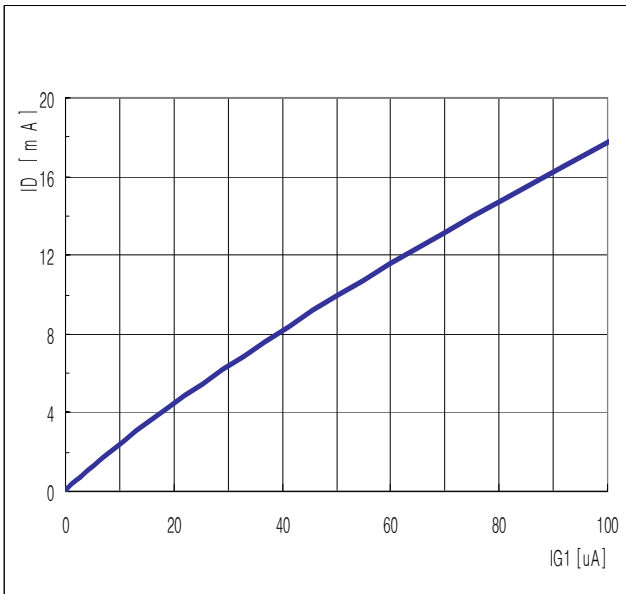

$V_{DS} = 5V, V_{G2-S} = 4V, T_j = 25\text{ }^\circ\text{C}$

Fig6. Drain current as a function of gate1 current

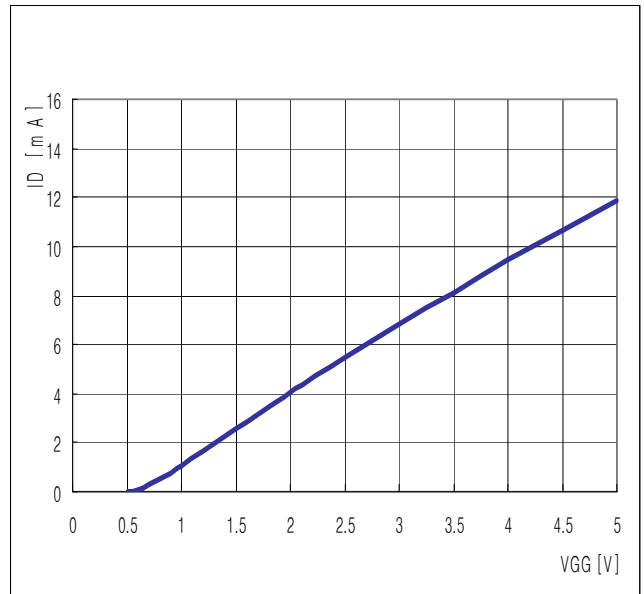

$V_{DS} = 5V, V_{G2-S} = 4V, R_{G1} = 62k\Omega, T_j = 25\text{ }^\circ\text{C}$

Fig7. Drain current as a function of gate1 supply voltage

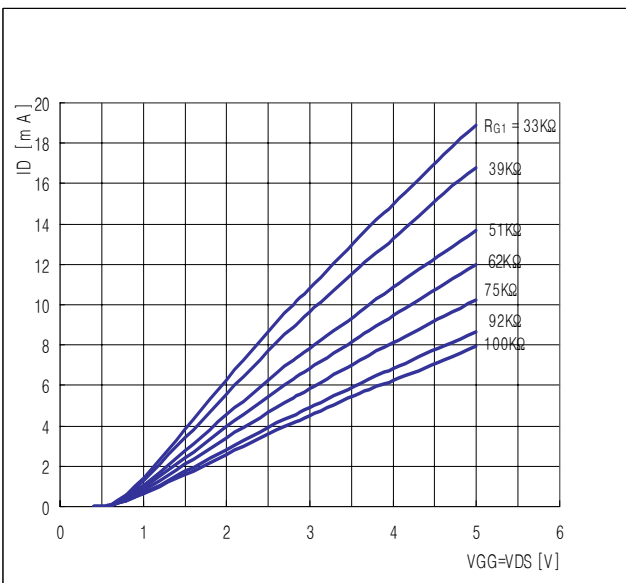

$V_{G2-S} = 4V, T_j = 25\text{ }^\circ\text{C}, R_{G1} = (\text{Connected to VGG})$

Fig8. Drain current as a function of gate1 and drain supply voltage ; see Fig1

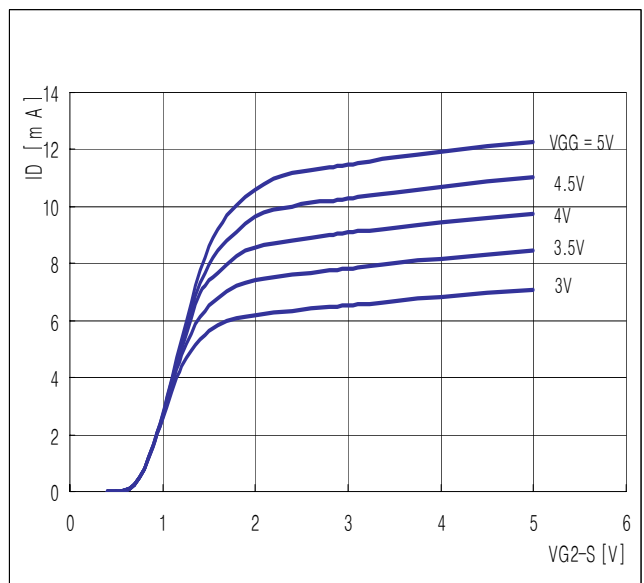

$V_{DS} = 5V, T_j = 25\text{ }^\circ\text{C}, R_{G1} = 62k\Omega$

Fig9. Drain current as a function of gate2 voltage

□ Graphs For One MOSFET

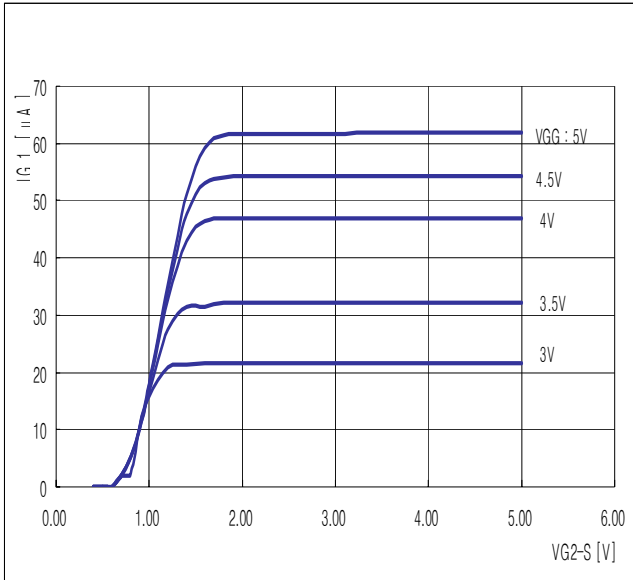

$V_{DS} = 5V$, $R_{GI} = 62k\Omega$, $T_j = 25\text{ }^\circ\text{C}$; Connected to VGG

Fig10. Gate1 current as a function of gate2 voltage

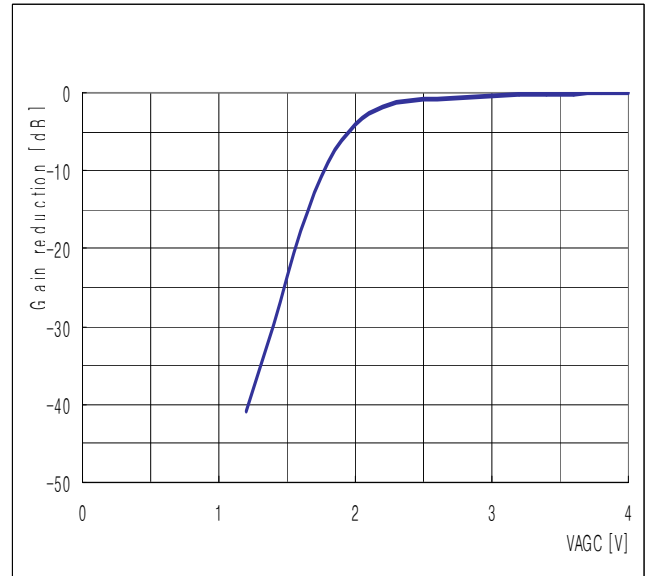

$f = 50\text{MHz}$, $P_{in} = -30\text{dBm}$, $V_{DS} = 5V$, $V_{GG} = 5V$, $R_{GI} = 62k\Omega$, $T_j = 25\text{ }^\circ\text{C}$

Fig11. Typical Gain reduction as a function of AGC Voltage ; see Fig1

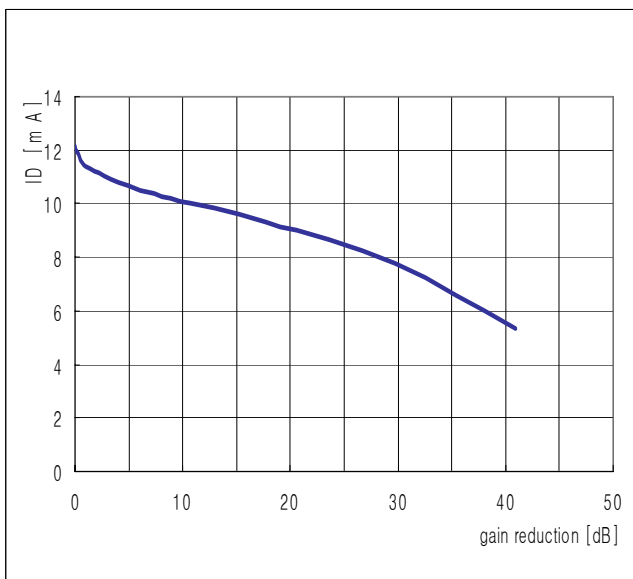

$f = 50\text{MHz}$, $P_{in} = -30\text{dBm}$, $V_{DS} = 5V$, $V_{GG} = 5V$, $R_{GI} = 62k\Omega$

Fig12. Drain current as a function of gain reduction ; see Fig1

□ Graphs For One MOSFET

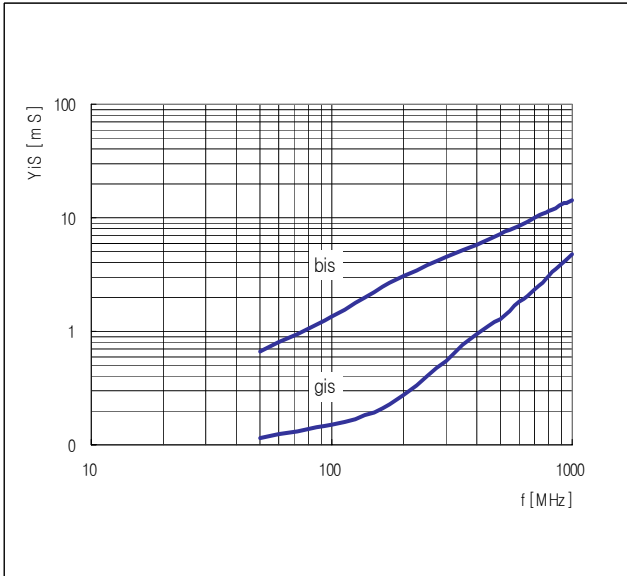

$V_{DS} = 5V, V_{G2-S} = 4V$

Fig13. Input admittance as a function of frequency

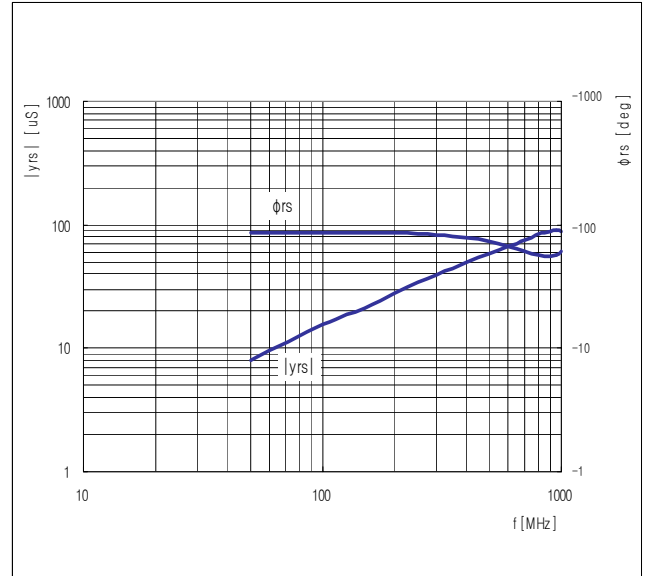

$V_{DS} = 5V, V_{G2-S} = 4V$

Fig14. Reverse transfer admittance and phase as a function of frequency

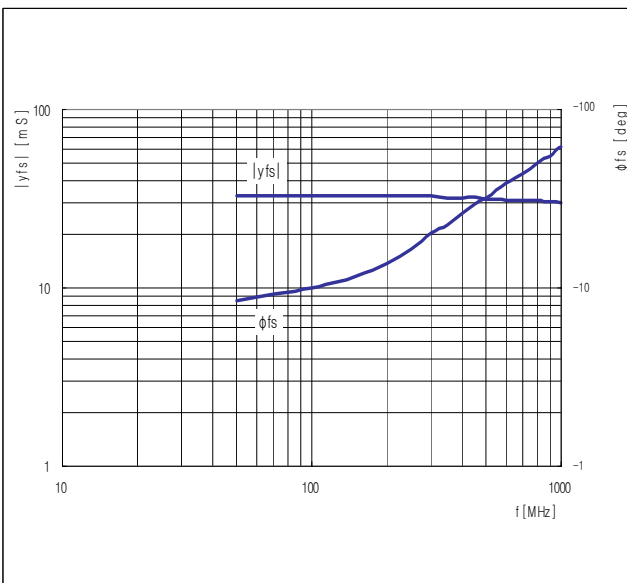

$V_{DS} = 5V, V_{G2-S} = 4V$

Fig15. Forward transfer admittance and phase as a function of frequency

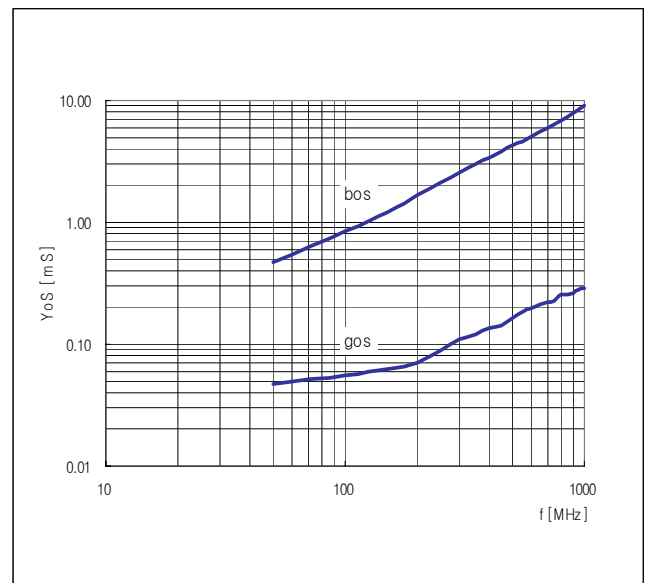

$V_{DS} = 5V, V_{G2-S} = 4V$

Fig16. Output admittance as a function of frequency

Scattering parameters

($V_{G2-S} = 4V$, $V_{DS} = 5V$, $I_D = 12mA$, $T_a = 25\text{ }^\circ\text{C}$)

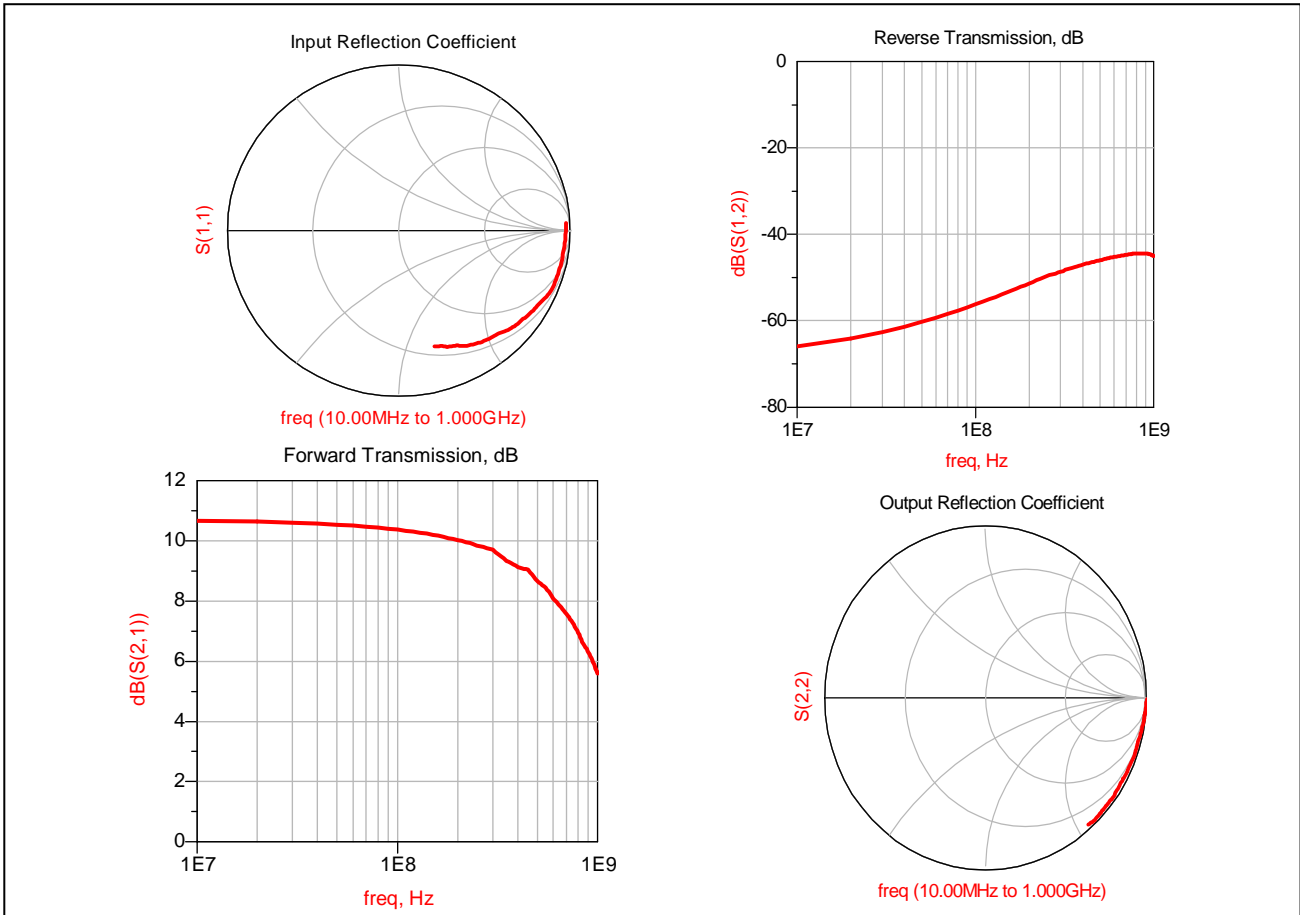

f (MHz)	S11		S21		S12		S22	
	Magnitude (ratio)	Angle (deg)	Magnitude (ratio)	Angle (deg)	Magnitude (ratio)	Angle (deg)	Magnitude (ratio)	Angle (deg)
50	0.972	-1.335	3.366	172.420	0.001	88.960	0.996	-2.468
100	0.969	-6.465	3.301	166.020	0.002	86.210	0.995	-4.957
200	0.963	-16.725	3.172	153.210	0.003	80.730	0.993	-9.935
300	0.943	-25.621	3.056	139.903	0.004	77.220	0.984	-14.987
400	0.914	-33.060	2.862	128.420	0.004	76.136	0.987	-19.550
500	0.889	-39.770	2.711	117.280	0.005	76.090	0.982	-24.580
600	0.850	-46.540	2.540	105.930	0.005	76.970	0.979	-28.830
700	0.828	-54.100	2.391	95.160	0.006	77.860	0.980	-33.830
800	0.791	-61.560	2.220	84.550	0.006	77.315	0.982	-38.460