

Ordering number : ENN7437A



SANYO Semiconductors

# DATA SHEET

## TND027SW — ExPD(Excellent Power Device) TND027TD — Lowside Power Switch Lamp-, Solenoid-, and Motor-Driving Applications

### Features

- N-channel MOSFET built in.
- Overheat protection. (Self recovery type)
- Overcurrent protection. (Self recovery type current limiting function)
- Overvoltage protection.
- Incorporates two sets of circuit.

### Specifications

Absolute Maximum Ratings at Ta=25°C

Parameter	Symbol	Conditions	Ratings	Unit
Drain-to-Source Voltage	V <sub>DS</sub>		60	V
Output Current	I <sub>O</sub> (DC)		1.5	A
Input Voltage	V <sub>IN</sub>		-0.3 to +10	V
Allowable Power Dissipation	P <sub>D</sub>	TND027SW Mounted on a ceramic board (1200mm <sup>2</sup> ×0.8mm)1unit	1.3	W
		TND027SW Mounted on a ceramic board (1200mm <sup>2</sup> ×0.8mm)	1.7	W
		TND027TD Mounted on a ceramic board (1000mm <sup>2</sup> ×0.8mm)1unit	0.8	W
		TND027TD Mounted on a ceramic board (1000mm <sup>2</sup> ×0.8mm)	1.3	W
Operating Supply Voltage	V <sub>DS</sub> (opr)		40	V
Operating Temperature	T <sub>opr</sub>		-40 to +85	°C
Junction Temperature	T <sub>J</sub>		150	°C
Storage Temperature	T <sub>stg</sub>		-55 to +150	°C

- Any and all SANYO products described or contained herein do not have specifications that can handle applications that require extremely high levels of reliability, such as life-support systems, aircraft's control systems, or other applications whose failure can be reasonably expected to result in serious physical and/or material damage. Consult with your SANYO representative nearest you before using any SANYO products described or contained herein in such applications.
- SANYO assumes no responsibility for equipment failures that result from using products at values that exceed, even momentarily, rated values (such as maximum ratings, operating condition ranges, or other parameters) listed in products specifications of any and all SANYO products described or contained herein.



# TND027SW, 027TD

## Electrical Characteristics at Ta=25°C

Parameter	Symbol	Conditions	Ratings			Unit
			min	typ	max	
Drain-to-Source Clamp Voltage	$V_{DS, \text{clamp}}$	$V_{IN}=0, I_O=1\text{mA}$	60			V
Output-OFF Current	$I_{DSS(1)}$	$V_{IN}=0, V_{DS}=50\text{V}$			10	$\mu\text{A}$
	$I_{DSS(2)}$	$V_{IN}=0, V_{DS}=12\text{V}$			5	$\mu\text{A}$
Input Threshold Voltage	$V_{IN(th)}$	$V_{DS}=5\text{V}, I_O=1\text{mA}$	1.0	1.5	2.0	V
Protection Circuit Operating Input Voltage	$V_{IN(opr)}$		4		10	V
Drain-to-Source ON Resistance	$R_{DS(on)}$	$V_{IN}=5\text{V}, I_O=1\text{A}$		0.3	0.4	$\Omega$
Input Current (Output On)	$I_{IN}$	$V_{IN}=5\text{V}$			0.6	mA
Over-Heat Detecting Temperature	$T_{j(sd)}$	$V_{IN}=5\text{V}, I_O=1\text{A}$	120	150	190	°C
Over-Current Detecting Current	$I_s$	$V_{IN}=5\text{V}$	3.0	6.0	9.0	A
Over-Current Limit (Peak)	$I_{LMT}$	$V_{IN}=5\text{V}$	3.0	6.0	9.0	A
Input Clamp Voltage	$V_{IN, \text{clamp}}$	$I_{IN}=1\text{mA}$	10			V

Notes : 1. Overcurrent protection circuit limits the output current to the range of overcurrent limit value.  
 2. During overheat protecting operation, output current is turned off.

### Package Dimensions

unit : mm

2181 [TND027SW]

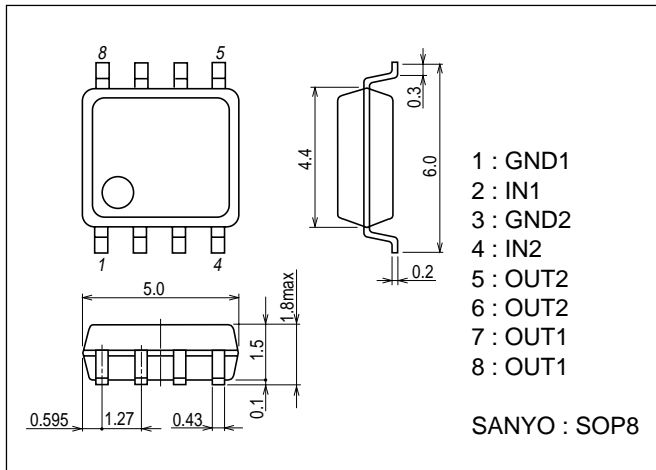

### Package Dimensions

unit : mm

2219 [TND027TD]

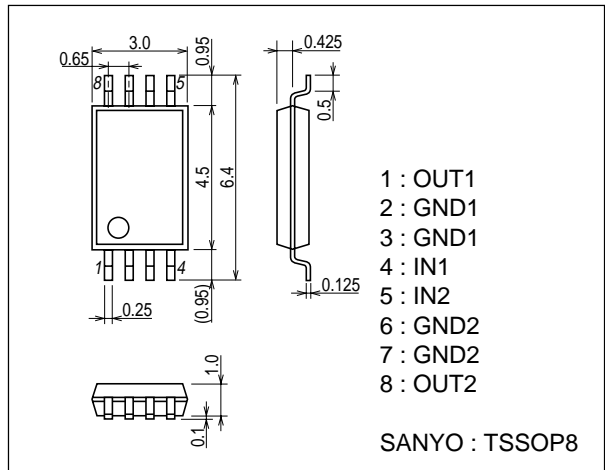

### Block Diagram

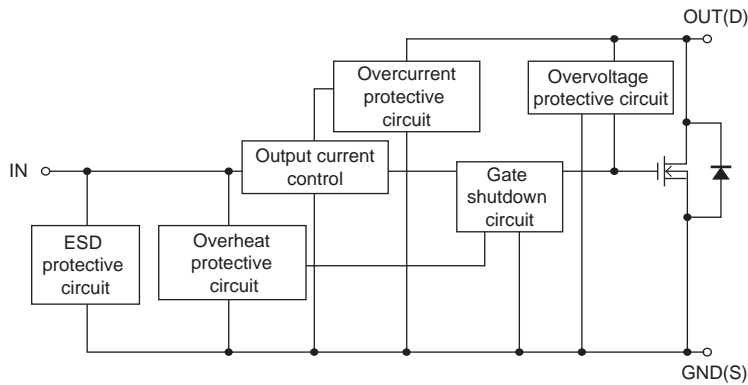

# TND027SW, 027TD

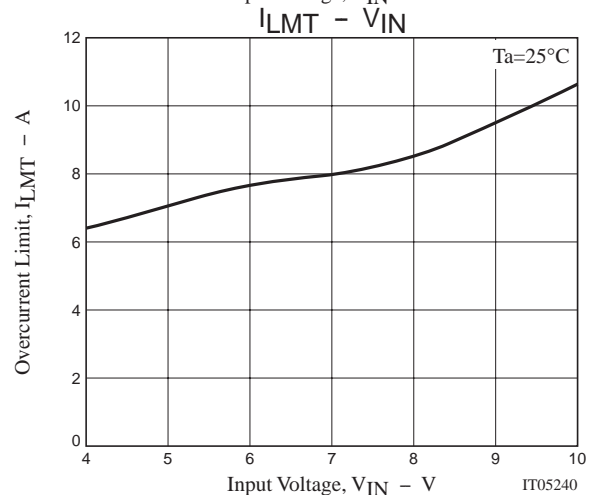
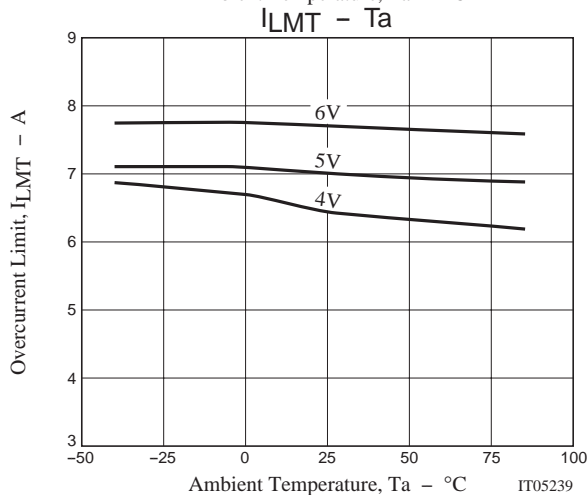
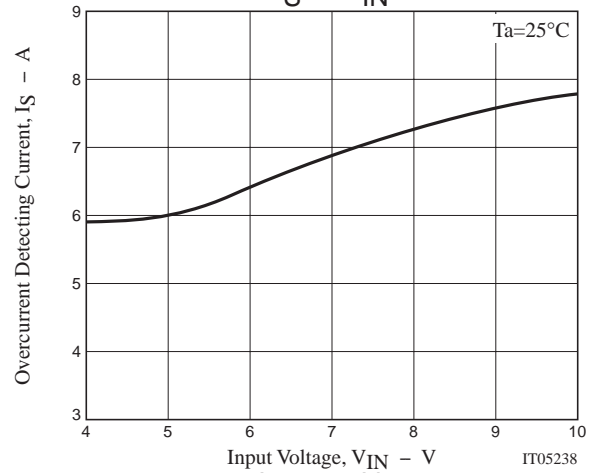
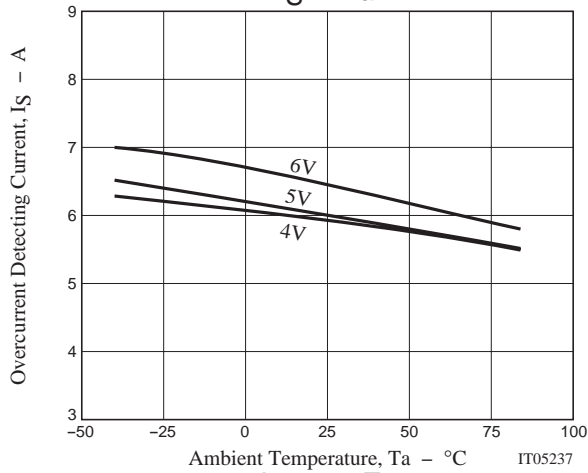
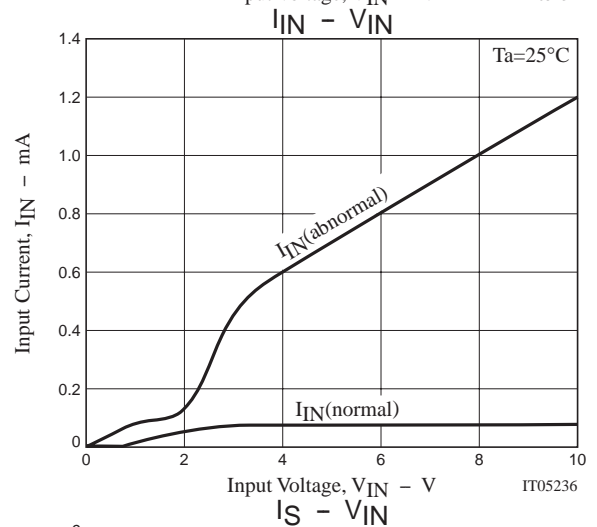
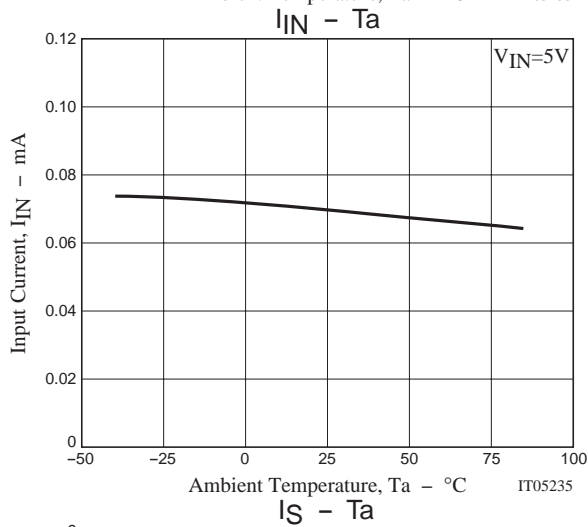
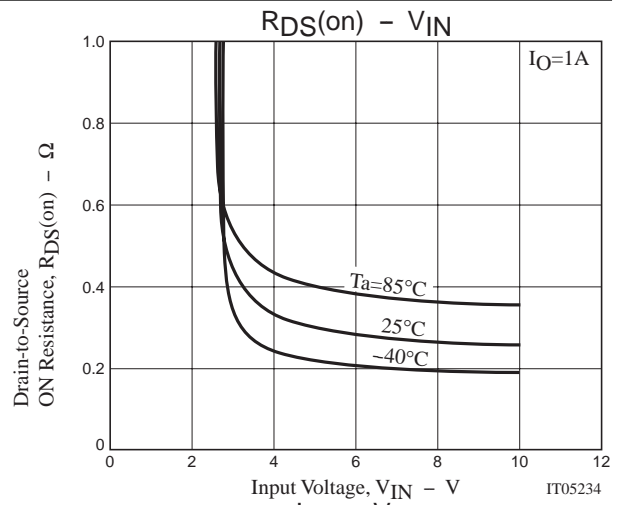
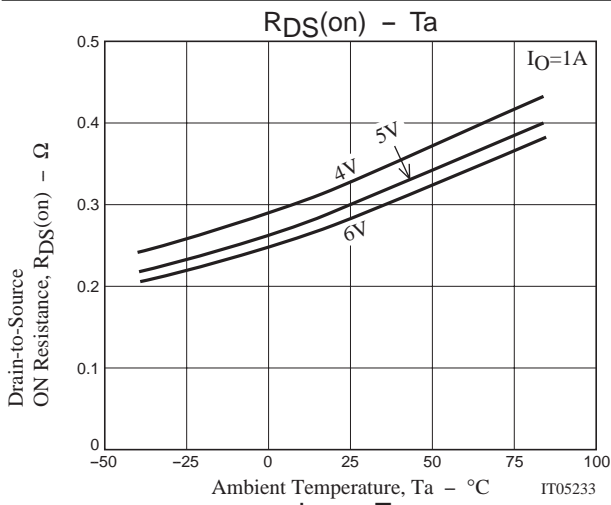

# TND027SW, 027TD

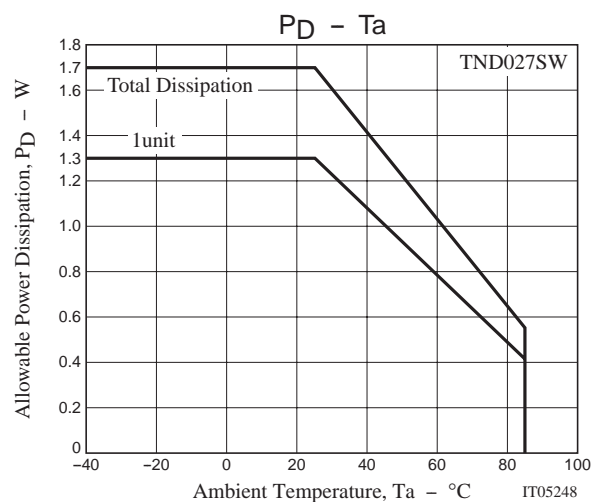
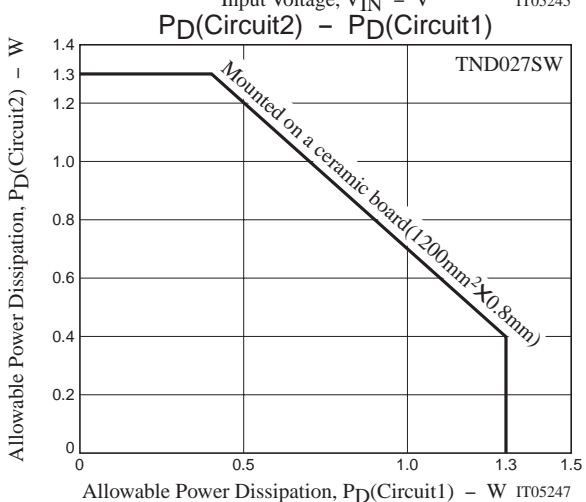
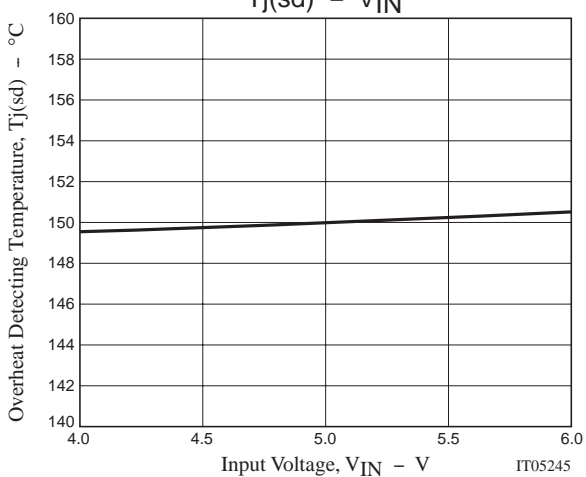
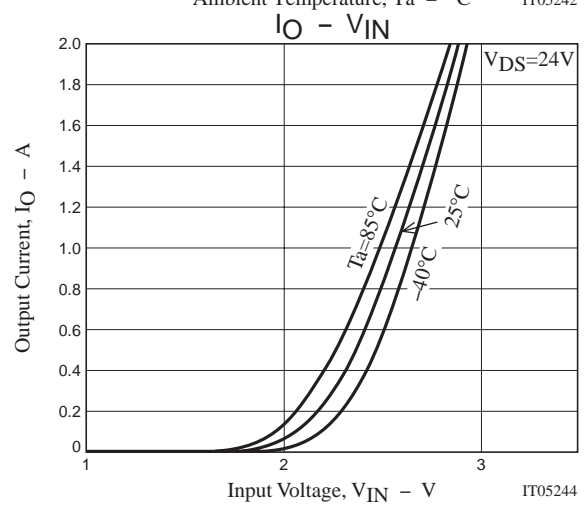
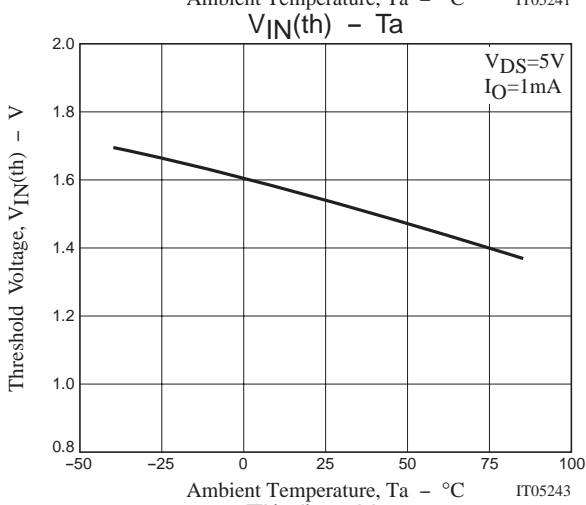
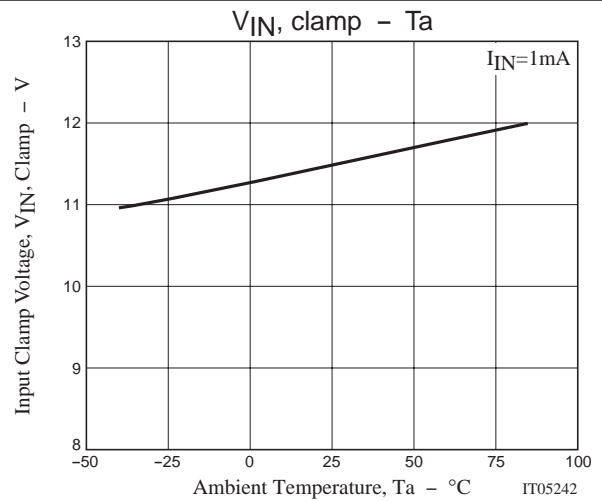
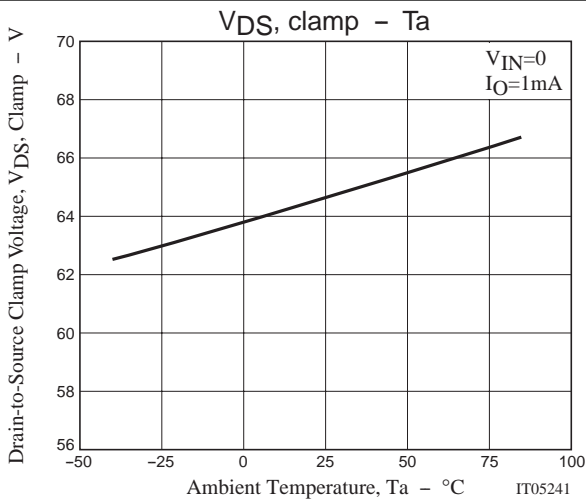

## TND027SW, 027TD

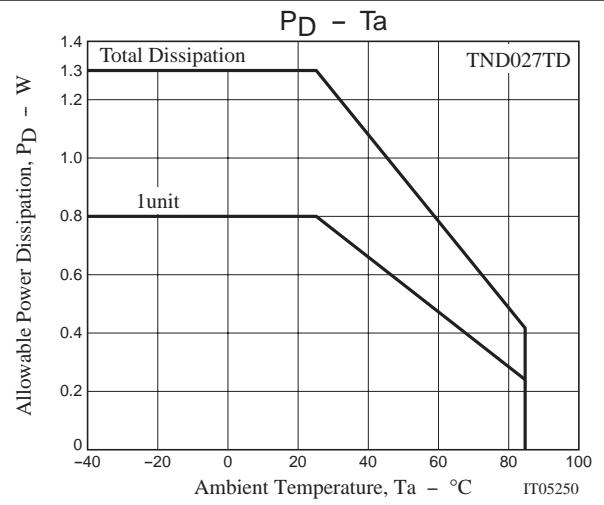
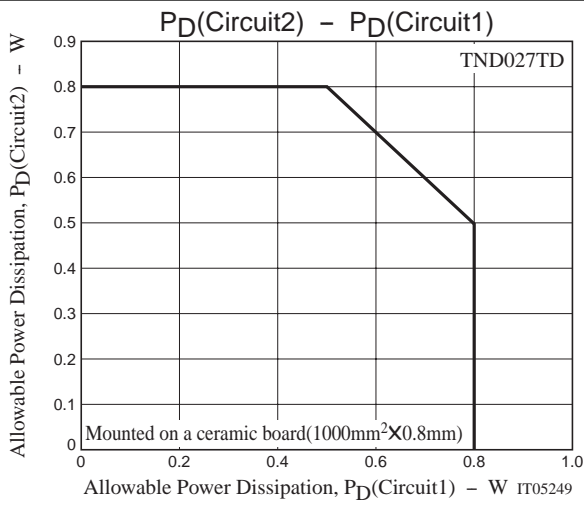

### Sample Application Circuit

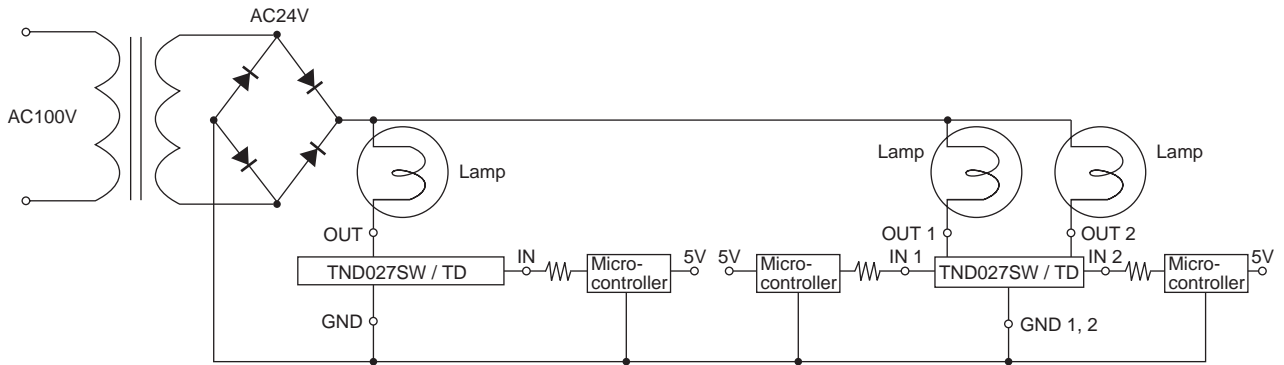

### Another Sample Application Circuit (Solenoid drive)

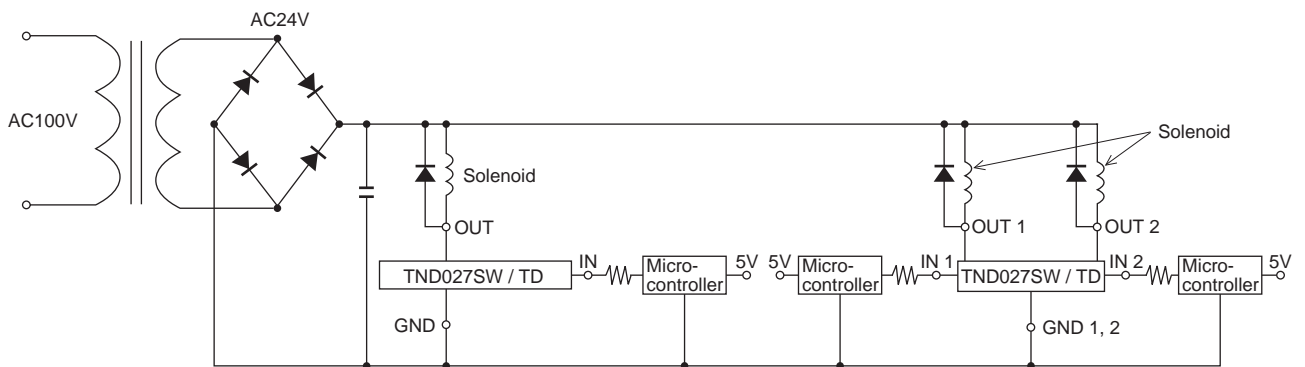

## TND027SW, 027TD

---

### Operation Description

- The output power MOSFET will be turned on when the input voltage exceeds the input threshold voltage (4 to 6V is recommended), and then the lamp will be turned on by the current flowing to the lamp. Conversely, the output power MOSFET will be turned off when the input voltage goes below the input threshold voltage, and the lamp will be turned off.
- The inrush current that occurs during normal lamp operation is limited to a preset value by the built-in overcurrent protecting circuit, which makes the lamp life longer.
- The internal overcurrent protection function limits the current of output power MOSFET when output current of at least the overcurrent detecting current value flows at load short. Besides, if the device temperature exceeds the allowable power dissipation, overheat protection function protects the power switch from being broken down by turning off the current of output power MOSFET when  $T_j$  comes to 150°C (typical).
- As an example of application circuit, DC voltage can also be controlled as a solenoid drive.

- Specifications of any and all SANYO products described or contained herein stipulate the performance, characteristics, and functions of the described products in the independent state, and are not guarantees of the performance, characteristics, and functions of the described products as mounted in the customer's products or equipment. To verify symptoms and states that cannot be evaluated in an independent device, the customer should always evaluate and test devices mounted in the customer's products or equipment.
- SANYO Electric Co., Ltd. strives to supply high-quality high-reliability products. However, any and all semiconductor products fail with some probability. It is possible that these probabilistic failures could give rise to accidents or events that could endanger human lives, that could give rise to smoke or fire, or that could cause damage to other property. When designing equipment, adopt safety measures so that these kinds of accidents or events cannot occur. Such measures include but are not limited to protective circuits and error prevention circuits for safe design, redundant design, and structural design.
- In the event that any or all SANYO products (including technical data, services) described or contained herein are controlled under any of applicable local export control laws and regulations, such products must not be exported without obtaining the export license from the authorities concerned in accordance with the above law.
- No part of this publication may be reproduced or transmitted in any form or by any means, electronic or mechanical, including photocopying and recording, or any information storage or retrieval system, or otherwise, without the prior written permission of SANYO Electric Co., Ltd.
- Any and all information described or contained herein are subject to change without notice due to product/technology improvement, etc. When designing equipment, refer to the "Delivery Specification" for the SANYO product that you intend to use.
- Information (including circuit diagrams and circuit parameters) herein is for example only ; it is not guaranteed for volume production. SANYO believes information herein is accurate and reliable, but no guarantees are made or implied regarding its use or any infringements of intellectual property rights or other rights of third parties.

This catalog provides information as of October, 2003. Specifications and information herein are subject to change without notice.

---