

1-W MONO AUDIO POWER AMPLIFIER

FEATURES

- 1-W BTL Output (5 V, 0.11 % THD+N)
- 3.3-V and 5-V Operation
- No Output Coupling Capacitors Required
- Shutdown Control ($I_{DD} = 0.6 \mu\text{A}$)
- Uncompensated Gains of 2 to 20 (BTL Mode)
- Surface-Mount Packaging
- Thermal and Short-Circuit Protection
- High Supply Ripple Rejection Ratio (56 dB at 1 kHz)
- LM4861 Drop-In Compatible

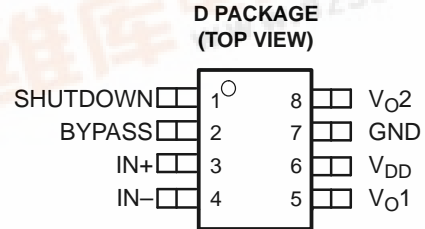

DESCRIPTION

The TPA4861 is a bridge-tied load (BTL) audio power amplifier capable of delivering 1 W of continuous average power into an 8- Ω load at 0.2% THD+N from a 5-V power supply in voiceband frequencies ($f < 5$ kHz). A BTL configuration eliminates the need for external coupling capacitors on the output in most applications. Gain is externally configured by means of two resistors and does not require compensation for settings of 2 to 20. Features of the amplifier are a shutdown function for power-sensitive applications as well as internal thermal and short-circuit protection. The TPA4861 works seamlessly with TI's TPA4860 in stereo applications. The amplifier is available in an 8-pin SOIC surface-mount package that reduces board space and facilitates automated assembly.

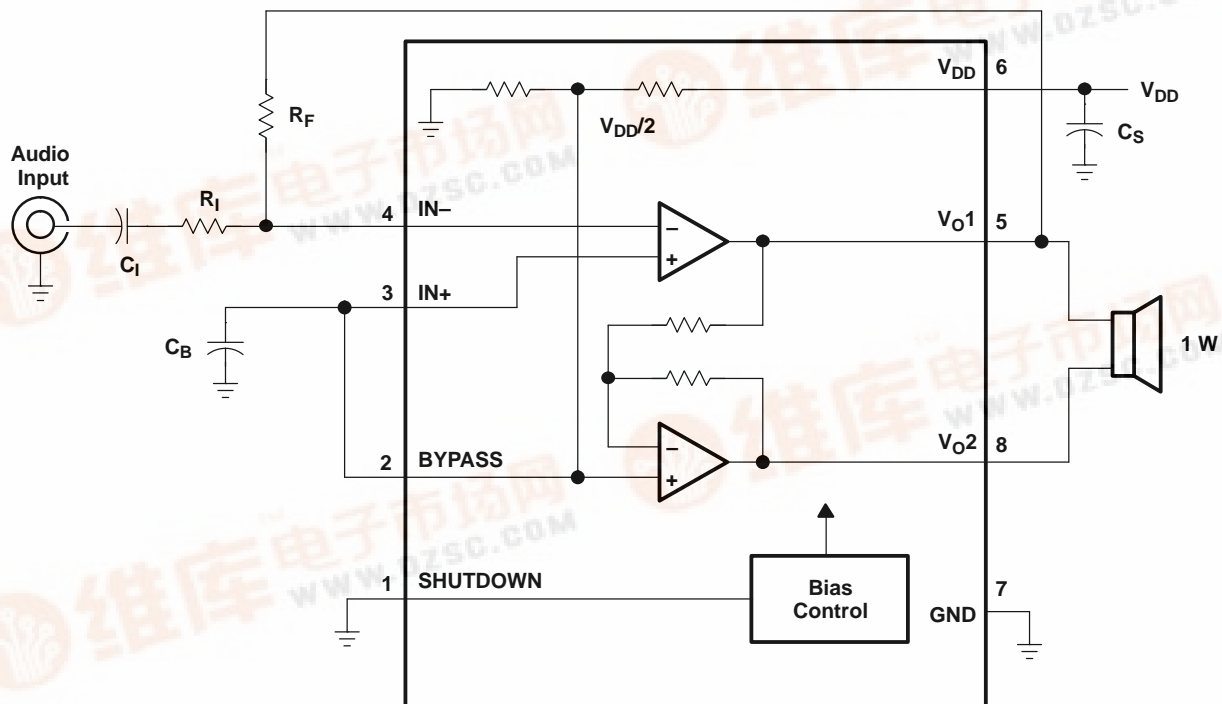

TPA4861

SLOS163C – SEPTEMBER 1996 – REVISED JUNE 2004



These devices have limited built-in ESD protection. The leads should be shorted together or the device placed in conductive foam during storage or handling to prevent electrostatic damage to the MOS gates.

AVAILABLE OPTIONS

T_A	PACKAGED DEVICE
	SMALL OUTLINE ⁽¹⁾ (D)
–40°C to 85°C	TPA4861D

(1) The D package is available tape and reeled. To order a tape and reeled part, add the suffix R to the part number (e.g., TPA4861DR).

Terminal Functions

TERMINAL NAME	NO.	I/O	DESCRIPTION
BYPASS	2	I	BYPASS is the tap to the voltage divider for internal mid-supply bias. This terminal should be connected to a 0.1- μ F – 1.0- μ F capacitor when used as an audio power amplifier.
GND	7		GND is the ground connection.
IN-	4	I	IN- is the inverting input. IN- is typically used as the audio input terminal.
IN+	3	I	IN+ is the noninverting input. IN+ is typically tied to the BYPASS terminal.
SHUTDOWN	1	I	SHUTDOWN places the entire device in shutdown mode when held high ($I_{DD} \sim 0.6 \mu A$).
V_{O1}	5	O	V_{O1} is the positive BTL output.
V_{O2}	8	O	V_{O2} is the negative BTL output.
V_{DD}	6		V_{DD} is the supply voltage terminal.

ABSOLUTE MAXIMUM RATINGS

over operating free-air temperature range (unless otherwise noted)⁽¹⁾

	UNIT
V_{DD} Supply voltage	6 V
V_I Input voltage	–0.3 V to $V_{DD} + 0.3$ V
Continuous total power dissipation	Internally Limited (see Dissipation Rating Table)
T_A Operating free-air temperature range	–40°C to 85°C
T_J Operating junction temperature range	–40°C to 150°C
T_{stg} Storage temperature range	–65°C to 150°C
Lead temperature 1,6 mm (1/16 inch) from case for 10 seconds	260°C

(1) Stresses beyond those listed under "absolute maximum ratings" may cause permanent damage to the device. These are stress ratings only, and functional operation of the device at these or any other conditions beyond those indicated under "recommended operating conditions" is not implied. Exposure to absolute-maximum-rated conditions for extended periods may affect device reliability.

DISSIPATION RATING TABLE

PACKAGE	$T_A \leq 25^\circ\text{C}$	DERATING FACTOR	$T_A = 70^\circ\text{C}$	$T_A = 85^\circ\text{C}$
D	725 mW	5.8 mW/°C	464 mW	377 mW

RECOMMENDED OPERATING CONDITIONS

	MIN	MAX	UNIT
V_{DD} Supply voltage	2.7	5.5	V
V_{IC} Common-mode input voltage	$V_{DD} = 3$ V	1.25	2.7
	$V_{DD} = 5$ V	1.25	4.5
T_A Operating free-air temperature	–40	85	°C

ELECTRICAL CHARACTERISTICS

 at specified free-air temperature, $V_{DD} = 3.3\text{ V}$ (unless otherwise noted)

PARAMETER	TEST CONDITIONS	TPA4861			UNIT
		MIN	TYP	MAX	
V_{OO} Output offset voltage	See ⁽¹⁾			20	mV
PSRR Power supply rejection ratio ($\Delta V_{DD}/\Delta V_{OO}$)	$V_{DD} = 3.2\text{ V to }3.4\text{ V}$		75		dB
I_{DD} Supply current			2.5		mA
$I_{DD(SD)}$ Supply current, shutdown			0.6		μA

 (1) At $3\text{ V} < V_{DD} < 5\text{ V}$ the dc output voltage is approximately $V_{DD}/2$.

OPERATING CHARACTERISTICS

 $V_{DD} = 3.3\text{ V}$, $T_A = 25^\circ\text{C}$, $R_L = 8\ \Omega$

PARAMETER	TEST CONDITIONS	TPA4861			UNIT
		MIN	TYP	MAX	
P_O Output power ⁽¹⁾	THD = 0.2%, $f = 1\text{ kHz}$, $A_V = -2\text{ V/V}$		400		mW
	THD = 2%, $f = 1\text{ kHz}$, $A_V = -2\text{ V/V}$		500		mW
B_{OM} Maximum output power bandwidth	Gain = -10 V/V , THD = 2%		20		kHz
B_1 Unity-gain bandwidth	Open Loop		1.5		MHz
Supply ripple rejection ratio	BTL $f = 1\text{ kHz}$, $C_B = 0.1\ \mu\text{F}$		56		dB
	SE $f = 1\text{ kHz}$, $C_B = 0.1\ \mu\text{F}$		30		dB
V_n Noise output voltage ⁽²⁾	Gain = -2 V/V		20		μV

(1) Output power is measured at the output terminals of the device.

(2) Noise voltage is measured in a bandwidth of 20 Hz to 20 kHz.

ELECTRICAL CHARACTERISTICS

 at specified free-air temperature range, $V_{DD} = 5\text{ V}$ (unless otherwise noted)

PARAMETER	TEST CONDITION	TPA4861			UNIT
		MIN	TYP	MAX	
V_{OO} Output offset voltage	See ⁽¹⁾			20	mV
PSRR Power supply rejection ratio ($\Delta V_{DD}/\Delta V_{OO}$)	$V_{DD} = 4.9\text{ V to }5.1\text{ V}$		70		dB
I_{DD} Supply current			3.5		mA
$I_{DD(SD)}$ Supply current, shutdown			0.6		μA

 (1) At $3\text{ V} < V_{DD} < 5\text{ V}$ the dc output voltage is approximately $V_{DD}/2$.

OPERATING CHARACTERISTICS

 $V_{DD} = 5\text{ V}$, $T_A = 25^\circ\text{C}$, $R_L = 8\ \Omega$

PARAMETER	TEST CONDITIONS	TPA4861			UNIT
		MIN	TYP	MAX	
P_O Output power ⁽¹⁾	THD = 0.2%, $f = 1\text{ kHz}$, $A_V = -2\text{ V/V}$		1000		mW
	THD = 2%, $f = 1\text{ kHz}$, $A_V = -2\text{ V/V}$		1100		mW
B_{OM} Maximum output power bandwidth	Gain = -10 V/V , THD = 2%		20		kHz
B_1 Unity-gain bandwidth	Open Loop		1.5		MHz
Supply ripple rejection ratio	BTL $f = 1\text{ kHz}$, $C_B = 0.1\ \mu\text{F}$		56		dB
	SE $f = 1\text{ kHz}$, $C_B = 0.1\ \mu\text{F}$		30		dB
V_n Noise output voltage ⁽²⁾	Gain = -2 V/V		20		μV

(1) Output power is measured at the output terminals of the device.

(2) Noise voltage is measured in a bandwidth of 20 Hz to 20 kHz.

TYPICAL CHARACTERISTICS

Table of Graphs

			FIGURE
V_{OO}	Output offset voltage	Distribution	1, 2
I_{DD}	Supply current distribution	vs Free-air temperature	3, 4
THD+N	Total harmonic distortion plus noise	vs Frequency	5, 6, 7, 8, 9, 10,11,15, 16,17,18
		vs Output power	12, 13, 14, 19,20,21
I_{DD}	Supply current	vs Supply voltage	22
V_n	Output noise voltage	vs Frequency	23, 24
	Maximum package power dissipation	vs Free-air temperature	25
	Power dissipation	vs Output power	26, 27
	Maximum output power	vs Free-air temperature	28
	Output power	vs Load resistance	29
		vs Supply voltage	30
	Open-loop gain	vs Frequency	31
k_{SVR}	Supply ripple rejection ratio	vs Frequency	32, 33

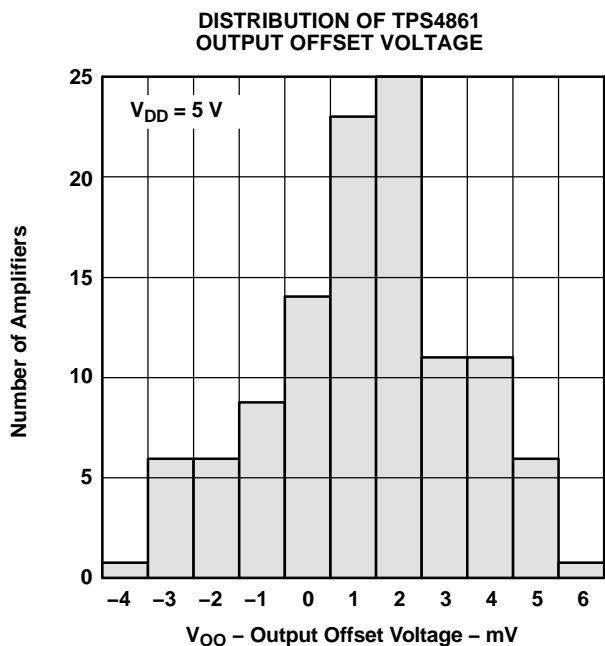

Figure 1.

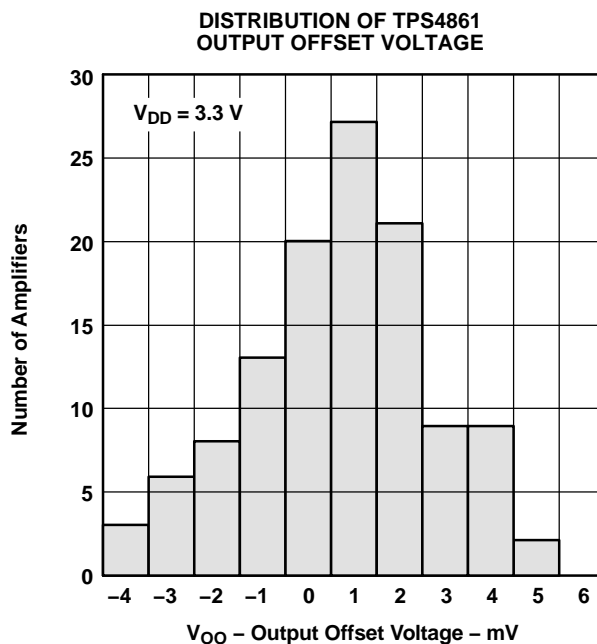

Figure 2.

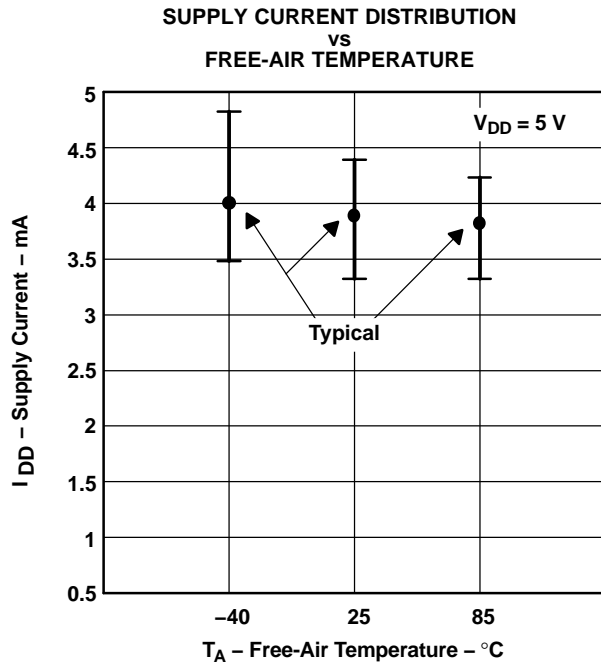

Figure 3.

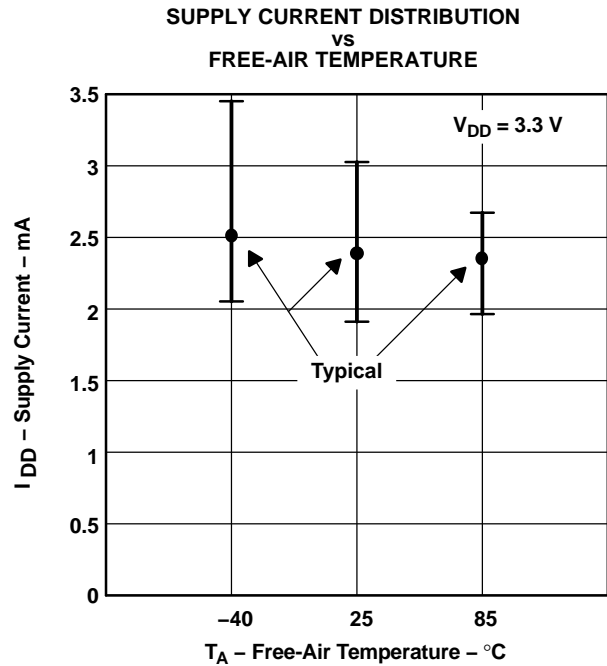

Figure 4.

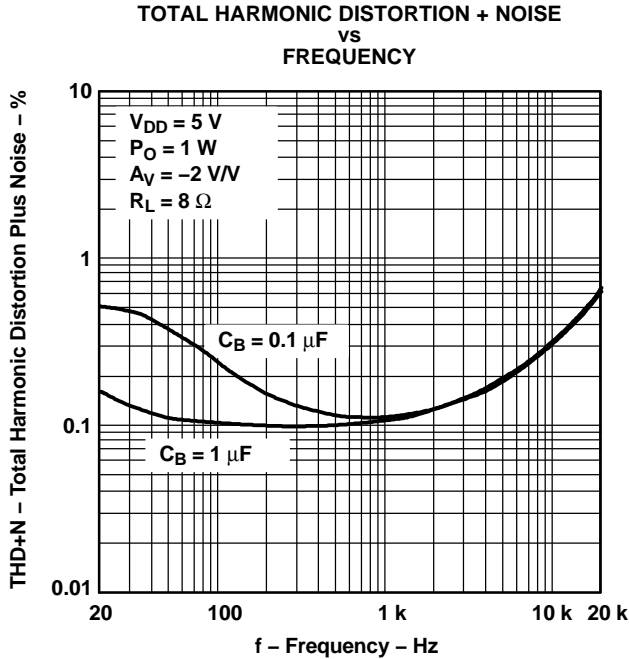

Figure 5.

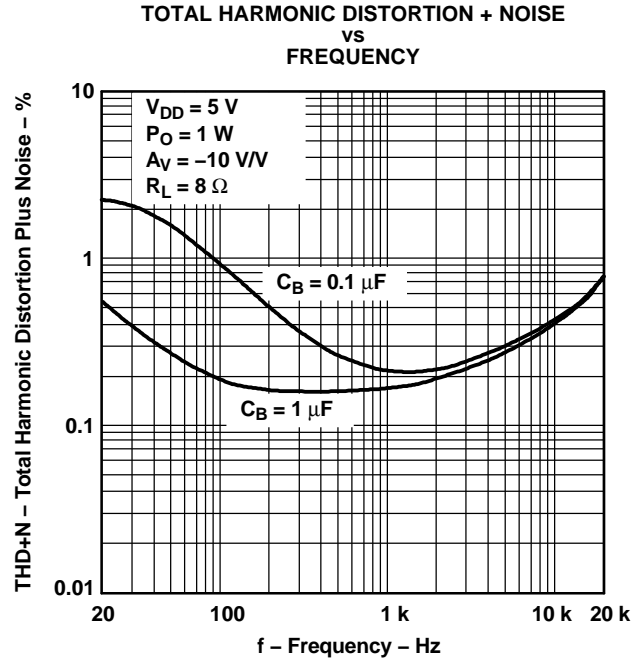

Figure 6.

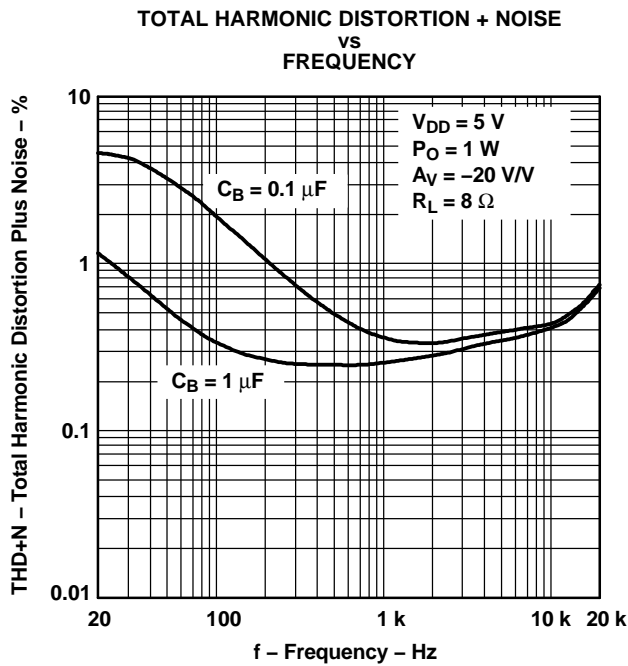

Figure 7.

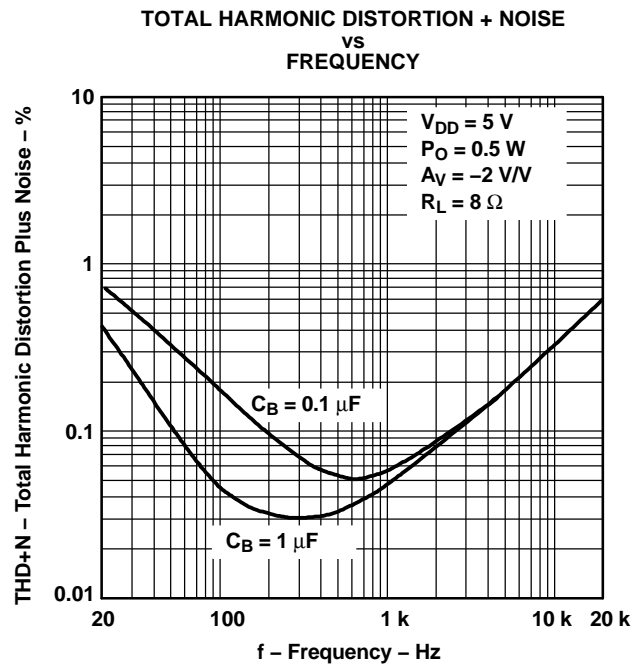

Figure 8.

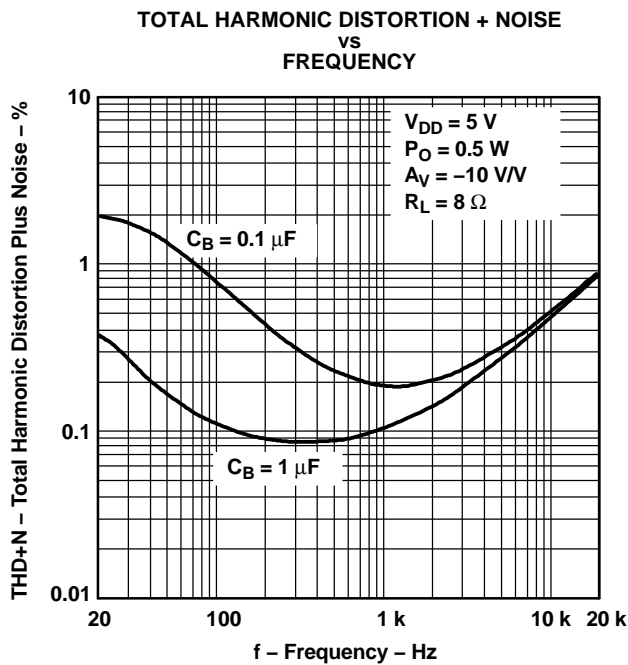

Figure 9.

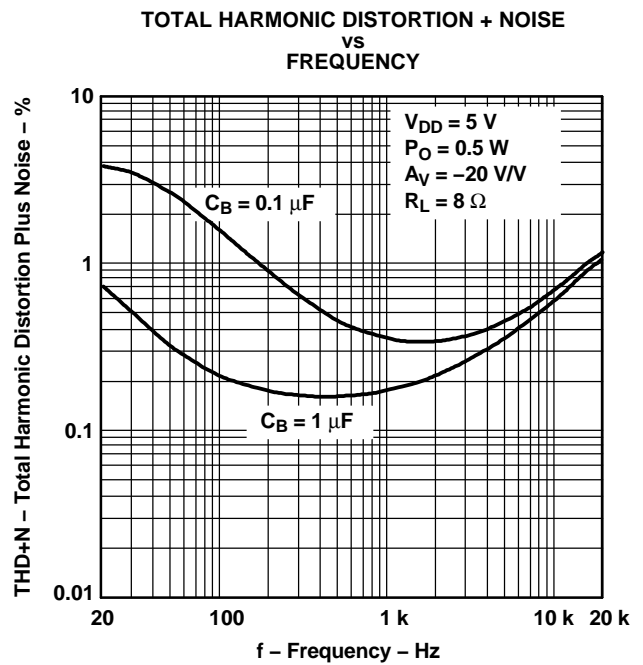

Figure 10.

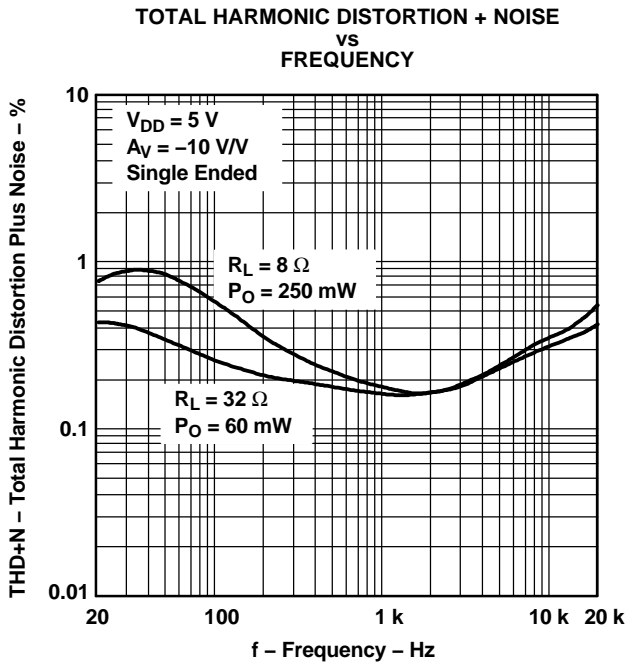

Figure 11.

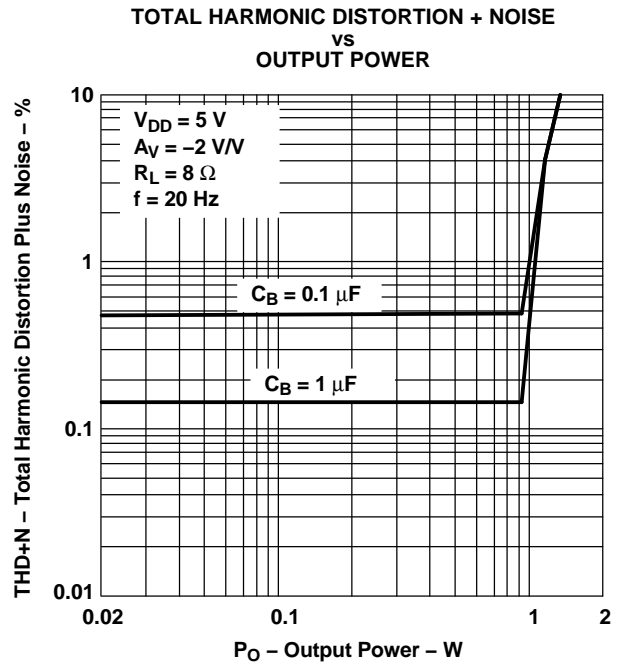

Figure 12.

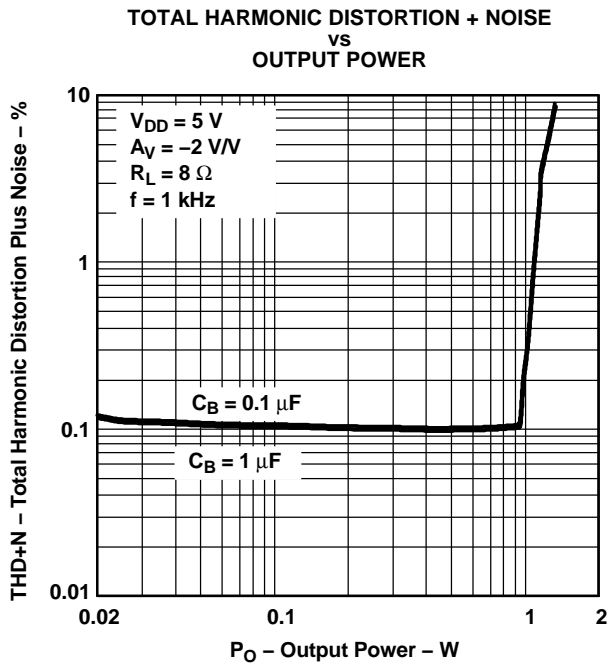

Figure 13.

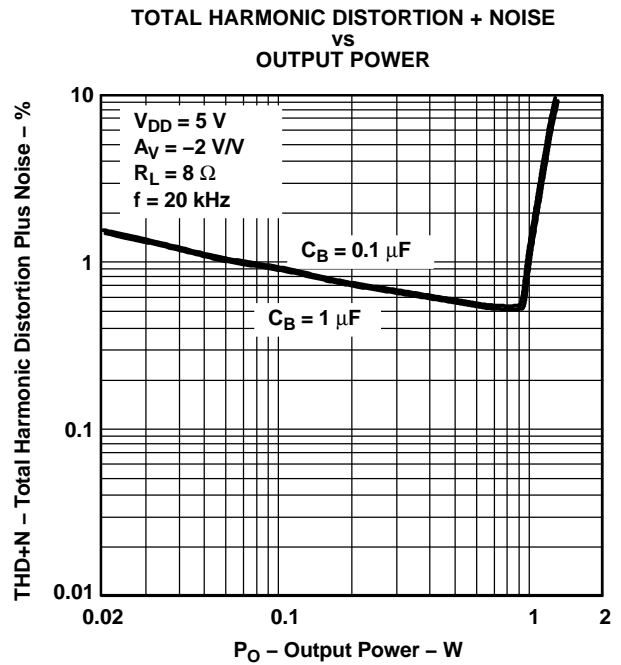

Figure 14.

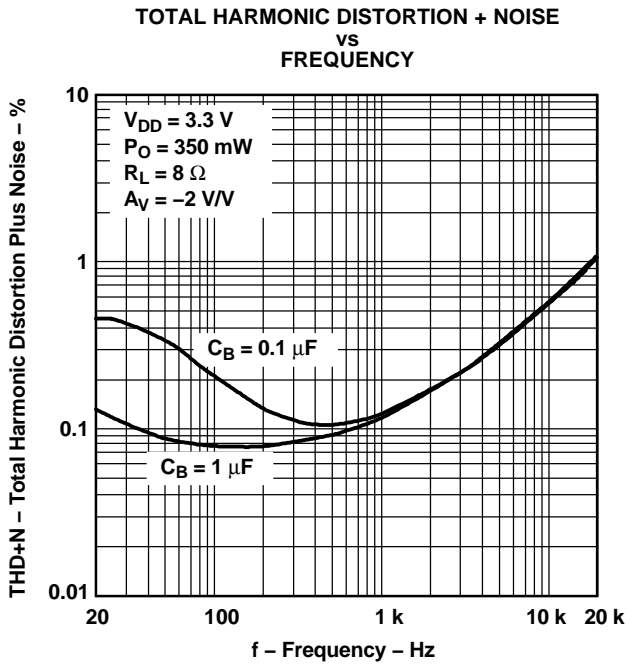

Figure 15.

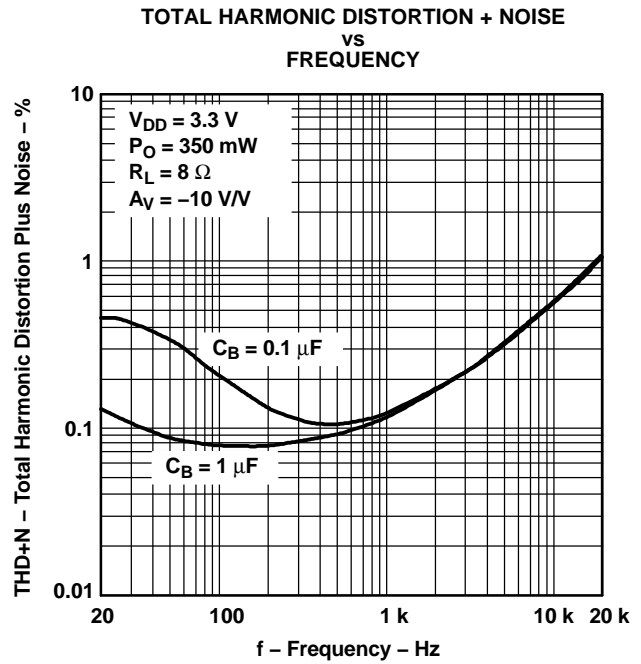

Figure 16.

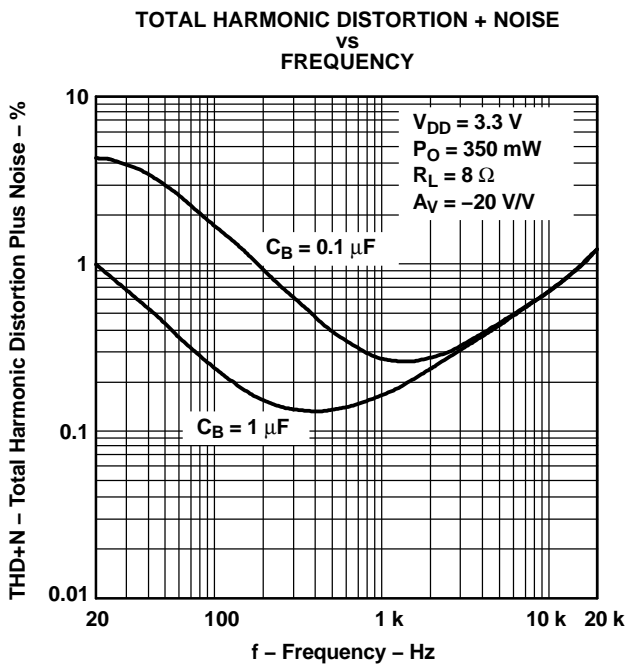

Figure 17.

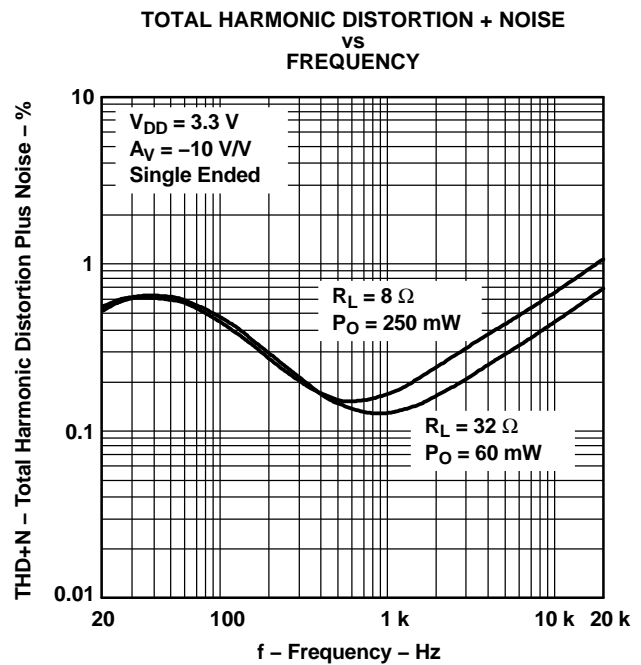

Figure 18.

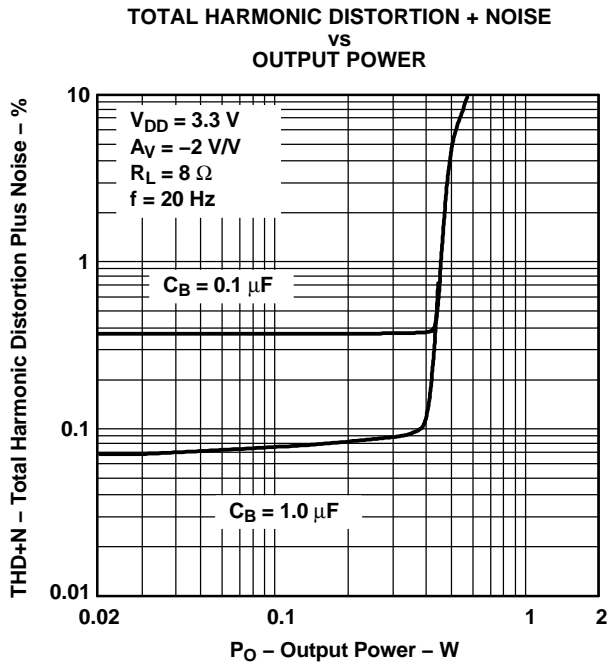

Figure 19.

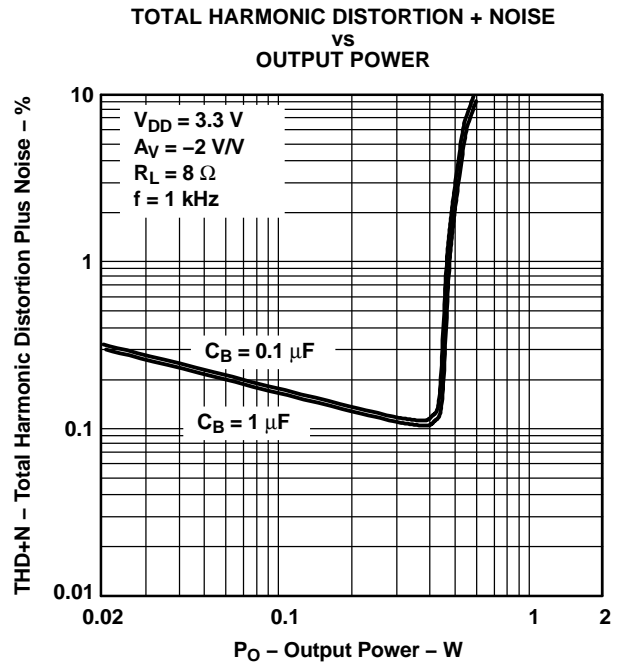

Figure 20.

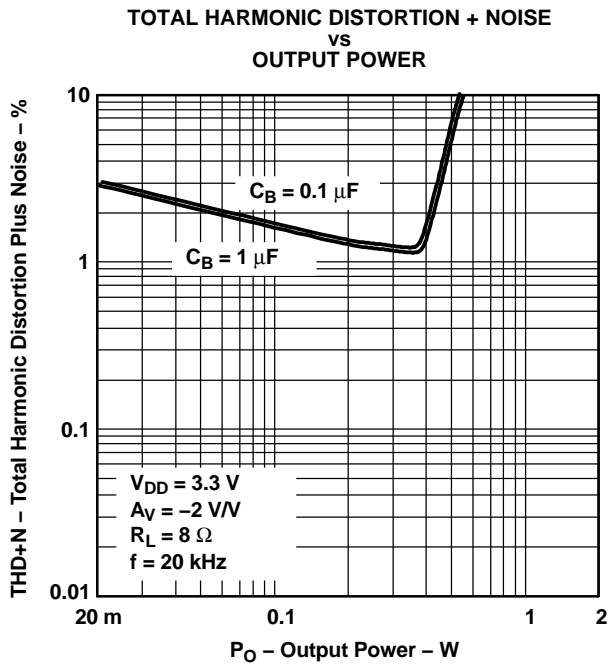

Figure 21.

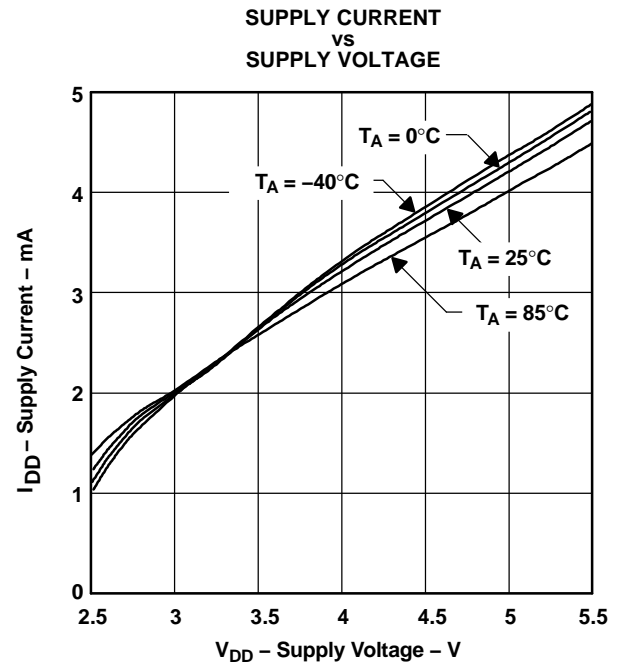

Figure 22.

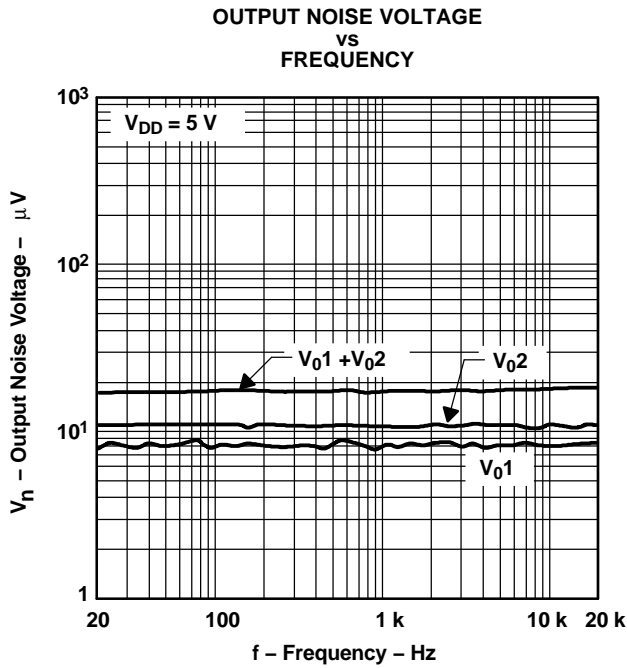

Figure 23.

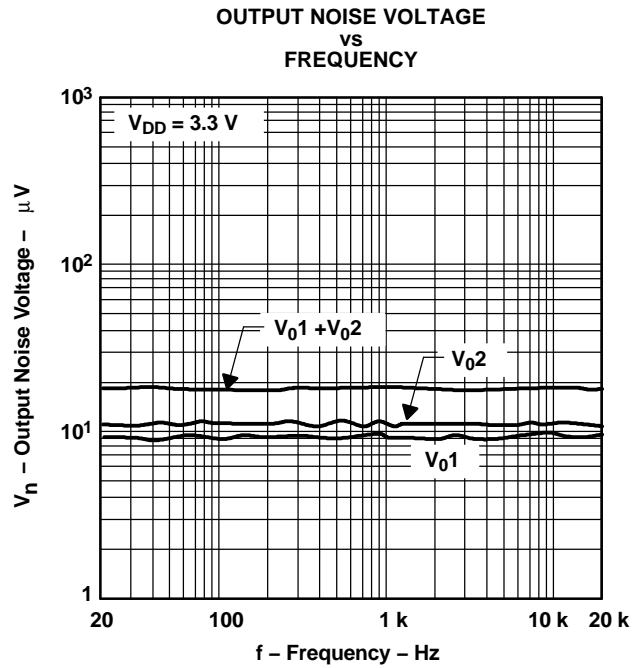

Figure 24.

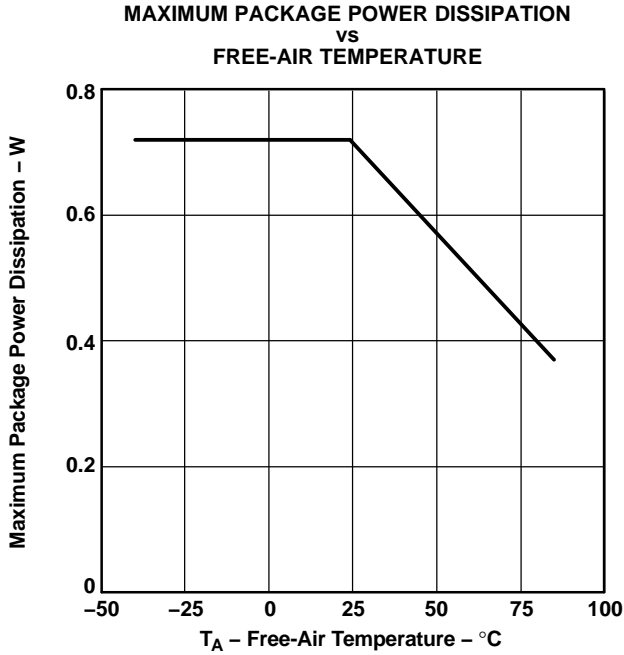

Figure 25.

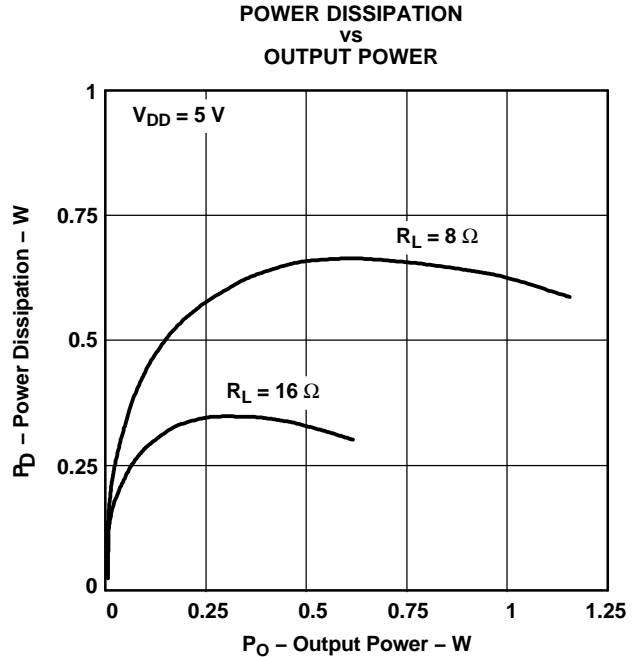

Figure 26.

**POWER DISSIPATION
vs
OUTPUT POWER**

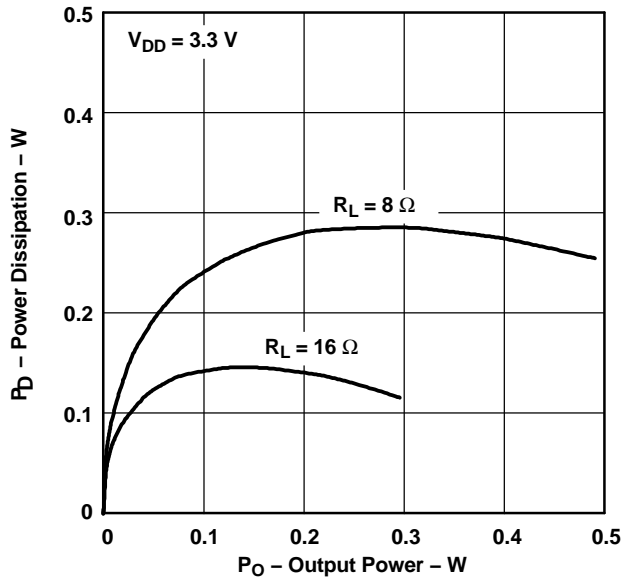

Figure 27.

**MAXIMUM OUTPUT POWER
vs
FREE-AIR TEMPERATURE**

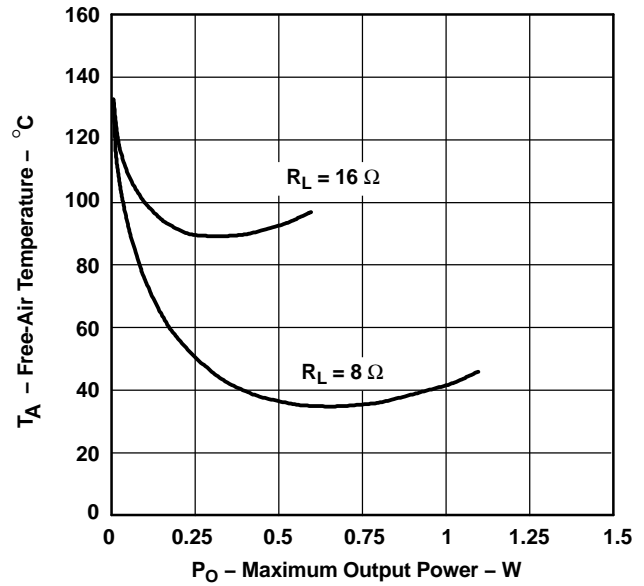

Figure 28.

**OUTPUT POWER
vs
LOAD RESISTANCE**

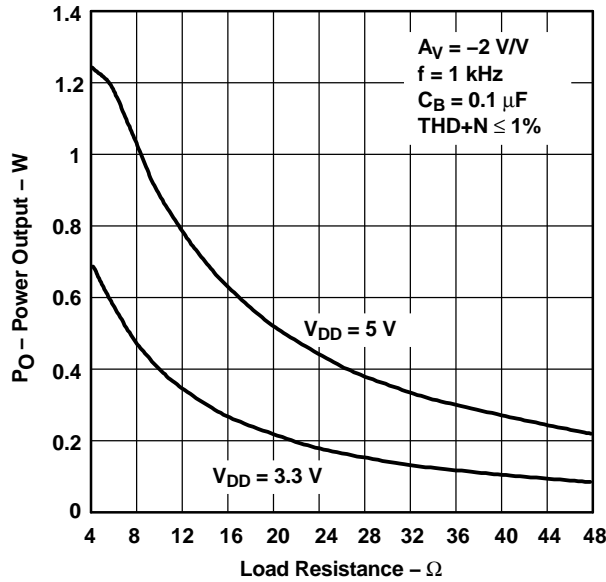

Figure 29.

**OUTPUT POWER
vs
SUPPLY VOLTAGE**

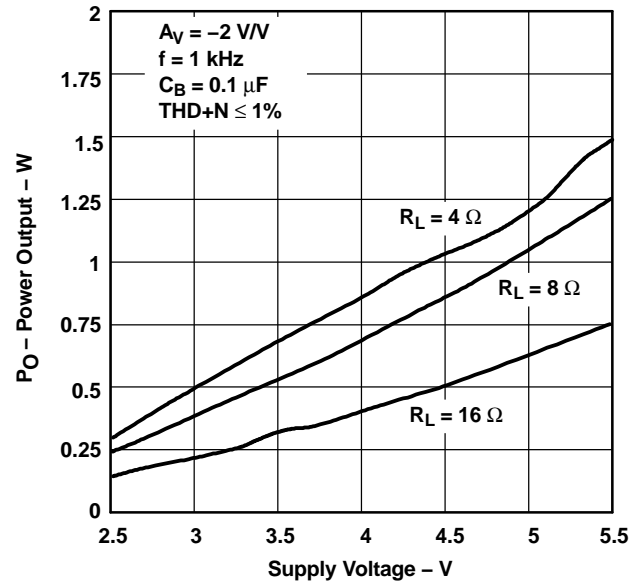

Figure 30.

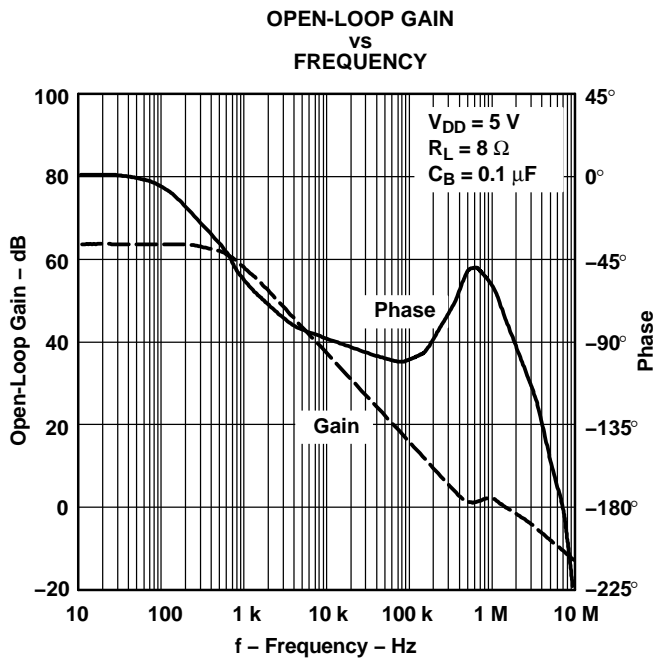

Figure 31.

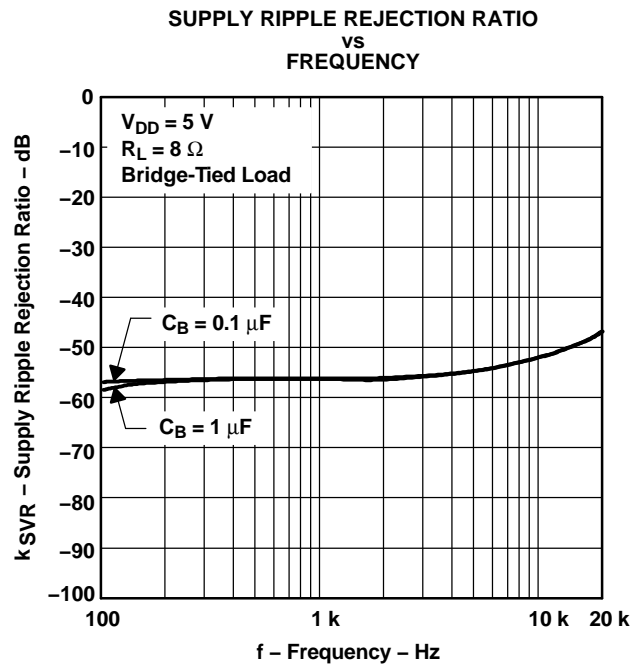

Figure 32.

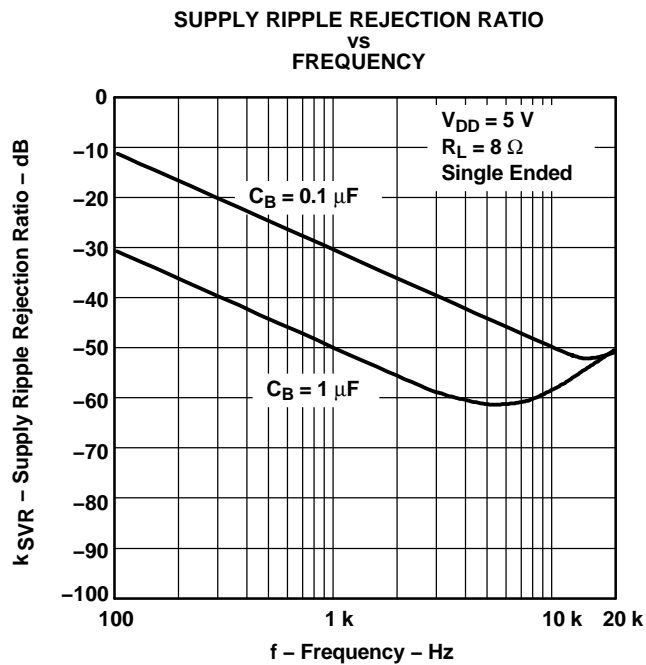

Figure 33.

APPLICATION INFORMATION

BRIDGED-TIED LOAD VERSUS SINGLE-ENDED MODE

Figure 34 shows a linear audio power amplifier (APA) in a bridge-tied load (BTL) configuration. A BTL amplifier actually consists of two linear amplifiers driving both ends of the load. There are several potential benefits to this differential drive configuration, but initially, let us consider power to the load. The differential drive to the speaker means that as one side is slewing up the other side is slewing down and vice versa. This, in effect, doubles the voltage swing on the load as compared to a ground-referenced load. Plugging twice the voltage into the power equation, where voltage is squared, yields 4 times the output power from the same supply rail and load impedance (see Equation 1).

$$V_{(rms)} = \frac{V_{O(PP)}}{2\sqrt{2}}$$

$$\text{Power} = \frac{V_{(rms)}^2}{R_L} \tag{1}$$

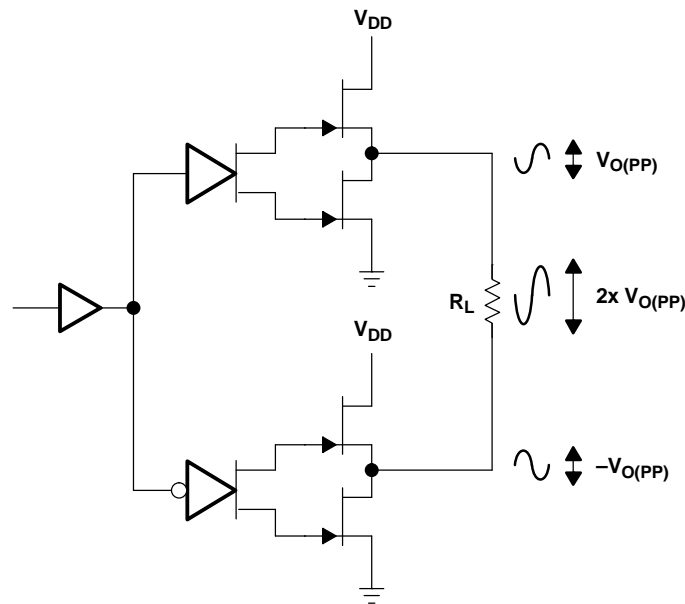

Figure 34. Bridge-Tied Load Configuration

In a typical computer sound channel operating at 5 V, bridging raises the power into an 8-Ω speaker from a singled-ended (SE) limit of 250 mW to 1 W. In sound power that is a 6-dB improvement, which is loudness that can be heard. In addition to increased power, frequency response is a concern; consider the single-supply SE configuration shown in Figure 35. A coupling capacitor is required to block the dc offset voltage from reaching the load. These capacitors can be quite large (approximately 40 μF to 1000 μF) so they tend to be expensive, occupy valuable PCB area, and have the additional drawback of limiting low-frequency performance of the system. This frequency-limiting effect is due to the high-pass filter network created with the speaker impedance and the coupling capacitance and is calculated with Equation 2.

$$f_{(\text{corner})} = \frac{1}{2\pi R_L C_C} \tag{2}$$

For example, a 68-μF capacitor with an 8-Ω speaker would attenuate low frequencies below 293 Hz. The BTL configuration cancels the dc offsets, which eliminates the need for the blocking capacitors. Low-frequency performance is then limited only by the input network and speaker response. Cost and PCB space are also minimized by eliminating the bulky coupling capacitor.

APPLICATION INFORMATION (continued)

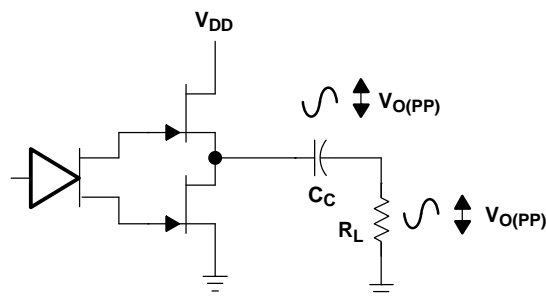

Figure 35. Single-Ended Configuration

Increasing power to the load does carry a penalty of increased internal power dissipation. The increased dissipation is understandable considering that the BTL configuration produces 4 times the output power of the SE configuration. Internal dissipation versus output power is discussed further in the *thermal considerations* section.

BTL AMPLIFIER EFFICIENCY

Linear amplifiers are notoriously inefficient. The primary cause of these inefficiencies is voltage drop across the output stage transistors. The internal voltage drop has two components. One is the headroom or dc voltage drop that varies inversely to output power. The second component is due to the sine-wave nature of the output. The total voltage drop can be calculated by subtracting the RMS value of the output voltage from V_{DD} . The internal voltage drop multiplied by the RMS value of the supply current, $I_{DD(RMS)}$, determines the internal power dissipation of the amplifier.

An easy-to-use equation to calculate efficiency starts out as being equal to the ratio of power from the power supply to the power delivered to the load. To accurately calculate the RMS values of power in the load and in the amplifier, the current and voltage waveform shapes must first be understood (see Figure 36).

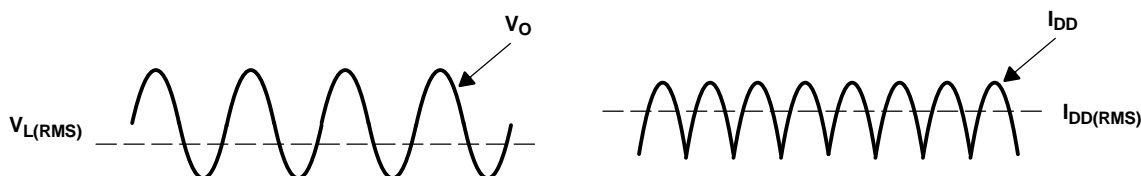

Figure 36. Voltage and Current Waveforms for BTL Amplifiers

Although the voltages and currents for SE and BTL are sinusoidal in the load, currents from the supply are different between SE and BTL configurations. In an SE application, the current waveform is a half-wave rectified shape, whereas in BTL it is a full-wave rectified waveform. This means RMS conversion factors are different. Keep in mind that for most of the waveform, both the push and pull transistor are not on at the same time, which supports the fact that each amplifier in the BTL device only draws current from the supply for half the waveform. The following equations are the basis for calculating amplifier efficiency.

APPLICATION INFORMATION (continued)

$$\text{Efficiency} = \frac{P_L}{P_{\text{SUP}}}$$

Where:

$$P_L = \frac{V_{L(\text{RMS})}^2}{R_L} = \frac{V_p^2}{2R_L}$$

$$V_{L(\text{RMS})} = \frac{V_P}{\sqrt{2}}$$

$$P_{\text{SUP}} = V_{\text{DD}} I_{\text{DD}(\text{RMS})} = \frac{V_{\text{DD}} 2V_P}{\pi R_L}$$

$$I_{\text{DD}(\text{RMS})} = \frac{2V_P}{\pi R_L}$$

(3)

$$\text{Efficiency of a BTL configuration} = \frac{\pi V_P}{2V_{\text{DD}}} = \frac{\pi \left(\frac{P_L R_L}{2} \right)^{1/2}}{2V_{\text{DD}}}$$

(4)

Table 1 employs Equation 4 to calculate efficiencies for four different output power levels. Note that the efficiency of the amplifier is quite low for lower power levels and rises sharply as power to the load is increased, resulting in a nearly flat internal power dissipation over the normal operating range. Note that the internal dissipation at full output power is less than in the half power range. Calculating the efficiency for a specific system is the key to proper power supply design. For a stereo 1-W audio system with 8-Ω loads and a 5-V supply, the maximum draw on the power supply is almost 3.25 W.

Table 1. Efficiency Vs Output Power in 5-V 8-Ω BTL Systems

OUTPUT POWER (W)	EFFICIENCY (%)	PEAK-TO-PEAK VOLTAGE (V)	INTERNAL DISSIPATION (W)
0.25	31.4	2.00	0.55
0.50	44.4	2.83	0.62
1.00	62.8	4.00	0.59
1.25	70.2	4.47 ⁽¹⁾	0.53

(1) High peak voltages cause the THD to increase.

A final point to remember about linear amplifiers, whether they are SE or BTL configured, is how to manipulate the terms in the efficiency equation to utmost advantage when possible. Note that in Equation 4, V_{DD} is in the denominator. This indicates that as V_{DD} goes down, efficiency goes up.

For example, if the 5-V supply is replaced with a 10-V supply (TPA4861 has a maximum recommended V_{DD} of 5.5 V) in the calculations of Table 1, then efficiency at 1 W would fall to 31% and internal power dissipation would rise to 2.18 W from 0.59 W at 5 V. Then for a stereo 1-W system from a 10-V supply, the maximum draw would be almost 6.5 W. Choose the correct supply voltage and speaker impedance for the application.

SELECTION OF COMPONENTS

Figure 37 is a schematic diagram of a typical notebook computer application circuit.

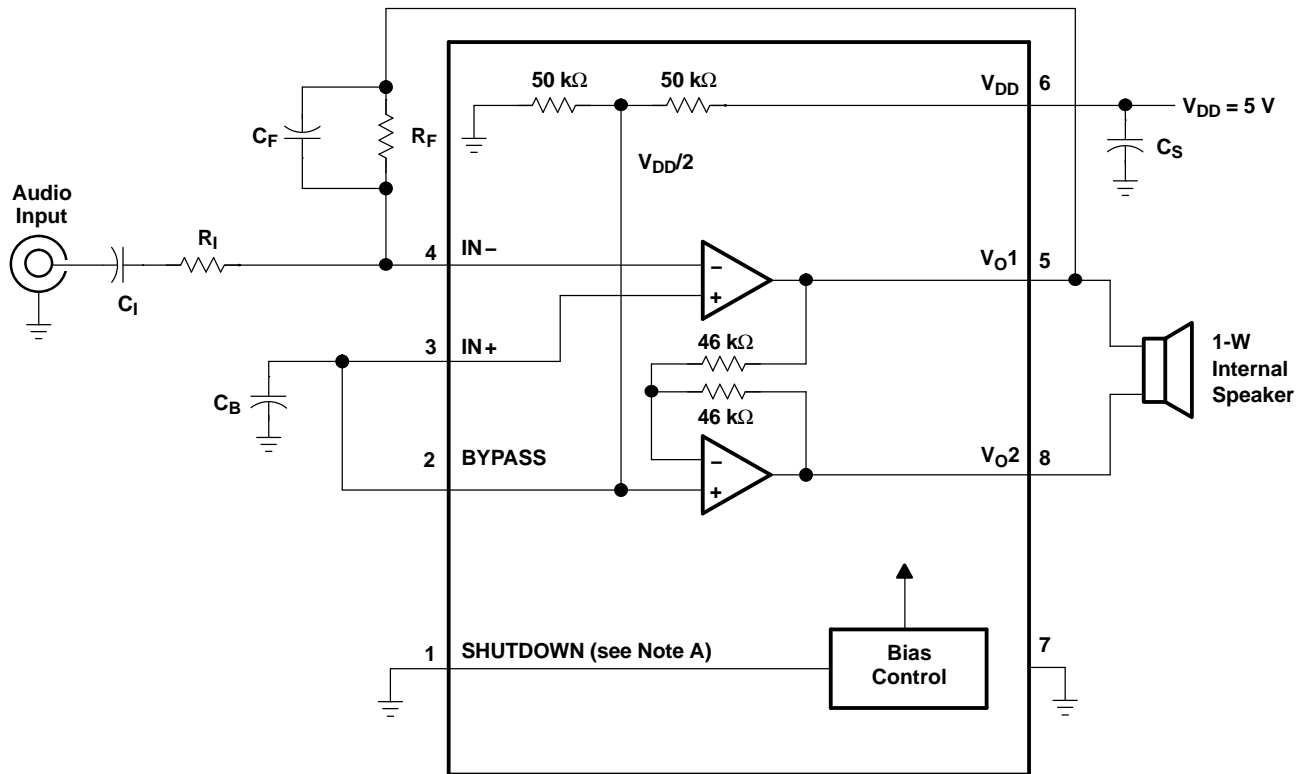

NOTE A: SHUTDOWN must be held low for normal operation and asserted high for shutdown mode.

Figure 37. TPA4861 Typical Notebook Computer Application Circuit

Gain Setting Resistors, R_F and R_I

The gain for the TPA4861 is set by resistors R_F and R_I according to Equation 5.

$$\text{Gain} = -2 \left(\frac{R_F}{R_I} \right) \tag{5}$$

BTL mode operation brings about the factor of 2 in the gain equation due to the inverting amplifier mirroring the voltage swing across the load. Given that the TPA4861 is a MOS amplifier, the input impedance is high; consequently, input leakage currents are not generally a concern, although noise in the circuit increases as the value of R_F increases. In addition, a certain range of R_F values are required for proper start-up operation of the amplifier. Taken together, it is recommended that the effective impedance seen by the inverting node of the amplifier be set between 5 kΩ and 20 kΩ. The effective impedance is calculated in Equation 6.

$$\text{Effective Impedance} = \frac{R_F R_I}{R_F + R_I} \tag{6}$$

As an example, consider an input resistance of 10 kΩ and a feedback resistor of 50 kΩ. The gain of the amplifier would be -10 V/V , and the effective impedance at the inverting terminal would be 8.3 kΩ, which is well within the recommended range.

For high-performance applications, metal film resistors are recommended because they tend to have lower noise levels than carbon resistors. For values of R_F above 50 kΩ, the amplifier tends to become unstable due to a pole formed from R_F and the inherent input capacitance of the MOS input structure. For this reason, a small compensation capacitor of approximately 5 pF should be placed in parallel with R_F . This, in effect, creates a low-pass filter network with the cutoff frequency defined in Equation 7.

$$f_{co(\text{lowpass})} = \frac{1}{2\pi R_F C_F} \quad (7)$$

For example if R_F is 100 k Ω and C_F is 5 pF, then f_{co} is 318 kHz, which is well outside of the audio range.

Input Capacitor, C_I

In the typical application, an input capacitor, C_I , is required to allow the amplifier to bias the input signal to the proper dc level for optimum operation. In this case, C_I and R_I form a high-pass filter with the corner frequency determined in Equation 8.

$$f_{co(\text{highpass})} = \frac{1}{2\pi R_I C_I} \quad (8)$$

The value of C_I is important to consider, as it directly affects the bass (low-frequency) performance of the circuit. Consider the example where R_I is 10 k Ω and the specification calls for a flat bass response down to 40 Hz. Equation 8 is reconfigured as Equation 9.

$$C_I = \frac{1}{2\pi R_I f_{co}} \quad (9)$$

In this example, C_I is 0.40 μF ; so, one would likely choose a value in the range of 0.47 μF to 1 μF . A further consideration for this capacitor is the leakage path from the input source through the input network (R_I , C_I) and the feedback resistor (R_F) to the load. This leakage current creates a dc offset voltage at the input to the amplifier that reduces useful headroom, especially in high-gain applications. For this reason a low-leakage tantalum or ceramic capacitor is the best choice. When polarized capacitors are used, the positive side of the capacitor should face the amplifier input in most applications as the dc level there is held at $V_{DD}/2$, which is likely higher than the source dc level. Note that it is important to confirm the capacitor polarity in the application.

Power Supply Decoupling, C_S

The TPA4861 is a high-performance CMOS audio amplifier that requires adequate power supply decoupling to ensure that the output total harmonic distortion (THD) is as low as possible. Power supply decoupling also prevents oscillations for long lead lengths between the amplifier and the speaker. The optimum decoupling is achieved by using two capacitors of different types that target different types of noise on the power supply leads. For higher frequency transients, spikes, or digital hash on the line, a good low equivalent-series-resistance (ESR) ceramic capacitor, typically 0.1 μF placed as close as possible to the device V_{DD} lead, works best. For filtering lower-frequency noise signals, a larger aluminum electrolytic capacitor of 10 μF or greater placed near the power amplifier is recommended.

Midrail Bypass Capacitor, C_B

The midrail bypass capacitor, C_B , serves several important functions. During start-up or recovery from shutdown mode, C_B determines the rate at which the amplifier starts up. This helps to push the start-up pop noise into the subaudible range (so slow it cannot be heard). The second function is to reduce noise produced by the power supply caused by coupling into the output drive signal. This noise is from the midrail generation circuit internal to the amplifier. The capacitor is fed from a 25-k Ω source inside the amplifier. To keep the start-up pop as low as possible, the relationship shown in Equation 10 should be maintained.

$$\frac{1}{(C_B \times 25 \text{ k}\Omega)} \leq \frac{1}{(C_I R_I)} \quad (10)$$

As an example, consider a circuit where C_B is 0.1 μF , C_I is 0.22 μF and R_I is 10 k Ω . Inserting these values into the Equation 10, we get $400 \leq 454$ which satisfies the rule. Bypass capacitor, C_B , values of 0.1- μF to 1- μF ceramic or tantalum low-ESR capacitors are recommended for the best THD and noise performance.

SINGLE-ENDED OPERATION

Figure 38 is a schematic diagram of the recommended SE configuration. In SE mode configurations, the load should be driven from the primary amplifier output (V_{O1}, terminal 5).

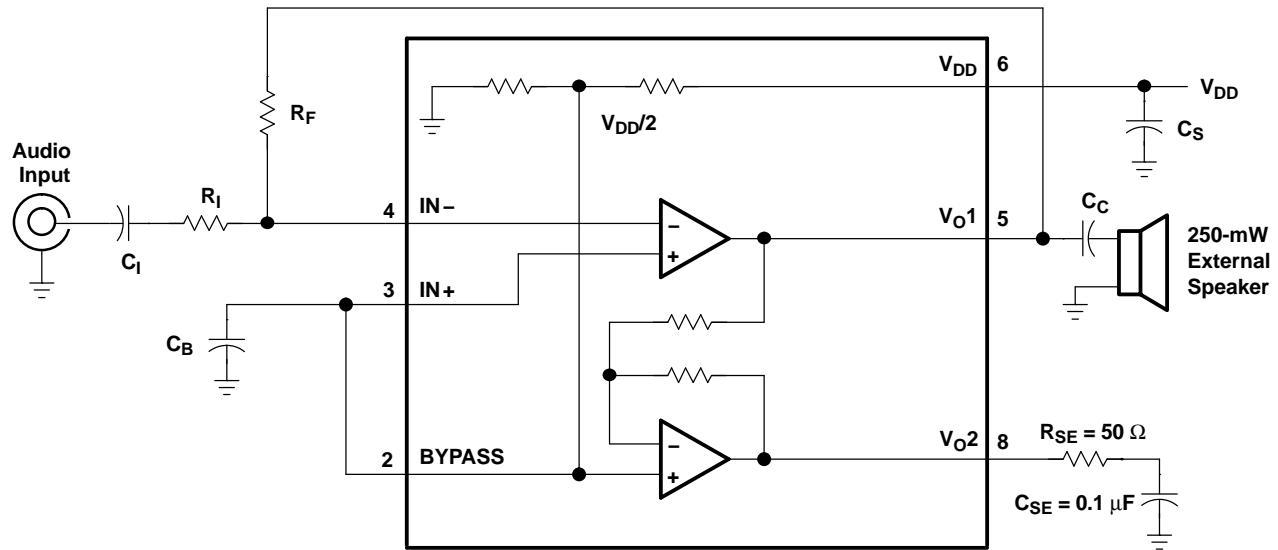

Figure 38. Singled-Ended Mode

Gain is set by the R_F and R_I resistors and is shown in Equation 11. Because the inverting amplifier is not used to mirror the voltage swing on the load, the factor of 2 is not included.

$$\text{Gain} = - \left(\frac{R_F}{R_I} \right) \tag{11}$$

The phase margin of the inverting amplifier into an open circuit is not adequate to ensure stability, so a termination load should be connected to V_{O2}. This consists of a 50-Ω resistor in series with a 0.1-μF capacitor to ground. It is important to avoid oscillation of the inverting output to minimize noise and power dissipation.

The output coupling capacitor required in single-supply SE mode also places additional constraints on the selection of other components in the amplifier circuit. The rules described earlier still hold with the addition of the following relationship:

$$\frac{1}{(C_B \times 25 \text{ k}\Omega)} \leq \frac{1}{(C_I R_I)} \ll \frac{1}{R_L C_C} \tag{12}$$

OUTPUT COUPLING CAPACITOR, C_C

In the typical single-supply SE configuration, an output coupling capacitor (C_C) is required to block the dc bias at the output of the amplifier thus preventing dc currents in the load. As with the input coupling capacitor, the output coupling capacitor and impedance of the load form a high-pass filter governed by Equation 13.

$$f_{\text{out high}} = \frac{1}{2\pi R_L C_C} \tag{13}$$

The main disadvantage, from a performance standpoint, is that the load impedances are typically small, which drives the low-frequency corner higher. Large values of C_C are required to pass low frequencies into the load. Consider the example where a C_C of 68 μF is chosen and loads vary from 8 Ω, 32 Ω, and 47 kΩ. Table 2 summarizes the frequency response characteristics of each configuration.

Table 2. Common Load Impedances vs Low-Frequency Output Characteristics in SE Mode

R_L	C_C	LOWEST FREQUENCY
8 Ω	68 μ F	293 Hz
32 Ω	68 μ F	73 Hz
47,000 Ω	68 μ F	0.05 Hz

As Table 2 indicates, most of the bass response is attenuated into 8- Ω loads, while headphone response is adequate and drive into line level inputs (a home stereo for example) is good.

SHUTDOWN MODE

The TPA4861 employs a shutdown mode of operation designed to reduce supply current, $I_{DD(q)}$, to the absolute minimum level during periods of nonuse for battery-power conservation. For example, during device sleep modes or when other audio-drive currents are used (i.e., headphone mode), the speaker drive is not required. The SHUTDOWN input terminal should be held low during normal operation when the amplifier is in use. Pulling SHUTDOWN high causes the outputs to mute and the amplifier to enter a low-current state, $I_{DD(SD)} \sim 0.6 \mu$ A. SHUTDOWN should never be left unconnected because amplifier operation would be unpredictable.

USING LOW-ESR CAPACITORS

Low-ESR capacitors are recommended throughout this applications section. A real capacitor can be modeled simply as a resistor in series with an ideal capacitor. The voltage drop across this resistor minimizes the beneficial effects of the capacitor in the circuit. The lower the equivalent value of this resistance, the more the real capacitor behaves like an ideal capacitor.

THERMAL CONSIDERATIONS

A prime consideration when designing an audio amplifier circuit is internal power dissipation in the device. The curve in Figure 39 provides an easy way to determine what output power can be expected out of the TPA4861 for a given system ambient temperature in designs using 5-V supplies. This curve assumes no forced airflow or additional heat sinking.

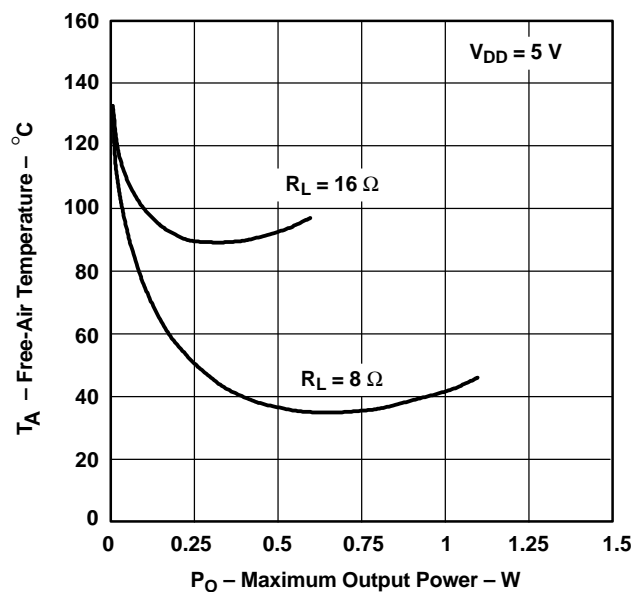

Figure 39. Free-Air Temperature vs Maximum Continuous Output Power

5-V VERSUS 3.3-V OPERATION

The TPA4861 was designed for operation over a supply range of 2.7 V to 5.5 V. This data sheet provides full specifications for 5-V and 3.3-V operation, as these are considered to be the two most common standard voltages. There are no special considerations for 3.3-V versus 5-V operation as far as supply bypassing, gain setting, or stability. Supply current is slightly reduced from 3.5 mA (typical) to 2.5 mA (typical). The most important consideration is that of output power. Each amplifier in TPA4861 can produce a maximum voltage swing of $V_{DD} - 1$ V. This means, for 3.3-V operation, clipping starts to occur when $V_{O(PP)} = 2.3$ V as opposed to when $V_{O(PP)} = 4$ V while operating at 5 V. The reduced voltage swing subsequently reduces maximum output power into an 8- Ω load to less than 0.33 W before distortion begins to become significant.

Operation at 3.3-V supplies, as can be shown from the efficiency formula in Equation 4, consumes approximately two-thirds of the supply power for a given output-power level than operation from 5-V supplies. When the application demands less than 500 mW, 3.3-V operation should be strongly considered, especially in battery-powered applications.

PACKAGING INFORMATION

Orderable Device	Status ⁽¹⁾	Package Type	Package Drawing	Pins	Package Qty	Eco Plan ⁽²⁾	Lead/Ball Finish	MSL Peak Temp ⁽³⁾
TPA4861D	ACTIVE	SOIC	D	8	75	Green (RoHS & no Sb/Br)	CU NIPDAU	Level-1-260C-UNLIM
TPA4861DG4	ACTIVE	SOIC	D	8	75	Green (RoHS & no Sb/Br)	CU NIPDAU	Level-1-260C-UNLIM
TPA4861DR	ACTIVE	SOIC	D	8	2500	Green (RoHS & no Sb/Br)	CU NIPDAU	Level-1-260C-UNLIM
TPA4861DRG4	ACTIVE	SOIC	D	8	2500	Green (RoHS & no Sb/Br)	CU NIPDAU	Level-1-260C-UNLIM

⁽¹⁾ The marketing status values are defined as follows:

ACTIVE: Product device recommended for new designs.

LIFEBUY: TI has announced that the device will be discontinued, and a lifetime-buy period is in effect.

NRND: Not recommended for new designs. Device is in production to support existing customers, but TI does not recommend using this part in a new design.

PREVIEW: Device has been announced but is not in production. Samples may or may not be available.

OBSOLETE: TI has discontinued the production of the device.

⁽²⁾ Eco Plan - The planned eco-friendly classification: Pb-Free (RoHS), Pb-Free (RoHS Exempt), or Green (RoHS & no Sb/Br) - please check <http://www.ti.com/productcontent> for the latest availability information and additional product content details.

TBD: The Pb-Free/Green conversion plan has not been defined.

Pb-Free (RoHS): TI's terms "Lead-Free" or "Pb-Free" mean semiconductor products that are compatible with the current RoHS requirements for all 6 substances, including the requirement that lead not exceed 0.1% by weight in homogeneous materials. Where designed to be soldered at high temperatures, TI Pb-Free products are suitable for use in specified lead-free processes.

Pb-Free (RoHS Exempt): This component has a RoHS exemption for either 1) lead-based flip-chip solder bumps used between the die and package, or 2) lead-based die adhesive used between the die and leadframe. The component is otherwise considered Pb-Free (RoHS compatible) as defined above.

Green (RoHS & no Sb/Br): TI defines "Green" to mean Pb-Free (RoHS compatible), and free of Bromine (Br) and Antimony (Sb) based flame retardants (Br or Sb do not exceed 0.1% by weight in homogeneous material)

⁽³⁾ MSL, Peak Temp. -- The Moisture Sensitivity Level rating according to the JEDEC industry standard classifications, and peak solder temperature.

Important Information and Disclaimer:The information provided on this page represents TI's knowledge and belief as of the date that it is provided. TI bases its knowledge and belief on information provided by third parties, and makes no representation or warranty as to the accuracy of such information. Efforts are underway to better integrate information from third parties. TI has taken and continues to take reasonable steps to provide representative and accurate information but may not have conducted destructive testing or chemical analysis on incoming materials and chemicals. TI and TI suppliers consider certain information to be proprietary, and thus CAS numbers and other limited information may not be available for release.



In no event shall TI's liability arising out of such information exceed the total purchase price of the TI part(s) at issue in this document sold by TI to Customer on an annual basis.

MECHANICAL DATA

D (R-PDSO-G8)

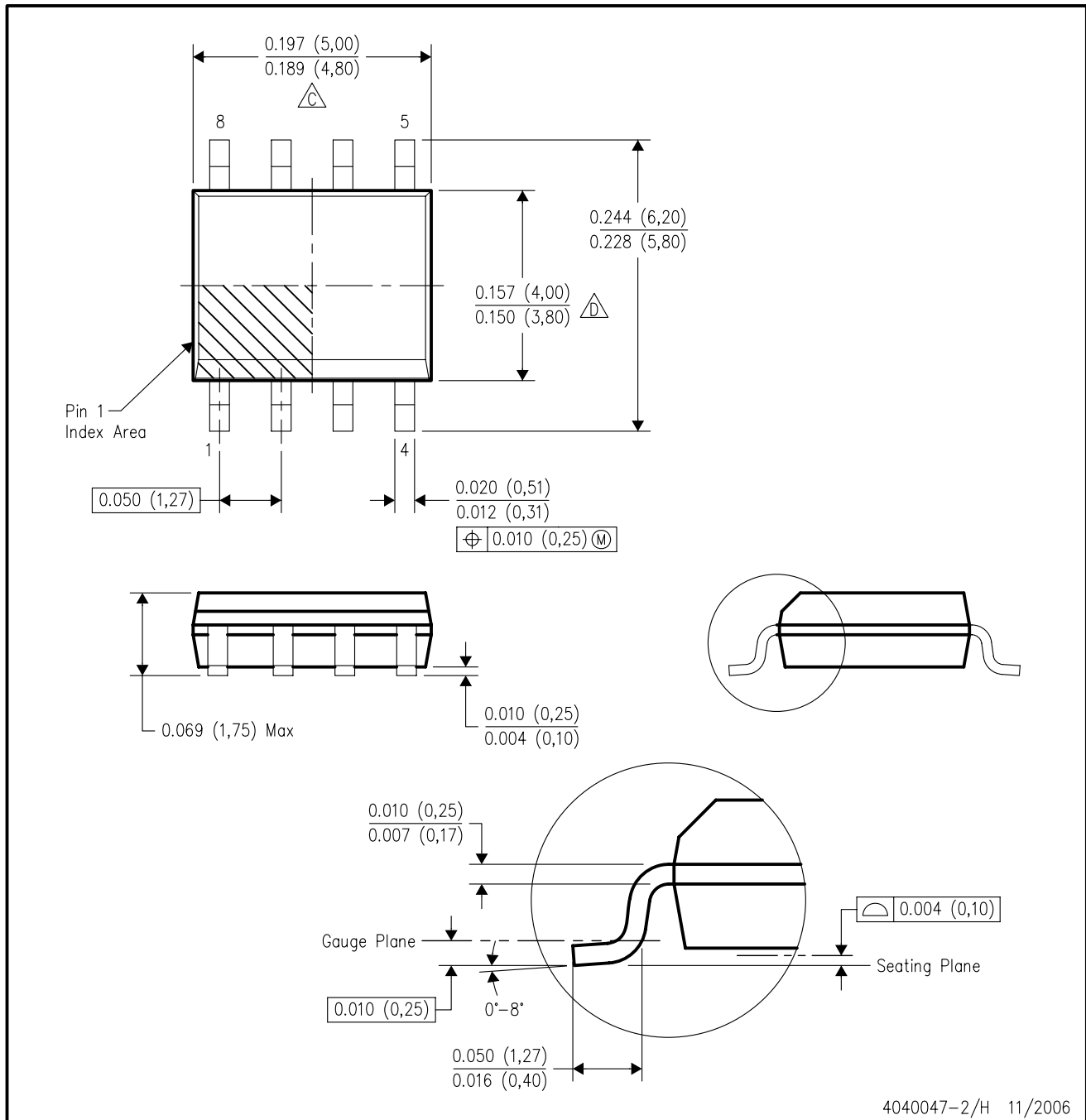
PLASTIC SMALL-OUTLINE PACKAGE



- NOTES:
- A. All linear dimensions are in inches (millimeters).
 - B. This drawing is subject to change without notice.
 -  Body length does not include mold flash, protrusions, or gate burrs. Mold flash, protrusions, or gate burrs shall not exceed .006 (0,15) per end.
 -  Body width does not include interlead flash. Interlead flash shall not exceed .017 (0,43) per side.
 - E. Reference JEDEC MS-012 variation AA.

IMPORTANT NOTICE

Texas Instruments Incorporated and its subsidiaries (TI) reserve the right to make corrections, modifications, enhancements, improvements, and other changes to its products and services at any time and to discontinue any product or service without notice. Customers should obtain the latest relevant information before placing orders and should verify that such information is current and complete. All products are sold subject to TI's terms and conditions of sale supplied at the time of order acknowledgment.

TI warrants performance of its hardware products to the specifications applicable at the time of sale in accordance with TI's standard warranty. Testing and other quality control techniques are used to the extent TI deems necessary to support this warranty. Except where mandated by government requirements, testing of all parameters of each product is not necessarily performed.

TI assumes no liability for applications assistance or customer product design. Customers are responsible for their products and applications using TI components. To minimize the risks associated with customer products and applications, customers should provide adequate design and operating safeguards.

TI does not warrant or represent that any license, either express or implied, is granted under any TI patent right, copyright, mask work right, or other TI intellectual property right relating to any combination, machine, or process in which TI products or services are used. Information published by TI regarding third-party products or services does not constitute a license from TI to use such products or services or a warranty or endorsement thereof. Use of such information may require a license from a third party under the patents or other intellectual property of the third party, or a license from TI under the patents or other intellectual property of TI.

Reproduction of information in TI data books or data sheets is permissible only if reproduction is without alteration and is accompanied by all associated warranties, conditions, limitations, and notices. Reproduction of this information with alteration is an unfair and deceptive business practice. TI is not responsible or liable for such altered documentation.

Resale of TI products or services with statements different from or beyond the parameters stated by TI for that product or service voids all express and any implied warranties for the associated TI product or service and is an unfair and deceptive business practice. TI is not responsible or liable for any such statements.

Following are URLs where you can obtain information on other Texas Instruments products and application solutions:

Products

Amplifiers	amplifier.ti.com
Data Converters	dataconverter.ti.com
DSP	dsp.ti.com
Interface	interface.ti.com
Logic	logic.ti.com
Power Mgmt	power.ti.com
Microcontrollers	microcontroller.ti.com
Low Power Wireless	www.ti.com/lpw

Applications

Audio	www.ti.com/audio
Automotive	www.ti.com/automotive
Broadband	www.ti.com/broadband
Digital Control	www.ti.com/digitalcontrol
Military	www.ti.com/military
Optical Networking	www.ti.com/opticalnetwork
Security	www.ti.com/security
Telephony	www.ti.com/telephony
Video & Imaging	www.ti.com/video
Wireless	www.ti.com/wireless

Mailing Address: Texas Instruments
Post Office Box 655303 Dallas, Texas 75265