

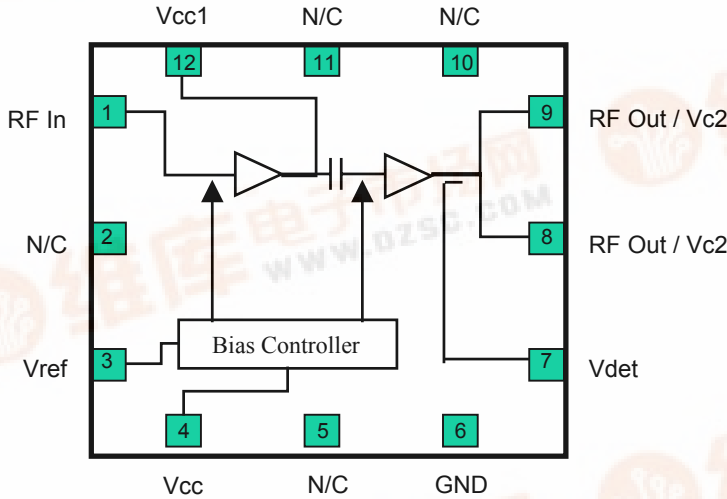

TQP2420B PRELIMINARY DATASHEET



Product Description:

The TQP2420B is a linear, high performance, medium-power amplifier designed for 802.11b WLAN and other applications in the 2.4GHz ISM band. The device exhibits industry-leading power added efficiency under 802.11b CCK modulation while meeting ACP requirements. The power amplifier is manufactured using TriQuint's InGaP HBT process and is packaged in an industry standard 3mm x 3mm VQFN-12 package.

Selected Electrical Specifications:

Parameter	min	typ	max	units
Frequency Range	2400	-	2500	MHz
Linear Output Power (guaranteed ACP under 802.11b modulation)	22	23		dBm
Power Gain (Pin = -6 dBm)	28	28.8	31	dB
Power Added Efficiency		35		%
802.11b ACP; +22.0 dBm Output; 1 st Side Lobe		-35		dBc
802.11b ACP; +22.0 dBm Output; 2 nd Side Lobe		-56		dBc

Test Conditions: $T_a=25^{\circ}\text{C}$; $V_{ref}=2.95\text{V}$; $V_{cc}=V_{c1}=V_{c2}=3.3\text{V}$; 802.11b modulation

2.4GHz ISM Band InGaP HBT Power Amplifier

Features

- High-Efficiency, 2.4 GHz ISM Band PA for 802.11b WLAN Systems
- Integrated Output Power Detector
- Leadless 3.0 x 3.0 mm SMT Package
- Temperature Compensated Bias Network with Bias Shutdown Mode
- +23 dBm Linear Output Power

Applications

- 802.11b WLAN
- 2.4GHz ISM Band Applications
- Cordless Phones
- Broadband Systems

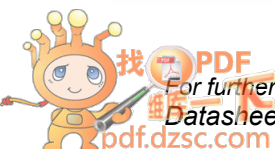

TQP2420B

Preliminary Datasheet

Absolute Maximum Ratings

Parameter	Symbol	Value		Unit
		min	max	
Power Supply Voltage (no RF applied)	Vc1, Vc2, Vcc		6.0	V
Power Supply Voltage (RF applied)	Vc1, Vc2, Vcc		5.0	V
Reference Voltage	Vref		3.0	V
Power Dissipation	Pdiss			W
Case Temperature, Survival	Tc	-40	100	°C
Storage Temperature	Ta	-40	150	°C
Operating Temperature Range	Tope	-40	85	°C
RF Input Power	Pin		+5dBm	dBm

General Electrical Characteristics^{1,2}

Parameter	min	typ	max	Unit
Frequency Range	2400	-	2500	Mhz
Output Power @ 1dB Gain Compression		24		dBm
Linear Output Power (guaranteed ACP under 802.11b modulation)	22	23		dBm
Power Gain (Pin=-6dBm)	28	28.8	31	dB
Gain Variation vs. Frequency		0.4		dB p-p
Power Added Efficiency		35		%
802.11b Adjacent Channel Power @ +22.0 dBm Output power - 1 st Side Lobe		-35		dBc
802.11b Adjacent Channel Power @ +22.0 dBm Output power - 2 nd Side Lobe		-56		dBc
Input VSWR with external matching)			2:1	

¹Test Conditions: $T_a=25^{\circ}C$, $V_{ref}=2.95V$, $V_{cc}=V_{c1}=V_{c2}=3.3V$ 802.11b modulation

²AC performance is guaranteed at 25 Deg-C, $V_{cc}=V_{c1}=V_{c2}=3.3V$, $V_{ref}=2.95V$

DC Electrical Performance* At Vref=2.95V typical

Parameter,	min	typ	max	Unit
Operating Voltage Supply Range	3.0	3.3	3.6	V
Supply Current: $T_a = 25^{\circ}C$, $V_{cc}=V_{ref}=2.95$ $V_{c1}=V_{c2}= 3.3V$ Linear Output Power = 22dBm, with 802.11b CCK modulation		160		mA
Vref	2.85	2.95	3.0	
Ivref		2		mA
Shutdown Mode Current		<1		uA
Quiescent current*		60		mA

Schematic

TL13	3.5 Deg
TL6	23.8 Deg
TL11	2.8 Deg
TL3	2.8 Deg
TL1	14.0 Deg
TL 5	18.2 Deg

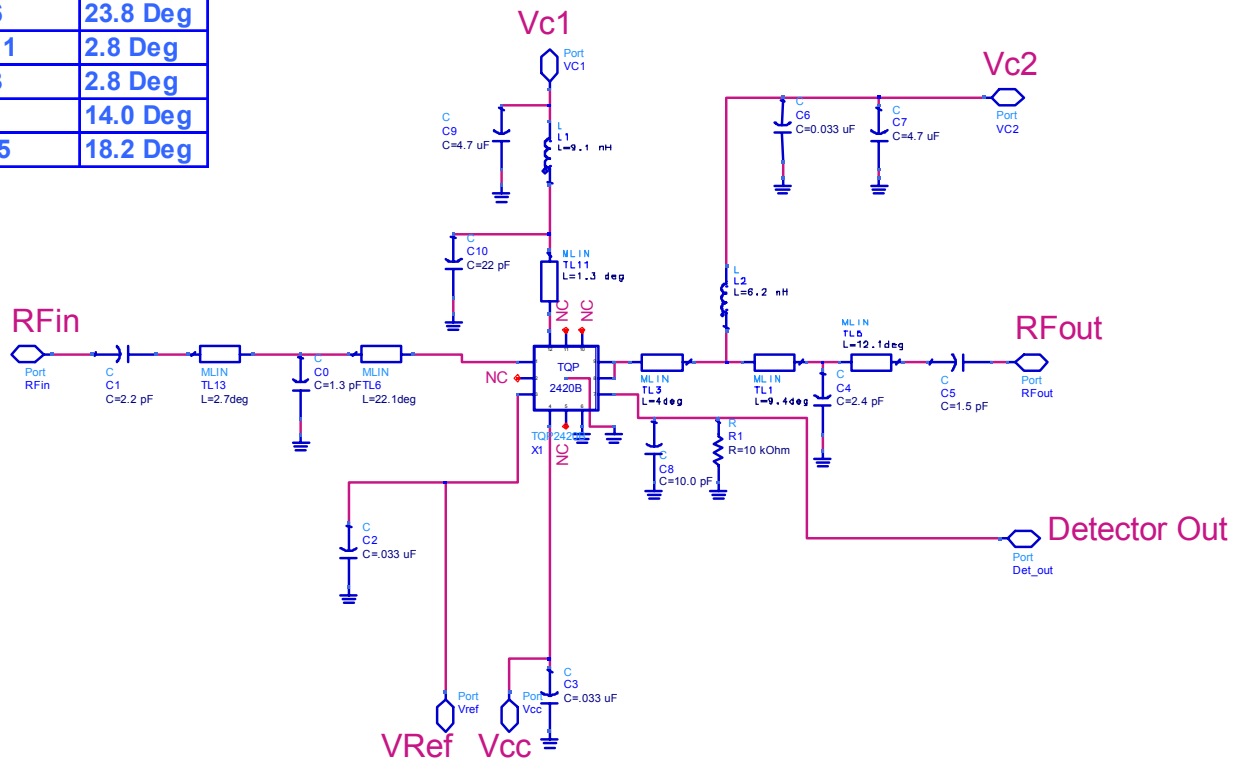

Pin Assignments

Pin	Symbol	Description
1	RFIn	RF Input
2	N/C	
3	Vref	Bias Reference voltage
4	Vcc*	Bias circuit supply voltage,
5	N/C	
6	GND	Ground
7	Vdet	Power detector output voltage
8	RFout, Vcc2	RF Output and 2 nd stage collector supply voltage
9	RFout, Vcc2	RF Output and 2 nd stage collector supply voltage
10	N/C	
11	N/C	
12	Vcc1	1 st stage collector supply voltage
	GND	Backside Paddle

*Vcc may be connected directly to Vc1 or Vc2 on DC side of RF Choke

TQP2420B

Preliminary Datasheet

Evaluation Board-WLAN PA; 242x Evaluation board

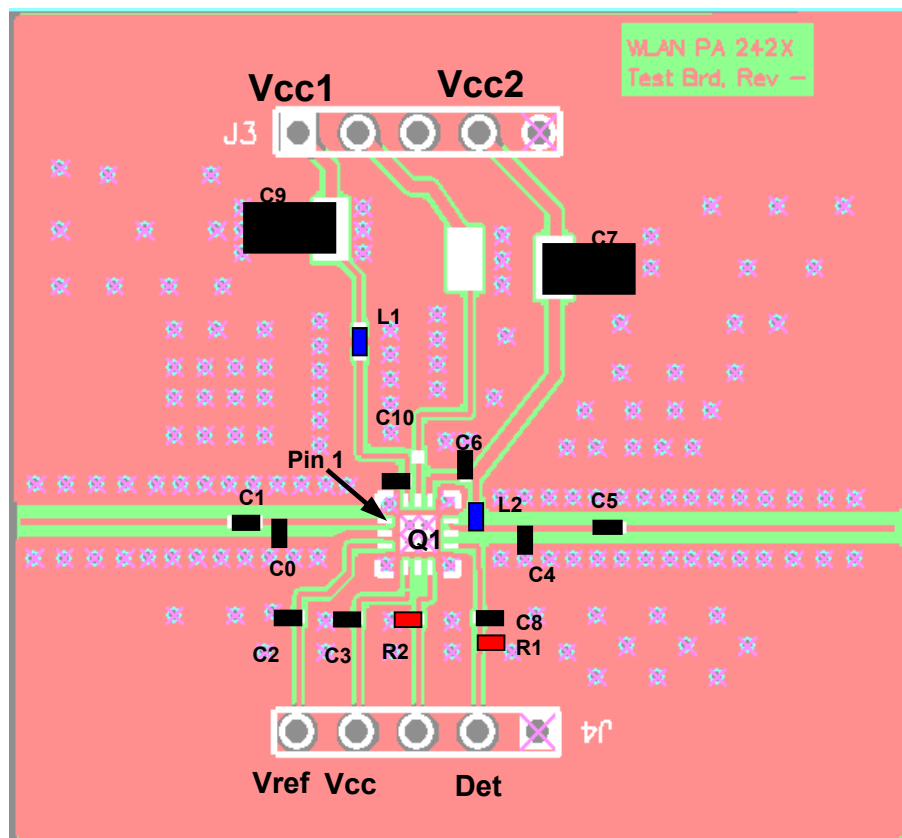

Layer/Descriptions
 Dielectric: FR4: Er=4.6
 Top: 1 oz. Plated Copper
 Dielectric 1 : 6 mils
 Mid 1: 1 oz. Copper
 Dielectric 2: 28 mils
 Mid 2: 1 oz. Copper
 Dielectric 3: 6 mils
 Bottom: 1 oz. Plated Copper

Bill of Materials

Evaluation Board			242X					
Integrated Circuit ID			TQP2420					
Part #	Quantity	Component ID	Size	Value	Units	Manufacturer	P/N	Comments
1	1	C0	0402	1.3	pF	AVX	04023J1R3BBW	
2	1	C5	0402	1.5	pF	AVX	04023J1R5BBW	
3	1	C1	0402	2.2	pF	AVX	04023J2R2BBWTR	
4	2	C3,C6	0402	0.033	uF	Murata	GRP155R71A333KA01B	
5	1	C4	0402	2.40	pF	AVX	04023J2R4BBW	
6	2	C7,C9	.130x.070	4.70	uF	AVX	TRJR475M016R	
7	1	C10	0402	22.00	pF	Murata	GRP1555C1H220JZ01B	
8	1	R1	0402	10000.00	ohms	Rhom	MCR01J133	
9	1	R2	0402	0.00	ohms	Rhom		
10	1	L1	0402	9.10	nH	Murata	LQW15AN9N1H	
11	1	L2	0402	6.20	nH	Murata	LQW15AN6N2C	
12	2	C8,C2	0402	10.00	pF	Murata	GRP1555C1H100JZ01B	
13	1	Q1	MLF		N/A	Triquint	TQP2420B	
14	2	J1,J2				Johnson	142-0711-881	
15	2	J3,J4						DC Connector
16	1	PCB					242X	Printed circuit board

TQP2420B

Preliminary Datasheet

TQP2420B measured performance; in TriQuint WLAN242X Evaluation Board

Measurement conditions $T_a = 25^\circ\text{C}$, $V_{ref}=2.95$ $V_{cc}=V_{c1}=V_{c2}= 3.3\text{V}$, Sample size 9 Units

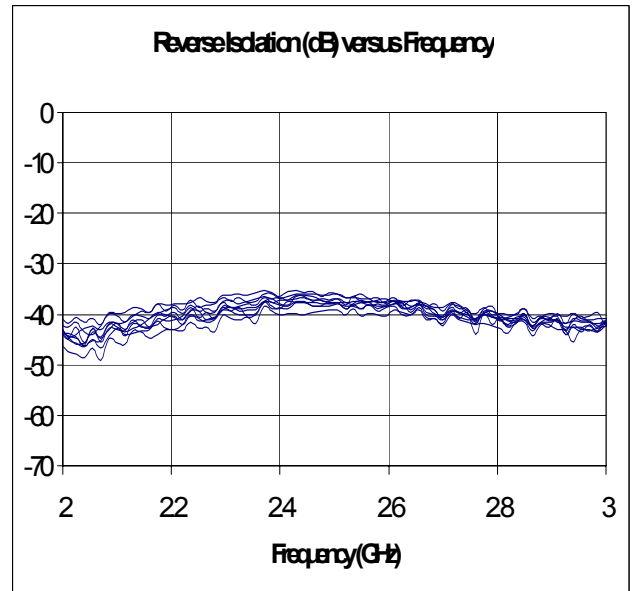
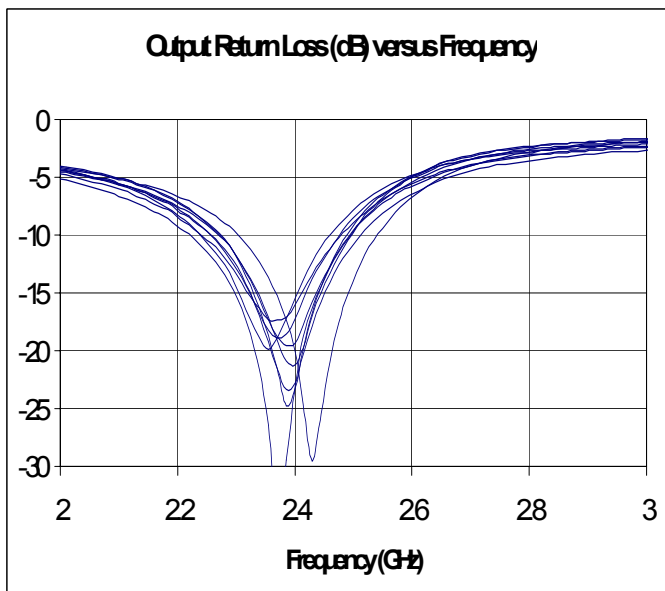
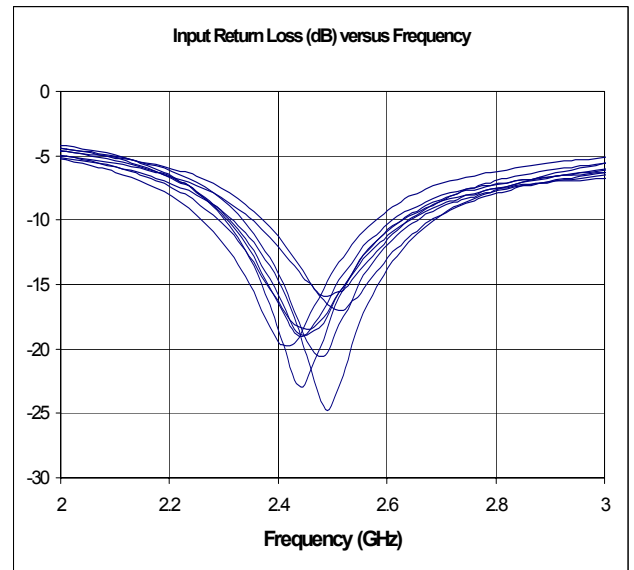
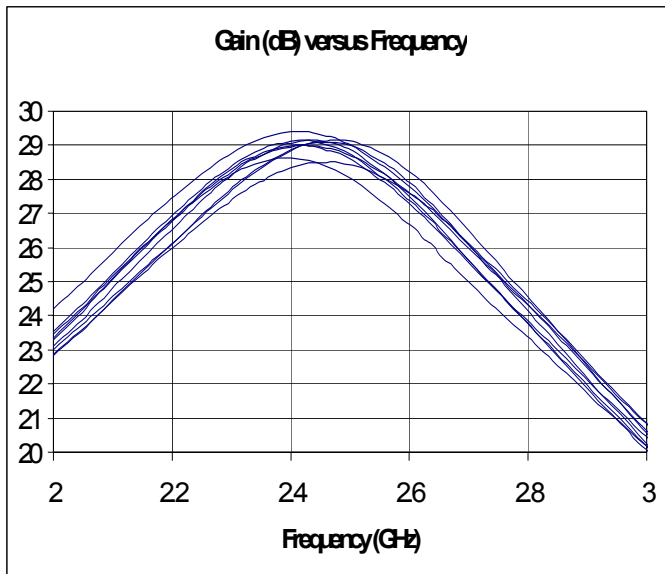

TQP2420B

Preliminary Datasheet

TQP2420B measured performance; in TriQuint WLAN242X Evaluation Board

Measurement conditions $T_a = 25^\circ\text{C}$, $V_{ref}=2.95$, $V_{cc}=V_{c1}=V_{c2}= 3.3\text{V}$, 802.11b Modulation

Transmit Spectral Mask-Typical performance

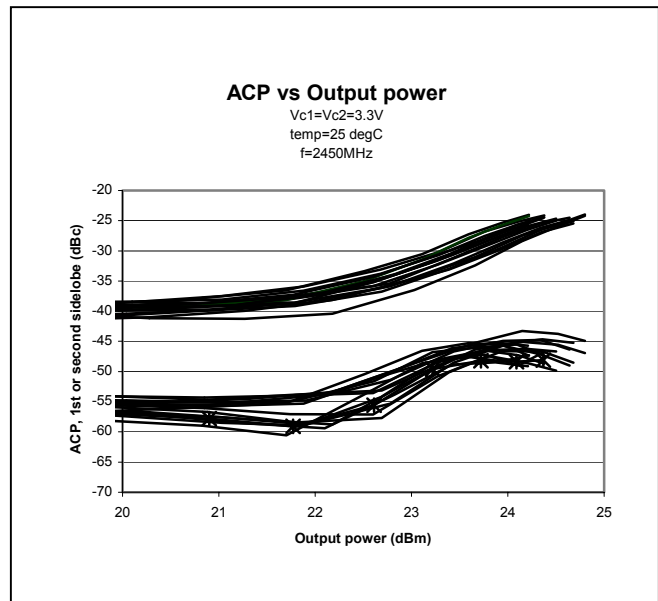
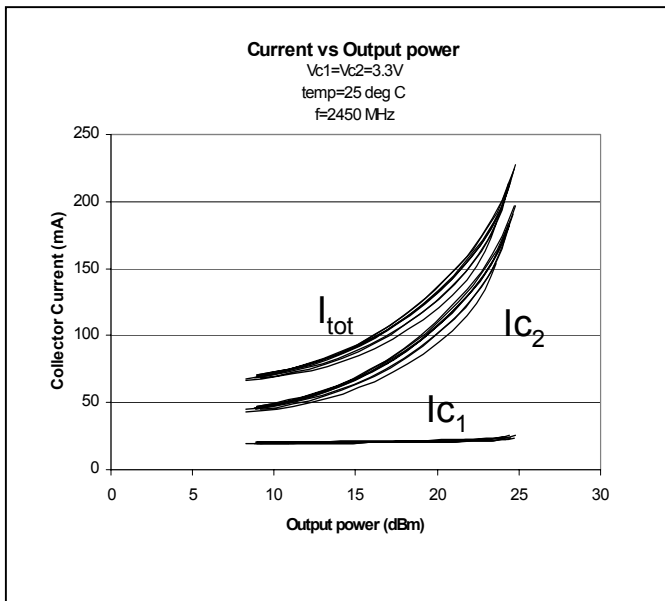
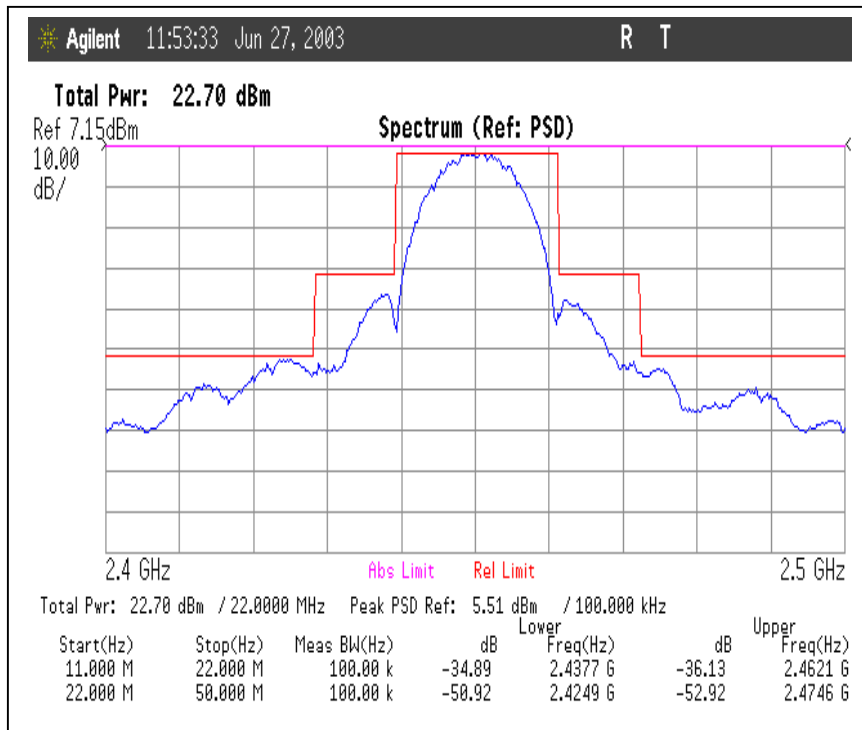

TQP2420B measured performance; in TriQuint WLAN242X Evaluation Board- Continued

Measurement conditions $T_a = 25^\circ\text{C}$, $V_{ref}=2.9$, $V_{cc}=V_{c1}=V_{c2}= 3.3\text{V}$

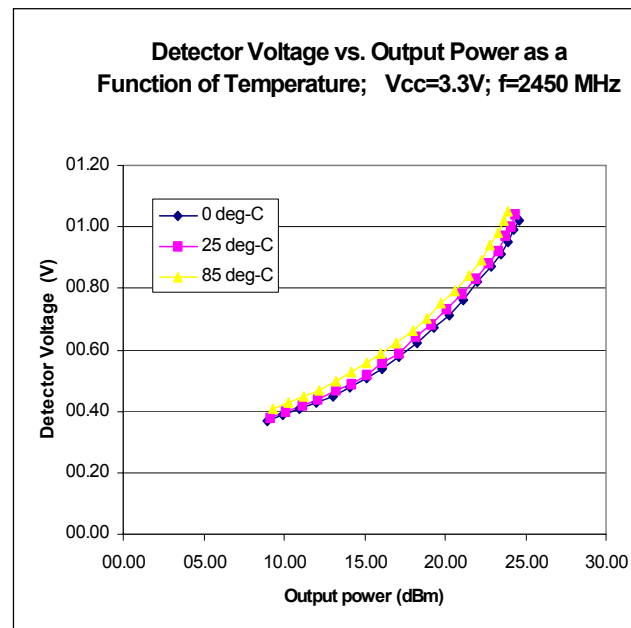
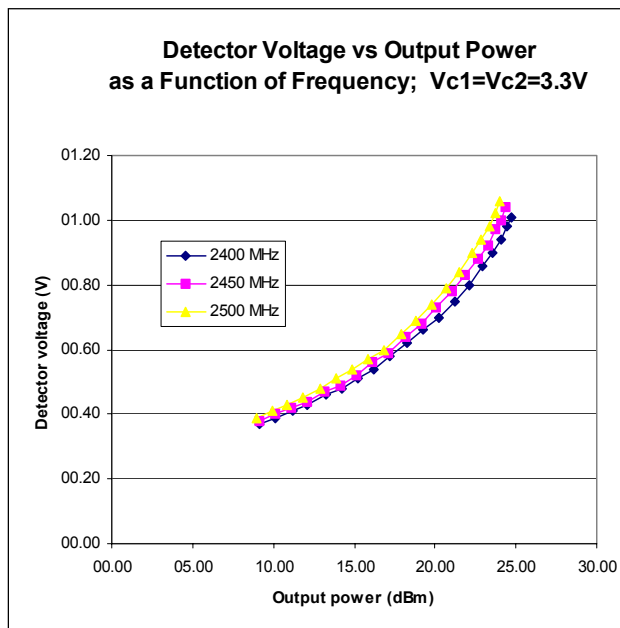
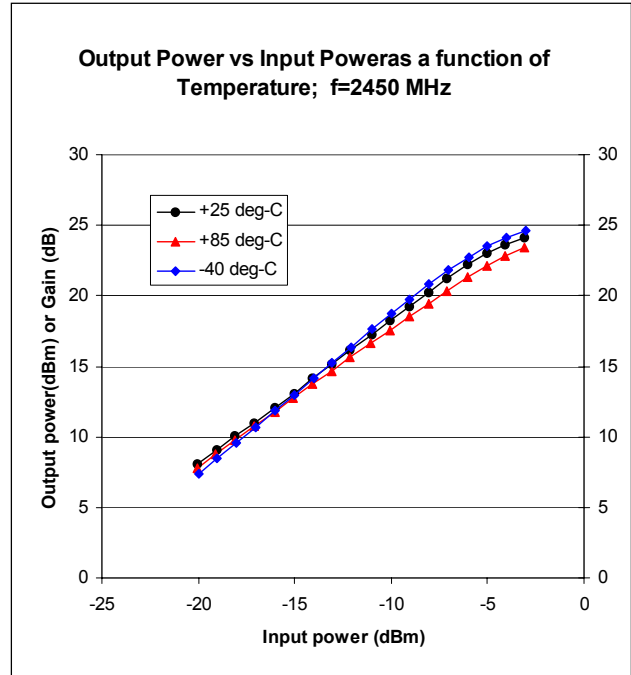
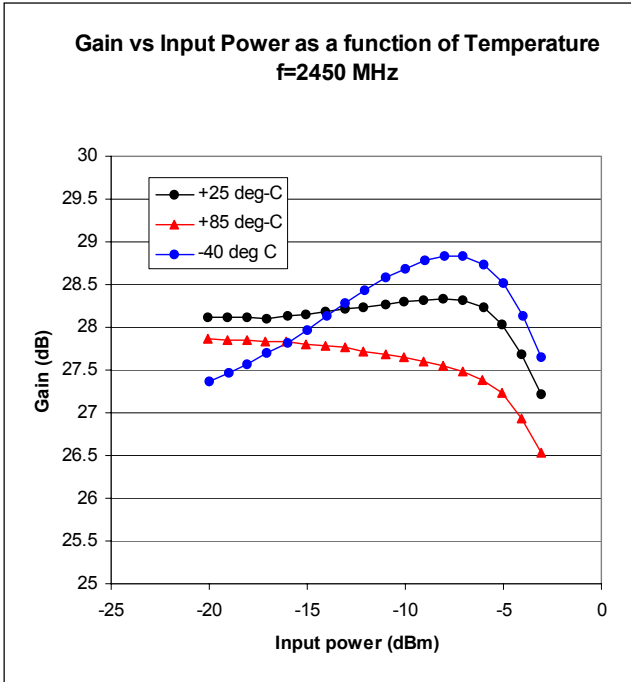

TQP2420B

Preliminary Datasheet

Application Data

External matching

•The 50 Ohm match of the input and output ports of the TQP2420B is completed by the addition of a small number of external components. The optimum impedance presented to the respective ports is described in the Smith Chart plot at the right.

•The impedance shown can be achieved by a number of topologies. The preferred topology selected for Triquint 242x evaluation board is shown in the schematic.

Source

m1
freq=2.480GHz
S(2,2)=0.750 / 177.603
impedance = $Z_0 * (0.143 + j0.020)$

Load

m2
freq=2.480GHz
S(1,1)=0.739 / -168.987
impedance = $Z_0 * (0.151 - j0.094)$

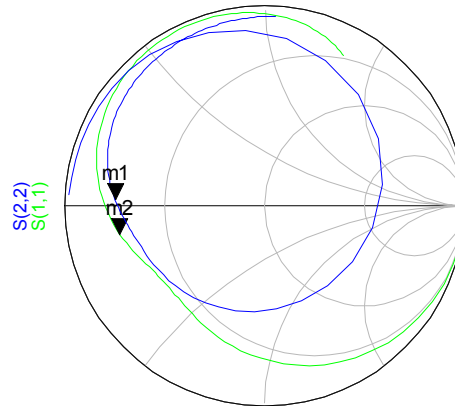

freq (30.00MHz to 6.000GHz)

Source

freq	S(1,1)
30.00MHz	0.999 / -3.957
230.0MHz	0.967 / -29.806
430.0MHz	0.903 / -53.507
630.0MHz	0.829 / -74.166
830.0MHz	0.761 / -91.703
1.030GHz	0.706 / -106.400
1.230GHz	0.666 / -118.632
1.430GHz	0.640 / -128.809
1.630GHz	0.630 / -137.406
1.830GHz	0.635 / -144.982
2.030GHz	0.654 / -152.132
2.230GHz	0.687 / -159.368
2.430GHz	0.728 / -167.002
2.630GHz	0.773 / -175.121
2.830GHz	0.819 / 176.361
3.030GHz	0.860 / 167.614
3.230GHz	0.896 / 158.820
3.430GHz	0.925 / 150.128
3.630GHz	0.948 / 141.643
3.830GHz	0.964 / 133.423
4.030GHz	0.975 / 125.491
4.230GHz	0.981 / 117.850
4.430GHz	0.982 / 110.485
4.630GHz	0.980 / 103.380
4.830GHz	0.973 / 96.518
5.030GHz	0.963 / 89.892
5.230GHz	0.948 / 83.512
5.430GHz	0.929 / 77.411
5.630GHz	0.905 / 71.655
5.830GHz	0.877 / 66.344
6.000GHz	0.852 / 62.271

Load

freq	S(2,2)
30.00MHz	0.981 / 176.647
230.0MHz	0.972 / 155.219
430.0MHz	0.950 / 127.187
630.0MHz	0.844 / 82.634
830.0MHz	0.601 / 10.089
1.030GHz	0.509 / -68.802
1.230GHz	0.556 / -114.349
1.430GHz	0.598 / -138.063
1.630GHz	0.627 / -152.220
1.830GHz	0.651 / -161.741
2.030GHz	0.678 / -168.936
2.230GHz	0.708 / -175.101
2.430GHz	0.741 / 179.055
2.630GHz	0.774 / 173.238
2.830GHz	0.804 / 167.397
3.030GHz	0.830 / 161.580
3.230GHz	0.852 / 155.844
3.430GHz	0.870 / 150.230
3.630GHz	0.884 / 144.755
3.830GHz	0.895 / 139.422
4.030GHz	0.905 / 134.221
4.230GHz	0.912 / 129.140
4.430GHz	0.919 / 124.164
4.630GHz	0.924 / 119.274
4.830GHz	0.929 / 114.457
5.030GHz	0.933 / 109.694
5.230GHz	0.937 / 104.969
5.430GHz	0.941 / 100.267
5.630GHz	0.944 / 95.573
5.830GHz	0.948 / 90.874
6.000GHz	0.951 / 86.866

TQP2420B

Preliminary Datasheet

Device Junction Temperature

•The plot is an estimate of the first and second stage transistor temperatures for an amplifier biased at a collector voltage of 3.3V and Vref= 2.95V. The paddle temperature is +85 deg-C. The actual temperature will vary dependent on the method used to attach the package to the final assembly board.

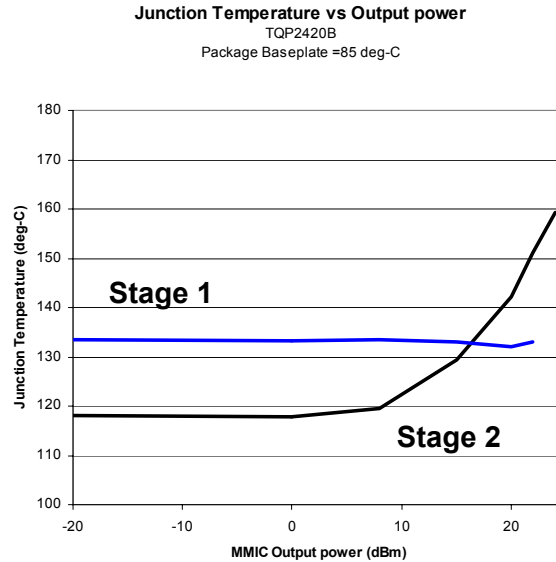

Package Outline

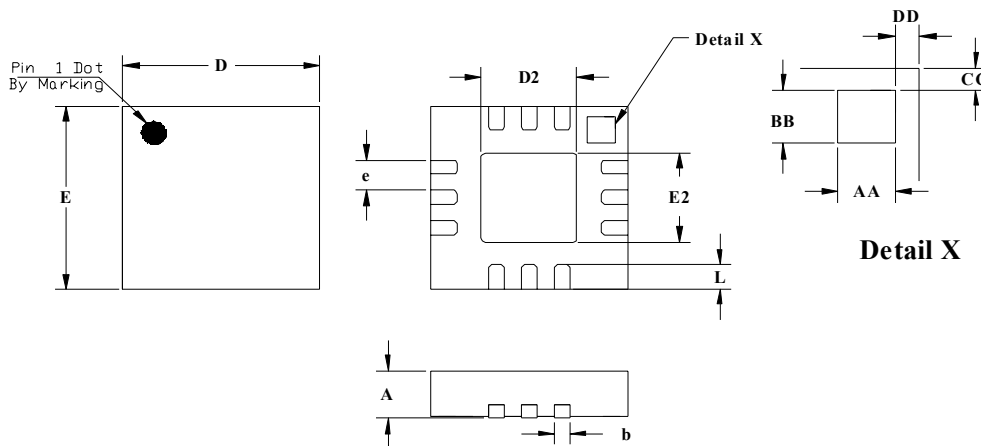

JEDEC DESIGNATION	DESCRIPTION	METRIC	ENGLISH	NOTE
A	OVERALL HEIGHT	0.90 +/- .10 mm	.035 +/- .004 in	1
b	TERMINAL WIDTH	0.23 +/- .07 mm	.009 +/- .003 in	1
D	PACKAGE LENGTH	3.00 mm BSC	.118 in	1
D2	EXPOSED PAD LENGTH	1.45 +/- .10 mm	.057 +/- .004 in	1
e	TERMINAL PITCH	0.50 mm BSC	.020 in	1
E	PACKAGE WIDTH	3.00 mm BSC	.118 in	1
E2	EXPOSED PAD WIDTH	1.45 +/- .10 mm	.057 +/- .004 in	1
L	TERMINAL LENGTH	0.40 +/- .10 mm	.016 +/- .004 in	1
AA	PIN 1 ID LENGTH	0.43 mm BSC	.017 in	1
BB	PIN 1 ID WIDTH	0.43 mm BSC	.017 in	1
CC	PIN 1 ID TO EDGE	0.18 mm BSC	.007 in	1
DD	PIN 1 ID TO EDGE	0.18 mm BSC	.007 in	1

Notes:
1. PRIMARY DIMENSIONS ARE IN METRIC MILLIMETERS. THE ENGLISH EQUIVALENTS ARE CALCULATED AND SUBJECT TO ROUNDING ERROR.

TQP2420B

Preliminary Datasheet

Package Marking

Pin 1



Line 1: 2420
Line 2: XXXX TriQuint Assembly Lot Number
Line 3: Manufacturing year and work week

Caution: Electrostatic discharge sensitive. Observe handling Precautions!

Part Ordering Information

Type	Marking	Ordering code (tape and reel)	Package
TQP2420B	2420	TBD	VQFN12 3x3mm 12 Lead

Additional Information

For latest specifications, additional product information, worldwide sales and distribution locations, and information about TriQuint:

Web: www.triquint.com **Tel:** (503) 615-9000
Email: info_wireless@tqs.com **Fax:** (503) 615-8902

For technical questions and additional information on specific applications:

Email: info_wireless@tqs.com

The information provided herein is believed to be reliable; TriQuint assumes no liability for inaccuracies or omissions. TriQuint assumes no responsibility for the use of this information, and all such information shall be entirely at the user's own risk. Prices and specifications are subject to change without notice. No patent rights or licenses to any of the circuits described herein are implied or granted to any third party.

TriQuint does not authorize or warrant any TriQuint product for use in life-support devices and/or systems.

Copyright © 2003 TriQuint Semiconductor, Inc. All rights reserved.

Revision 1.1, August 26, 2003