

TR115-F1



Telecommunications Switch
Optocoupler/1 Form A Relay

DESCRIPTION

The TR115-F1 is a dual function circuit designed specifically as a telecommunications switch. It consists an optically isolated solid state relay separated from an optocoupler. The relay portion is composed of an LED on the input, optically coupled to a sensing circuit which drives two source-to-source DMOS transistors. The optocoupler portion of the package consists of two back-to-back LEDs that drive an output phototransistor. The flatpack package is ideal for PCMCIA-type applications.

FEATURES

- Function integration (SSR + Optocoupler) in compact pkg.
- 20 ohms max on-resistance (Relay Portion)
- 120mA max continuous load current (Relay Portion)
- Flatpack (.09" pkg ht) ideal for PCMCIA applications
- Low input control current (2.5mA TYP, Relay Portion)

APPLICATIONS

- Telecom switching
- PCMCIA cards
- Fax/modem modules
- Set-top boxes
- DAA arrangements
- Hookswitch
- Loop current detect
- Pulse dialing

OPTIONS/SUFFIXES*

- -H High Output Isolation
- -TR Tape and Reel

NOTE: Suffixes listed above are not included in marking on device for part number identification.

SCHEMATIC DIAGRAM

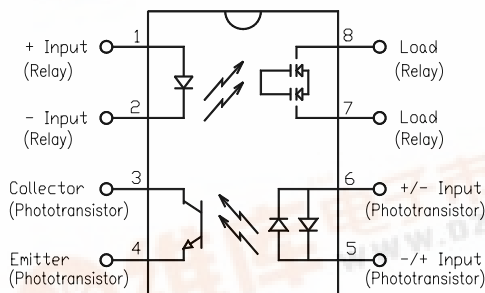

ABSOLUTE MAXIMUM RATINGS*

PARAMETER	UNIT	MIN	TYP	MAX
Storage Temperature	°C	-55		125
Operating Temperature	°C	-40		85
Continuous Input Current	mA			40
Transient Input Current	mA			400
Reverse Input Control Voltage	V	6		
Output Power Dissipation	mW			500

*The values indicated are absolute stress ratings. Functional operation of the device is not implied at these or any conditions in excess of those defined in electrical characteristics section of this document. Exposure to Absolute Ratings may cause permanent damage to the device and may adversely affect reliability.

APPROVALS

- BAPT CERTIFICATE #607835:
BS EN 60950, BS EN 41003, BS EN 60065
- CSA CERTIFICATE #LR111581-1
- UL FILE #E90096

ELECTRICAL CHARACTERISTICS - 25°C

PARAMETER	UNIT	MIN	TYP	MAX	TEST CONDITIONS
RELAY INPUT SPECIFICATIONS					
LED Forward Voltage	V		1.2	1.5	If = 10mA
LED Reverse Voltage	V	6	12		I _r = 10uA
Turn-On Current	m A		2.5	5	I _o = 120mA
Turn-Off Current	m A		0.5		
RELAY OUTPUT SPECIFICATIONS					
Blocking Voltage	V	400			I _o = 1uA
Continuous Load Current	m A			120	If = 5mA
On-Resistance	Ω		17	20	I _o = 120mA
Leakage Current	μ A		0.2	1	V _o = 400V
Output Capacitance	p F		25	50	V _o = 25V, f = 1.0MHz
Offset Voltage	m V			0.2	If = 5mA
Turn-On Time	m s		1	5	If = 5mA, I _o = 120mA
Turn-Off Time	m s		0.5	1	If = 5mA, I _o = 120mA
PHOTOTRANSISTOR INPUT SPECIFICATIONS					
LED Forward Voltage	V		1.2	1.5	If = 10mA
Turn-On Current	m A	2			I _o = 0.5mA
PHOTOTRANSISTOR OUTPUT SPECIFICATIONS					
Breakdown Voltage	V	60			I _o = 10uA
Leakage Current	n A			500	V _{ce} = 20V
Collector-Emitter Capacitance	p F		6		V _{ce} = 0V, f = 1.0kHz
Saturation Voltage	V			0.5	If = 5mA
Current Transfer Ratio	%	30	100	800	If = 2mA, V _{ce} = 5V
COUPLED SPECIFICATIONS					
Isolation Voltage	V	2500			T = 1 minute
-H Suffix	V	3750			T = 1 minute
Isolation Resistance	G Ω	100			
Coupled Capacitance	p F			2	
Contact Transient Ratio	V / μ s	2000	7000		dV = 50V

PERFORMANCE DATA

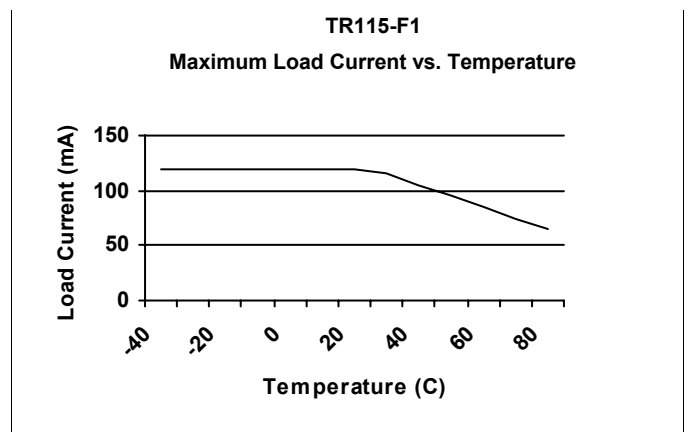
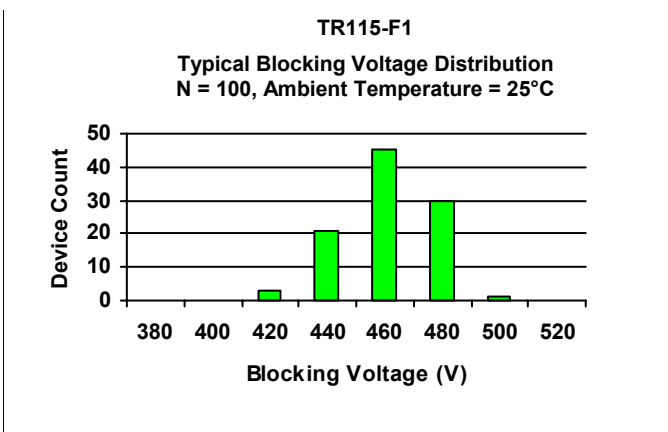
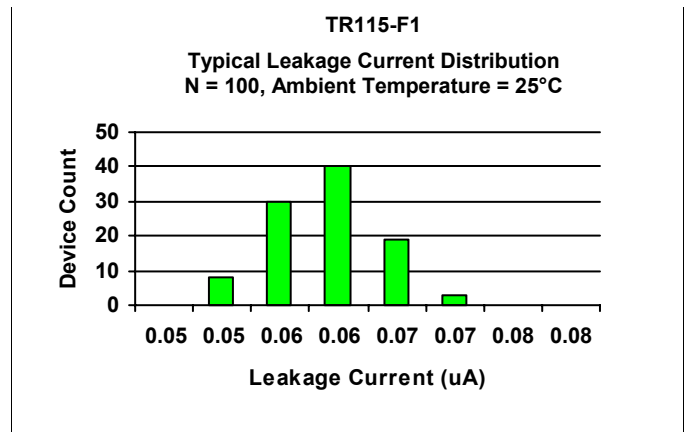
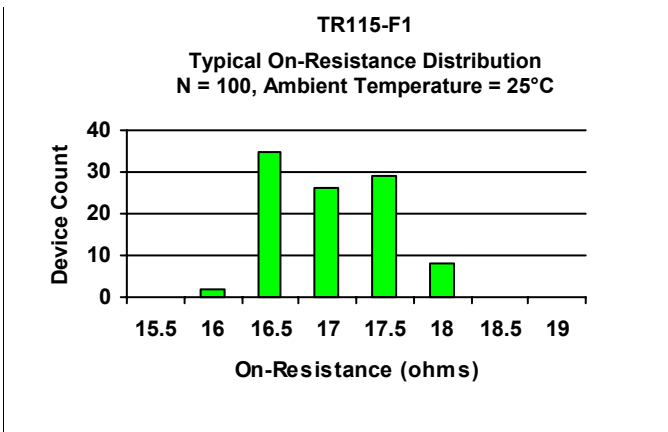
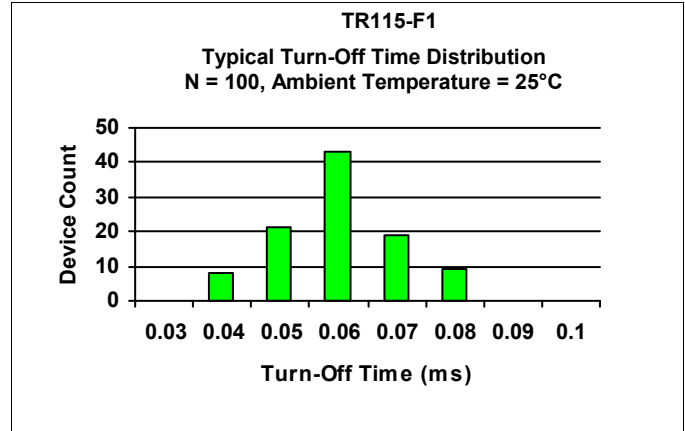
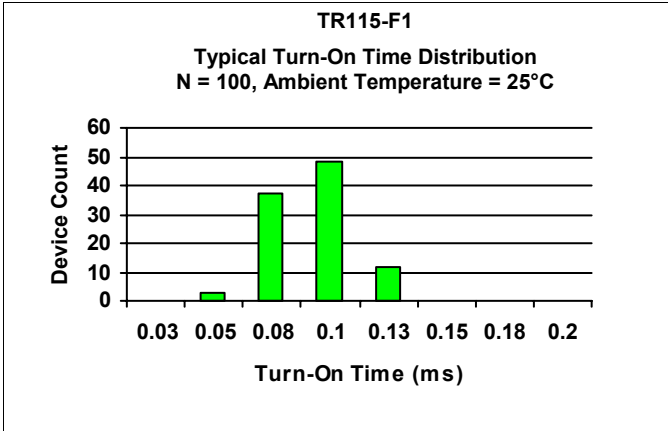

MECHANICAL DIMENSIONS

8 PIN FLATPACK PACKAGE

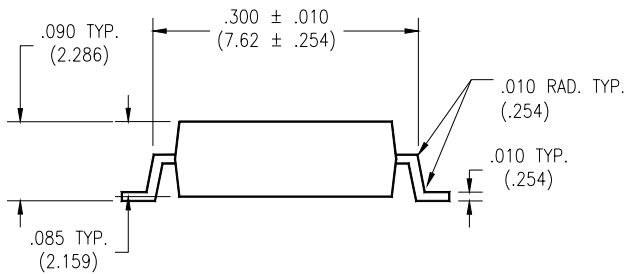

END VIEW

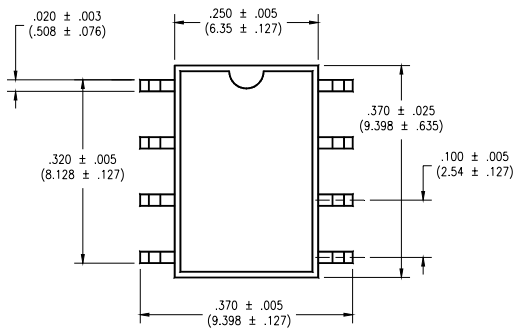

TOP VIEW

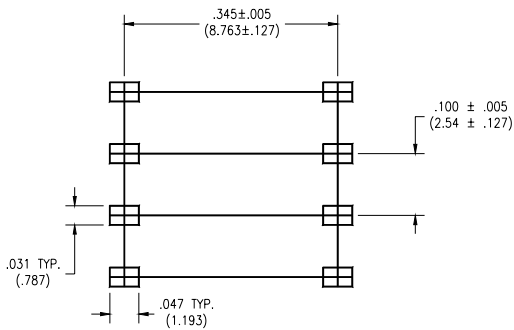

BOTTOM VIEW

DISCLAIMER

Solid State Optronics (SSO) makes no warranties or representations with regards to the completeness and accuracy of this document. SSO reserves the right to make changes to product description, specifications at any time without further notice. SSO shall not assume any liability arising out of the application or use of any product or circuit described herein. Neither circuit patent licenses nor indemnity are expressed or implied. Except as specified in SSO's Standard Terms & Conditions, SSO disclaims liability for consequential or other damage, and we make no other warranty, expressed or implied, including merchantability and fitness for particular use.

LIFE SUPPORT POLICY

SSO does not authorize use of its devices in life support applications wherein failure or malfunction of a device may lead to personal injury or death. Users of SSO devices in life support applications assume all risks of such use and agree to indemnify SSO against any and all damages resulting from such use. Life support devices are defined as devices or systems which, (a) are intended for surgical implant into the body, or (b) support or sustain life, and (c) whose failure to perform when used properly in accordance with instructions for use can be reasonably expected to result in significant injury to the user, or (d) a critical component in any component of a life support device or system whose failure can be reasonably expected to cause failure of the life support device or system, or to affect its safety or effectiveness.
