



查询TSL257T供应商

TAOS TEXAS
ADVANCED
OPTOELECTRONIC
SOLUTIONS®

捷多邦, 专业PCB打样工厂, 24小时加急出货

TSL257T
HIGH-SENSITIVITY
LIGHT-TO-VOLTAGE CONVERTER

TAOS065B – APRIL 2007

- Converts Light Intensity to Output Voltage
- Monolithic Silicon IC Containing Photodiode, Operational Amplifier, and Feedback Components
- High Sensitivity
- Single Voltage Supply Operation (2.7 V to 5.5 V)
- High Irradiance Responsivity . . . Typical 680 mV/($\mu\text{W}/\text{cm}^2$) at $\lambda_p = 640 \text{ nm}$
- Low Noise (200 μVrms Typ to 1 kHz)
- Rail-to-Rail Output
- High Power-Supply Rejection (35 dB at 1 kHz)
- Low-Profile Surface-Mount Package
- RoHS Compliant

PACKAGE T
4-LEAD SMD
(TOP VIEW)

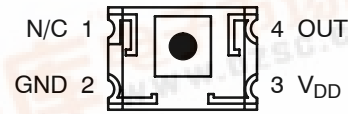

Description

The TSL257T is a high-sensitivity low-noise light-to-voltage optical converter that combines a photodiode and a transimpedance amplifier on a single monolithic CMOS integrated circuit. Output voltage is directly proportional to light intensity (irradiance) on the photodiode. The TSL257T has a transimpedance gain of 320 M Ω . The device has improved offset voltage stability and low power consumption and is supplied in a compact 4-lead surface-mount package.

Functional Block Diagram

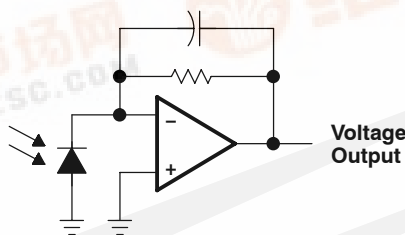

Terminal Functions

TERMINAL NAME	T PKG NO.	DESCRIPTION
GND	2	Power supply ground (substrate). All voltages are referenced to GND.
OUT	4	Output voltage.
V _{DD}	3	Supply voltage.
N/C	1	No connection.



TSL257T HIGH-SENSITIVITY LIGHT-TO-VOLTAGE CONVERTER

TAOS065B – APRIL 2007

Absolute Maximum Ratings over operating free-air temperature range (unless otherwise noted)†

Supply voltage, V_{DD} (see Note 1)	6 V
Output current, I_O	±10 mA
Duration of short-circuit current at (or below) 25°C	5 s
Operating free-air temperature range, T_A	–25°C to 85°C
Storage temperature range, T_{stg}	–25°C to 85°C
Solder conditions in accordance with JEDEC–J–SRD–020A, maximum temperature	260°C

† Stresses beyond those listed under “absolute maximum ratings” may cause permanent damage to the device. These are stress ratings only, and functional operation of the device at these or any other conditions beyond those indicated under “recommended operating conditions” is not implied. Exposure to absolute-maximum-rated conditions for extended periods may affect device reliability.

NOTE 1: All voltages are with respect to GND.

Recommended Operating Conditions

	MIN	MAX	UNIT
Supply voltage, V_{DD}	2.7	5.5	V
Operating free-air temperature, T_A	0	70	°C

Electrical Characteristics at $V_{DD} = 5\text{ V}$, $T_A = 25^\circ\text{C}$, $\lambda_p = 640\text{ nm}$, $R_L = 10\text{ k}\Omega$ (unless otherwise noted) (see Notes 2, 3, and 4)

PARAMETER	TEST CONDITIONS	MIN	TYP	MAX	UNIT
V_D Dark voltage	$E_e = 0$	0		15	mV
V_{OM} Maximum output voltage swing	$V_{DD} = 4.5\text{ V}$, No Load		4.49		V
	$V_{DD} = 4.5\text{ V}$, $R_L = 10\text{ k}\Omega$	4	4.2		
V_O Output voltage	$E_e = 2.93\ \mu\text{W}/\text{cm}^2$	1.5	2	2.5	V
α_{VD} Temperature coefficient of dark voltage (V_D)	$T_A = 0^\circ\text{C}$ to 70°C		–15		$\mu\text{V}/^\circ\text{C}$
R_e Irradiance responsivity	See Note 5		680		$\text{mV}/(\mu\text{W}/\text{cm}^2)$
PSRR Power supply rejection ratio	$f_{ac} = 100\text{ Hz}$, see Note 6		55		dB
	$f_{ac} = 1\text{ kHz}$, see Note 6		35		
I_{DD} Supply current	$E_e = 2.93\ \mu\text{W}/\text{cm}^2$		2	3.8	mA

NOTES: 2. Measured with $R_L = 10\text{ k}\Omega$ between output and ground.

3. Optical measurements are made using small-angle incident radiation from a light-emitting diode (LED) optical source.

4. The input irradiance E_e is supplied by an AlInGaP LED with peak wavelength $\lambda_p = 640\text{ nm}$.

5. Irradiance responsivity is characterized over the range $V_O = 0.1\text{ V}$ to 4.5 V . The best-fit straight line of Output Voltage V_O versus Irradiance E_e over this range will typically have a positive extrapolated V_O value for $E_e = 0$.

6. Power supply rejection ratio PSRR is defined as $20\ \log(\Delta V_{DD}(f)/\Delta V_O(f))$ with $V_{DD}(f=0) = 5\text{ V}$ and $V_O(f=0) = 2\text{ V}$.

Switching Characteristics at $V_{DD} = 5\text{ V}$, $T_A = 25^\circ\text{C}$, $\lambda_p = 640\text{ nm}$, $R_L = 10\text{ k}\Omega$ (unless otherwise noted)

PARAMETER	TEST CONDITIONS	MIN	TYP	MAX	UNIT
t_r Output pulse rise time, 10% to 90% of final value	See Note 10 and Figure 1		160	250	μs
t_f Output pulse fall time, 10% to 90% of final value	See Note 10 and Figure 1		150	250	μs
t_s Output settling time to 1% of final value	See Note 10 and Figure 1		330		μs
V_n Output noise voltage, rms	Integrated noise voltage	$f = \text{dc}$ to 1 kHz $E_e = 0$		200	μVrms
	V_n Output noise voltage, rms	$f = 10\text{ Hz}$ $E_e = 0$		6	$\mu\text{V}/\sqrt{\text{Hz}}$ rms
		$f = 100\text{ Hz}$ $E_e = 0$		6	
		$f = 1\text{ kHz}$ $E_e = 0$		7	

NOTE 7: Switching characteristics apply over the range $V_O = 0.1\text{ V}$ to 4.5 V .

PARAMETER MEASUREMENT INFORMATION

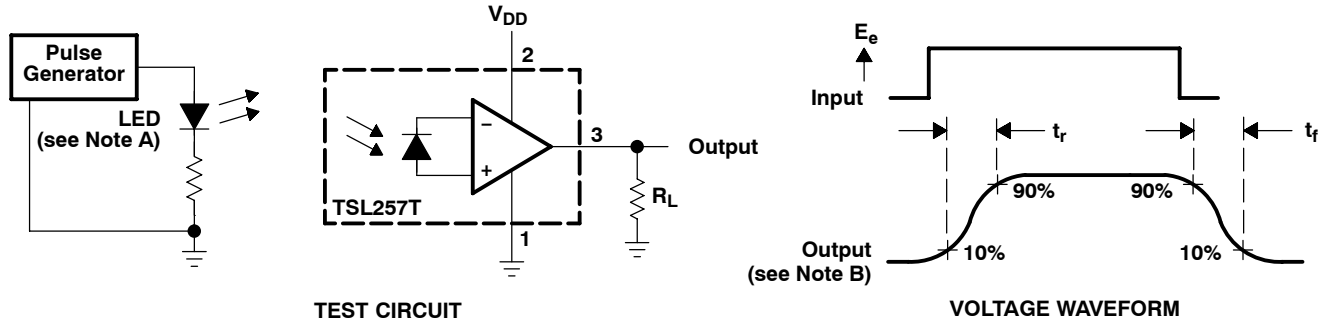

NOTES: A. The input irradiance is supplied by a pulsed AlInGaP light-emitting diode with the following characteristics: $\lambda_p = 640 \text{ nm}$, $t_r < 1 \mu\text{s}$, $t_f < 1 \mu\text{s}$.
 B. The output waveform is monitored on an oscilloscope with the following characteristics: $t_r < 100 \text{ ns}$, $Z_i \geq 1 \text{ M}\Omega$, $C_i \leq 20 \text{ pF}$.

Figure 1. Switching Times

TYPICAL CHARACTERISTICS

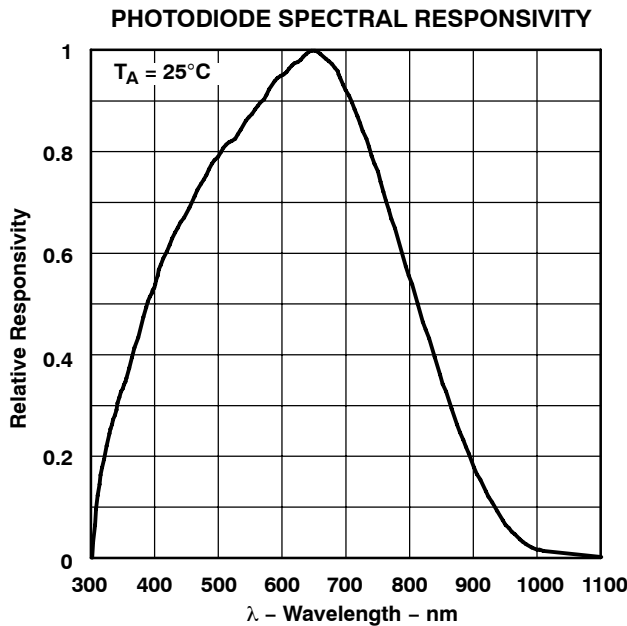

Figure 2

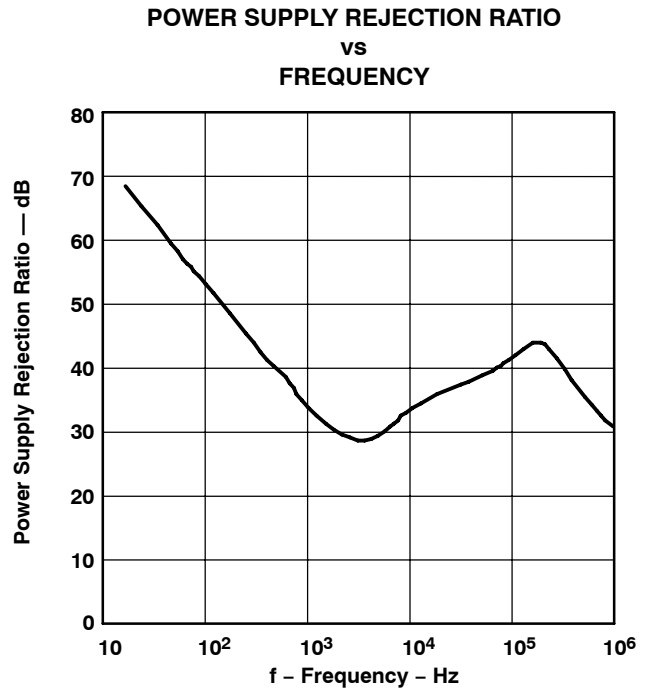

Figure 3

TYPICAL CHARACTERISTICS

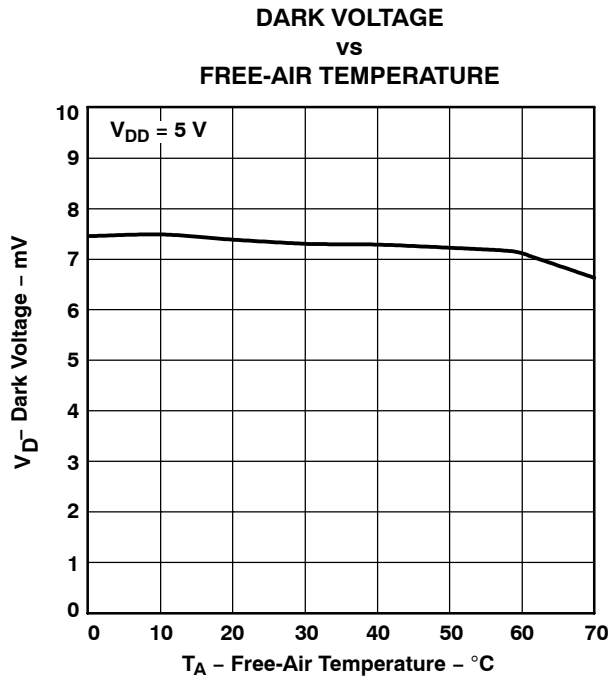

Figure 4

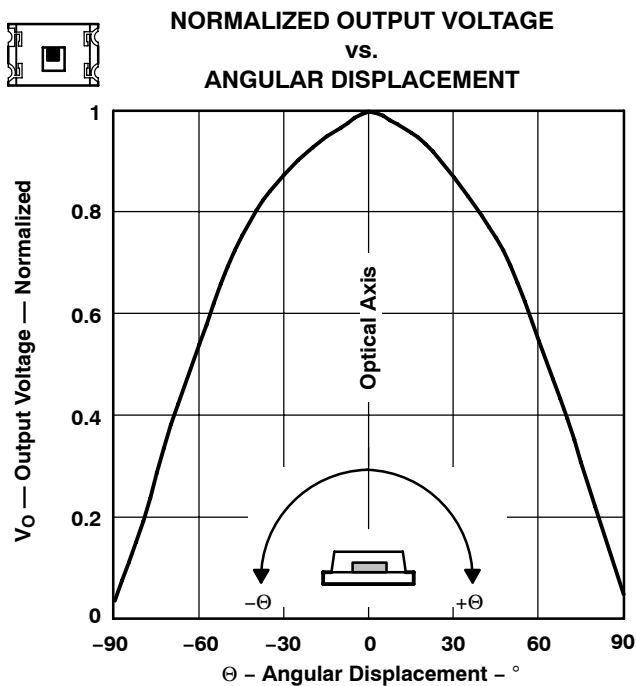

Figure 5

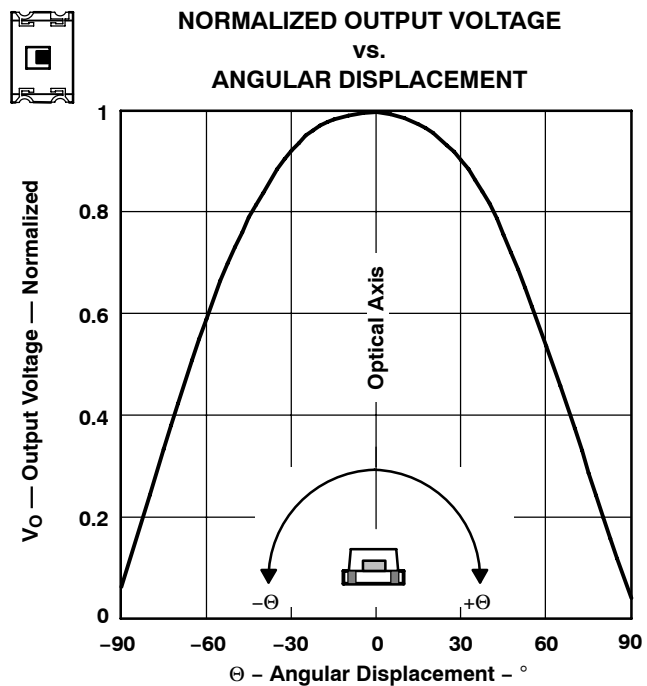
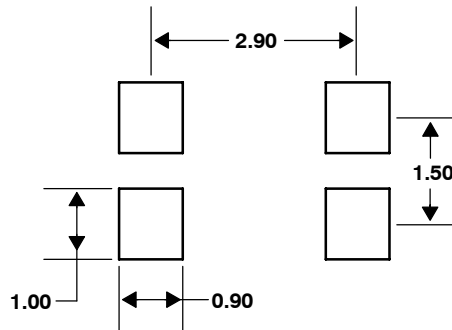

Figure 6

APPLICATION INFORMATION

PCB Pad Layout

Suggested PCB pad layout guidelines for the T package are shown in Figure 7.



- NOTES: A. All linear dimensions are in millimeters.
B. This drawing is subject to change without notice.

Figure 7. Suggested T Package PCB Layout

TSL257T
HIGH-SENSITIVITY
LIGHT-TO-VOLTAGE CONVERTER

TAOS065B – APRIL 2007

MECHANICAL DATA

The TSL257T is supplied in a low-profile surface-mount package. This package contains no lead (Pb).

PACKAGE T

Four-Lead Surface Mount Device

TOP VIEW

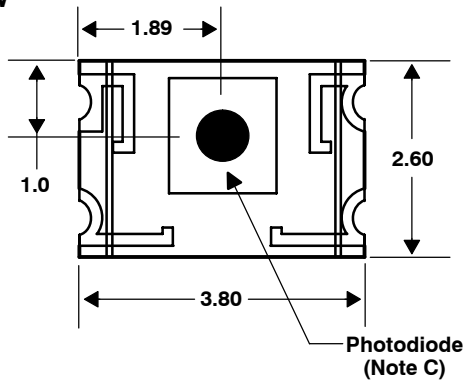

DETAIL A: TYPICAL PACKAGE TERMINAL

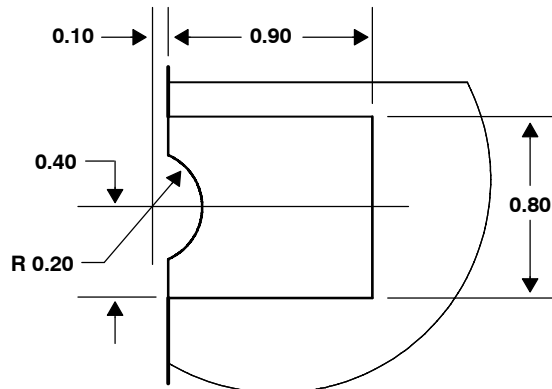

SIDE VIEW

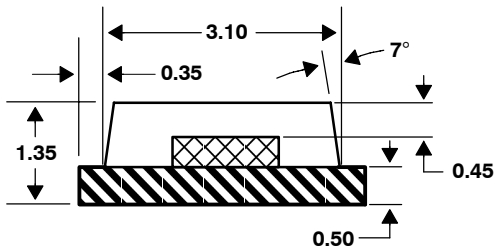

BOTTOM VIEW

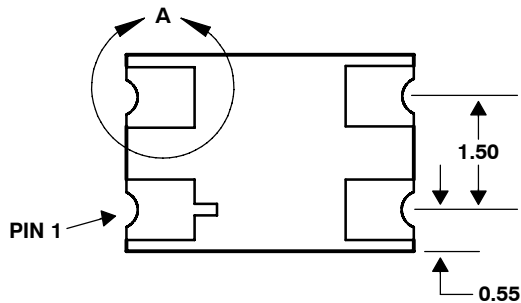

Lead Free

- NOTES: A. All linear dimensions are in millimeters.
 B. Terminal finish is gold.
 C. The center of the 0.75 mm diameter integrated photodiode active area is typically located 0.1 mm above the center of the package.
 D. Dimension tolerance is ± 0.15 mm.
 E. This drawing is subject to change without notice.

Figure 8. Package T — Four-Lead Surface Mount Device Packaging Configuration

MECHANICAL DATA

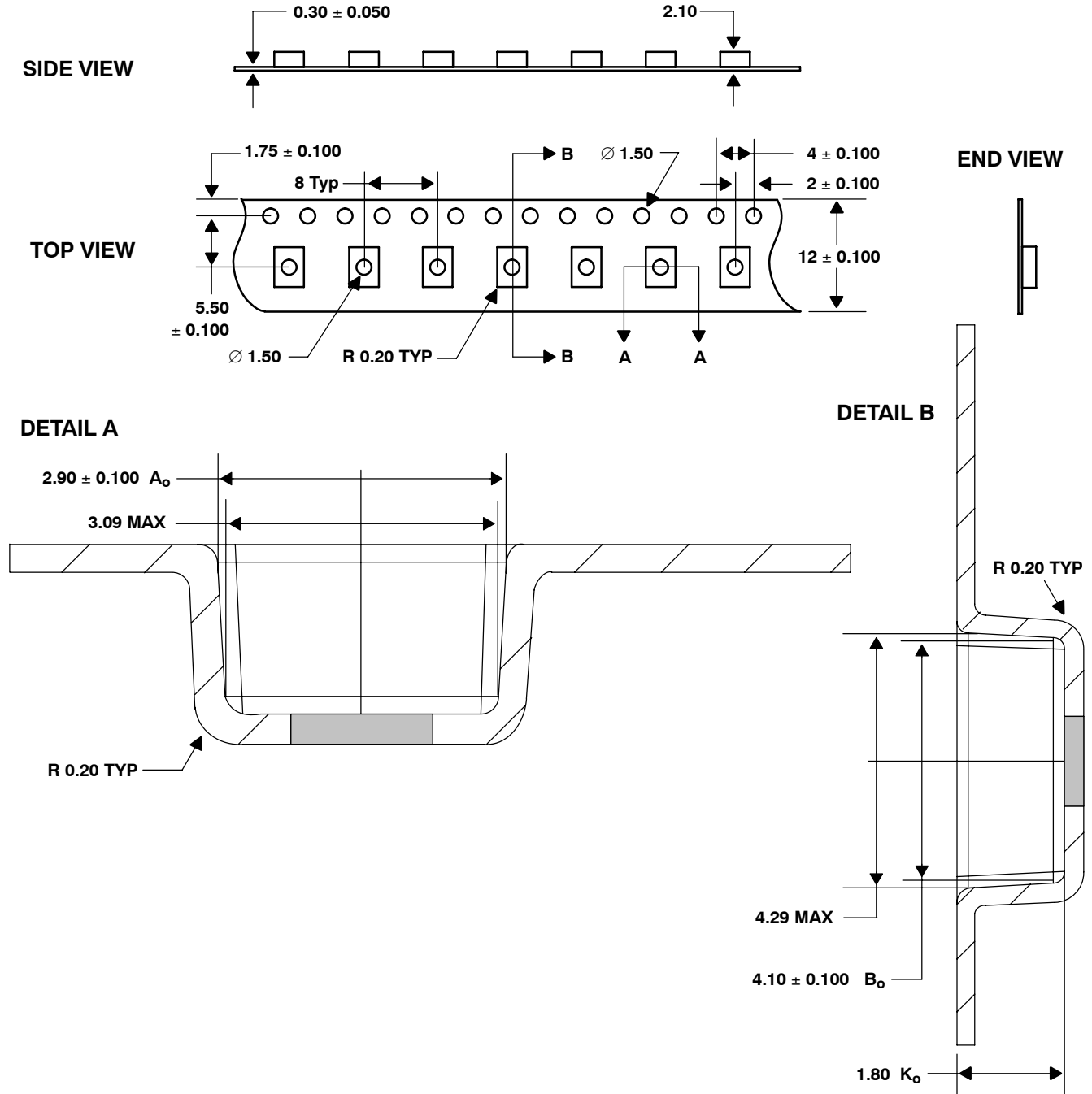

- NOTES: A. All linear dimensions are in millimeters.
 B. The dimensions on this drawing are for illustrative purposes only. Dimensions of an actual carrier may vary slightly.
 C. Symbols on drawing A_o , B_o , and K_o are defined in ANSI EIA Standard 481-B 2001.
 D. Each reel is 178 millimeters in diameter and contains 1000 parts.
 E. TAOS packaging tape and reel conform to the requirements of EIA Standard 481-B.
 F. In accordance with EIA standard, device pin 1 is located next to the sprocket holes in the tape.
 G. This drawing is subject to change without notice.

Figure 9. Four Lead Surface Mount Package Carrier Tape

TSL257T
HIGH-SENSITIVITY
LIGHT-TO-VOLTAGE CONVERTER

TAOS065B – APRIL 2007

MANUFACTURING INFORMATION

The reflow profile specified here describes expected maximum heat exposure of devices during the solder reflow process of the device on a PWB. Temperature is measured at the top of the device. Devices should be limited to one pass through the solder reflow profile.

Table 1. TSL257T Solder Reflow Profile

PARAMETER	REFERENCE	TSL257T
Average temperature gradient in preheating		2.5°C/sec
Soak time	t_{soak}	2 to 3 minutes
Time above T_1 , 217°C	t_1	Max 60 sec
Time above T_2 , 230°C	t_2	Max 50 sec
Time above T_3 , ($T_{peak} - 10^\circ\text{C}$)	t_3	Max 10 sec
Peak temperature in reflow	T_{peak}	260° C (-0°C/+5°C)
Temperature gradient in cooling		Max -5°C/sec

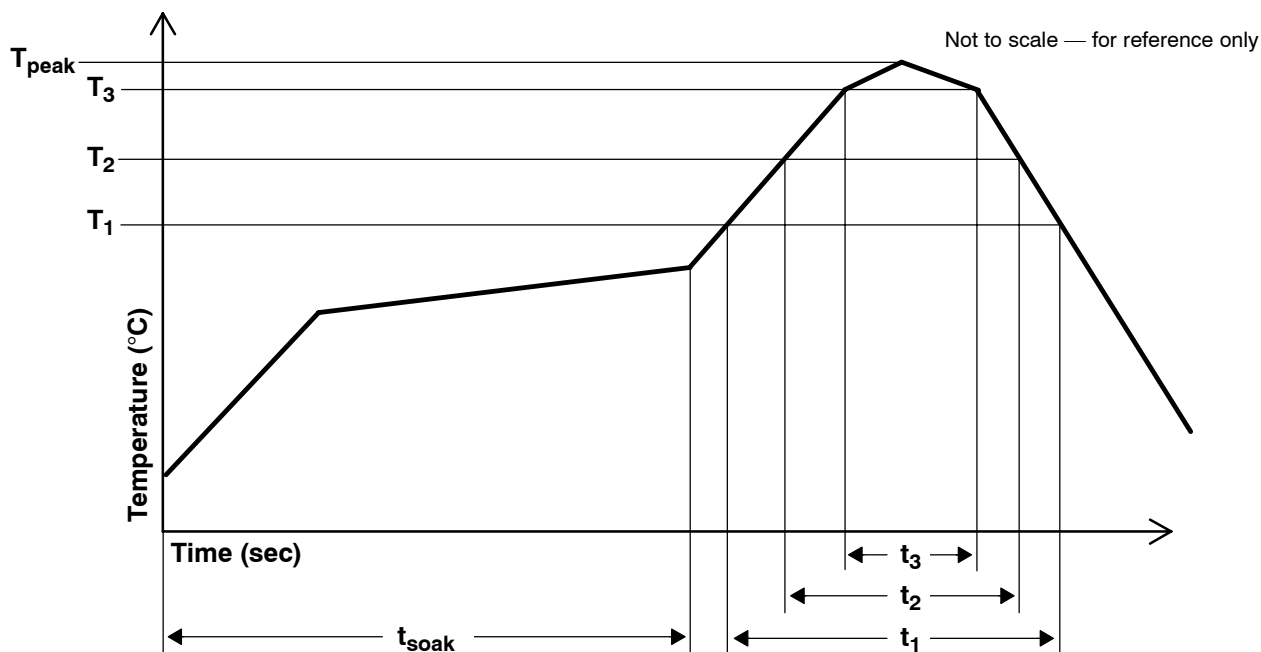

Figure 10. TSL257T Solder Reflow Profile

MANUFACTURING INFORMATION

Moisture Sensitivity

Optical characteristics of the device can be adversely affected during the soldering process by the release and vaporization of moisture that has been previously absorbed into the package molding compound. To ensure the package molding compound contains the smallest amount of absorbed moisture possible, each device is dry-baked prior to being packed for shipping. Devices are packed in a sealed aluminized envelope with silica gel to protect them from ambient moisture during shipping, handling, and storage before use.

This package has been assigned a moisture sensitivity level of MSL 3 and the devices should be stored under the following conditions:

Temperature Range	5°C to 50°C
Relative Humidity	60% maximum
Total Time	6 months from the date code on the aluminized envelope — if unopened
Opened Time	168 hours or fewer

Rebaking will be required if the devices have been stored unopened for more than 6 months or if the aluminized envelope has been open for more than 168 hours. If rebaking is required, it should be done at 90°C for 4 hours.

TSL257T HIGH-SENSITIVITY LIGHT-TO-VOLTAGE CONVERTER

TAOS065B – APRIL 2007

PRODUCTION DATA — information in this document is current at publication date. Products conform to specifications in accordance with the terms of Texas Advanced Optoelectronic Solutions, Inc. standard warranty. Production processing does not necessarily include testing of all parameters.

LEAD-FREE (Pb-FREE) and GREEN STATEMENT

Pb-Free (RoHS) TAOS' terms *Lead-Free* or *Pb-Free* mean semiconductor products that are compatible with the current RoHS requirements for all 6 substances, including the requirement that lead not exceed 0.1% by weight in homogeneous materials. Where designed to be soldered at high temperatures, TAOS Pb-Free products are suitable for use in specified lead-free processes.

Green (RoHS & no Sb/Br) TAOS defines *Green* to mean Pb-Free (RoHS compatible), and free of Bromine (Br) and Antimony (Sb) based flame retardants (Br or Sb do not exceed 0.1% by weight in homogeneous material).

Important Information and Disclaimer The information provided in this statement represents TAOS' knowledge and belief as of the date that it is provided. TAOS bases its knowledge and belief on information provided by third parties, and makes no representation or warranty as to the accuracy of such information. Efforts are underway to better integrate information from third parties. TAOS has taken and continues to take reasonable steps to provide representative and accurate information but may not have conducted destructive testing or chemical analysis on incoming materials and chemicals. TAOS and TAOS suppliers consider certain information to be proprietary, and thus CAS numbers and other limited information may not be available for release.

NOTICE

Texas Advanced Optoelectronic Solutions, Inc. (TAOS) reserves the right to make changes to the products contained in this document to improve performance or for any other purpose, or to discontinue them without notice. Customers are advised to contact TAOS to obtain the latest product information before placing orders or designing TAOS products into systems.

TAOS assumes no responsibility for the use of any products or circuits described in this document or customer product design, conveys no license, either expressed or implied, under any patent or other right, and makes no representation that the circuits are free of patent infringement. TAOS further makes no claim as to the suitability of its products for any particular purpose, nor does TAOS assume any liability arising out of the use of any product or circuit, and specifically disclaims any and all liability, including without limitation consequential or incidental damages.

TEXAS ADVANCED OPTOELECTRONIC SOLUTIONS, INC. PRODUCTS ARE NOT DESIGNED OR INTENDED FOR USE IN CRITICAL APPLICATIONS IN WHICH THE FAILURE OR MALFUNCTION OF THE TAOS PRODUCT MAY RESULT IN PERSONAL INJURY OR DEATH. USE OF TAOS PRODUCTS IN LIFE SUPPORT SYSTEMS IS EXPRESSLY UNAUTHORIZED AND ANY SUCH USE BY A CUSTOMER IS COMPLETELY AT THE CUSTOMER'S RISK.

LUMENOLOGY, TAOS, the TAOS logo, and Texas Advanced Optoelectronic Solutions are registered trademarks of Texas Advanced Optoelectronic Solutions Incorporated.

