



UAF11
UAF21

UNIVERSAL ACTIVE FILTERS

FEATURES

- **SAVES DESIGN TIME**
User-tuneable frequency, Q-factor, gain
Calculate only three resistance values
Design directly from this data sheet
Completely characterized parameters
- **IMPROVED PERFORMANCE**
Wide frequency ranges
UAF11 - 0.001Hz to 20kHz
UAF21 - 0.001Hz to 200kHz
1% frequency accuracy
Q range of 0.5 to 500
Reliable hybrid construction
NPO capacitors and thin-film resistors

APPLICATIONS

- **FILTER CONFIGURATIONS**
Butterworth
Bessel
Chebyshev
- **FILTER FUNCTIONS**
Low pass
High pass
Bandpass
Band reject

DESCRIPTION

The UAF11's and UAF21's are low cost universal active filters. These versatile units can easily be tailored to any active filter application using the extensive information provided in this data sheet. UAF's are excellent choices for use in communications equipment, test equipment (engine analyzers, aircraft and automotive test, medical test, etc.), servo systems, process control equipment, sonar and many others.

The UAF11's and UAF21's are complete two-pole active filters with the addition of four external resistors that provide the user easy control of the

Q-factor, resonant frequency and gain. Any complex filter response can be obtained by cascading these units. Three separate outputs provide low-pass, high-pass, and bandpass transfer functions. A band-reject (notch) transfer function may be realized simply by summing the high-pass and low-pass outputs.

Since these UAF's are so versatile and flexible, they can be stocked by the user in quantity for use as building blocks whenever the requirement arises. This means instant availability and the UAF purchases may be made in volume to take advantage of quantity price discounts.

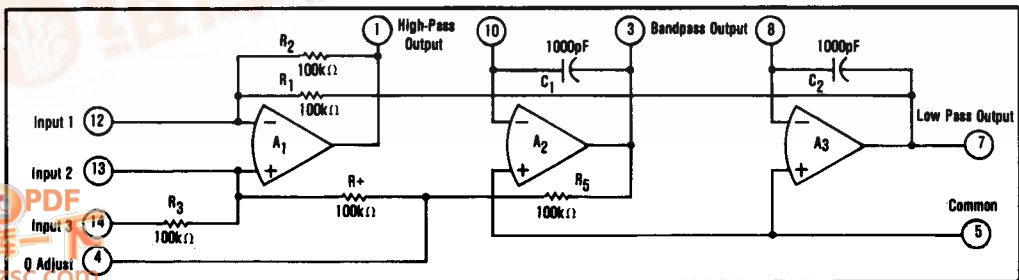

SPECIFICATIONS

ELECTRICAL

Typical at +25°C and with rated supply unless otherwise noted.

MODEL	UAF11	UAF21(1)	UNITS
INPUT			
Input Bias Current	±100	±15	nA
Input Voltage Range	±10	±10	V
Input Resistance	100k	100k	Ω
TRANSFER CHARACTERISTICS			
Frequency Range (f _o)	0.001 to 20k	0.001 to 200k	Hz
f _o Accuracy(2)	±1	±1	%
f _o Stability(3) (over temp. range)	±0.005	±0.005	%/°C
Q Range(4)	0.5 to 500	0.5 to 500	--
Q Stability(5)			
at f _o Q ≤ 10 ⁴	±0.025	±0.01	%/°C
at f _o Q ≤ 10 ⁵	±0.1	±0.025	%/°C
Gain Range	0.1 to 50	0.1 to 50	--
OUTPUT			
Slew Rate	0.6	6.0	V/μsec
Peak-to-Peak Output Swing(6)			
f _o ≤ 10kHz	20	20	V
f _o ≤ 20kHz	10	20	V
f _o ≤ 100kHz	2	20	V
Output Offset			
(at low-pass output with unity gain)	±10	±10	mV
Output Impedance	2	10	Ω
Noise(7)	200	200	μV _{rms}
Output Current(8)	10	10	mA
POWER SUPPLIES			
Rated Power Supplies	±15	±15	V
Power Supply Range(9)	±5 to ±18	±5 to ±18	V
Supply Current at ±15V (Quiescent)	±12, max	±12, max	mA
TEMPERATURE RANGE			
Specification: Epoxy	-25 to +85	-25 to +85	°C
Storage: Epoxy	-40 to +85	-40 to +85	°C

NOTES

- The UAF21 includes two internal 0.002μF power supply capacitors.
- Repeatability of f_o using 0.1% frequency determining resistors.
- T.C.R. of external frequency determining resistors must be added to this figure.
- Derated 50% from maximum - see Typical Performance Curves.
- Q stability varies with both the value of Q and the resonant frequency f_o.
- Low-pass output - see Typical Performance Curves.
- Measured at the bandpass output with Q = 50 over DC to 50kHz.
- The current required to drive R_{F1} and R_{F2} (external) as well as C₁ and C₂ must come from this current.
- For supplies below ±10V, Q max will decrease slightly; filters will operate below ±5V.

PIN CONNECTIONS

Pin 1. High-Pass Output	Pin 8. Frequency Adjust
Pin 2. Optional Pin	Pin 9. -Supply
Pin 3. Bandpass Output	Pin 10. Frequency Adjust
Pin 4. Q Adjust Point	Pin 11. Optional Pin
Pin 5. Common	Pin 12. Input 1
Pin 6. +Supply	Pin 13. Input 2
Pin 7. Low-Pass Output	Pin 14. Input 3

MECHANICAL

EPOXY PACKAGE

NOTE:
Leads in true position within 0.10"
0.25mm R at MMC at seating plane.

ORDER NUMBER:
UAF11
UAF21
WEIGHT: 3.4 Grams
CONNECTOR:
0145MC

Pin numbers shown for reference only. Numbers may not be marked on package.

Note 1: Pin presence optional

DIM	INCHES		MILLIMETERS	
	MIN	MAX	MIN	MAX
A	.790	.810	20.07	20.57
B	.490	.510	12.45	12.95
C	.190	.260	4.83	6.60
D	.016	.021	0.46	0.53
G	.100 BASIC		2.54 BASIC	
H	.080	.115	2.03	2.92
K	.130	.300	3.30	7.62
L	.300 BASIC		7.62 BASIC	
R	.050	.115	2.03	2.92

UAF11/21

5

ANALOG CIRCUIT FUNCTIONS

TYPICAL PERFORMANCE CURVES

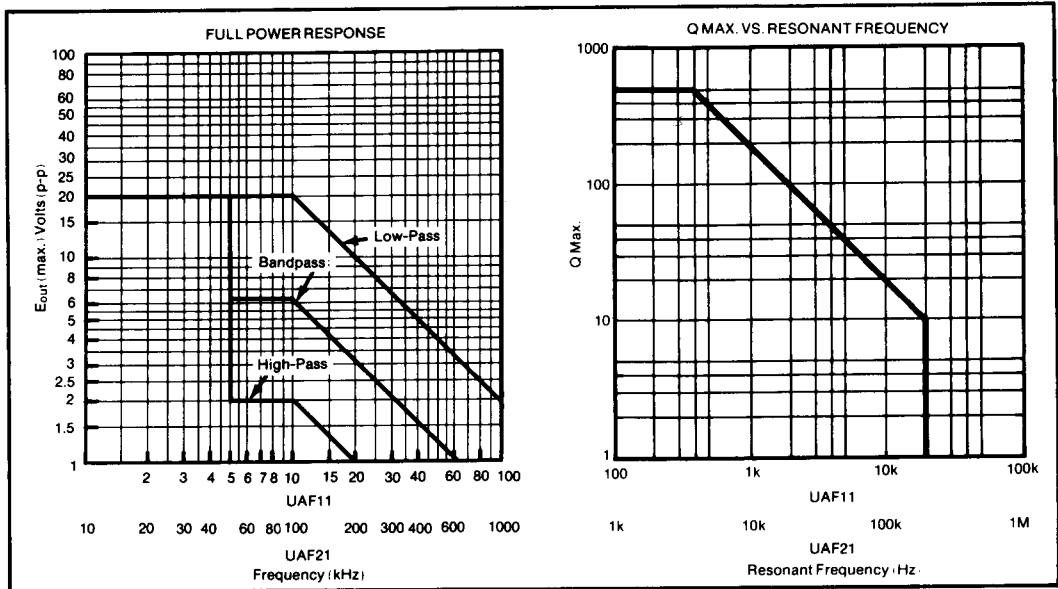

APPLICATIONS INFORMATION

TRANSFER FUNCTION

The UAF21 uses the state variable technique to produce a basic second order transfer function. The equation describing the three outputs available are:

$$T(\text{Low-Pass}) = \frac{A_{LP}\omega_0^2}{s^2 + (\omega_0/Q)s + \omega_0^2}$$

$$T(\text{Bandpass}) = \frac{A_{BP}(\omega_0/Q)s}{s^2 + (\omega_0/Q)s + \omega_0^2}$$

$$T(\text{High-Pass}) = \frac{A_{HP}s^2}{s^2 + (\omega_0/Q)s + \omega_0^2}$$

where $\omega_0 = 2\pi f_0$.

To obtain band reject characteristics the low-pass and high-pass outputs are summed to form a pair of $j\omega$ axis zeros:

$$T(\text{Band-Reject}) = \frac{A(s^2 + \omega_0^2)}{s^2 + (\omega_0/Q)s + \omega_0^2}$$

where $A_{LP} = A_{HP} = A$.

The state variable approach uses two op amp integrators and a summing amplifier to provide simultaneous low-pass, bandpass and high-pass responses. One UAF is required for each two poles of low-pass or high-pass filters and for each pole-pair of bandpass or band-reject filters.

DESIGN PROCEDURE SUMMARY

These procedures give the design steps for the proper application of a UAF and for the selection of the external components. More detailed information on filter theory pertinent to some of the steps can be found in the

TABLE I. Useful References.

1. Tobey, Gene, et al, Operational Amplifiers: Design and Applications, Chapter 8, McGraw-Hill Book Company, 1971.
2. Wong, Yu Jen, and William Ott: Function Circuits: Design and Applications, Chapter 6, McGraw-Hill Book Company, 1976.
3. Daniels, Richard W.: Approximation Methods for Electronic Filter Design, McGraw-Hill Book Company, 1974.
4. Zyerev, Anatol I.: Handbook of Filter Synthesis, John Wiley and Sons, 1967.
5. Temes, Gabor C., and Sanjit K. Mitra: Modern Filter Theory and Design, John Wiley and Sons, 1973.

Burr-Brown also manufactures a line of completely self-contained active filters called the ATF76 series. These are available in most popular transfer functions with from 2- to 8-pole responses. They contain all necessary components and do not require any user design effort.

DESIGN STEPS

1. Choose the type of function (low-pass, bandpass, etc.), type of response (Butterworth, Bessel, etc.), number of poles, and cutoff frequency based on the particular application.

If the transfer function is band-reject see Band-Reject Transfer Function before proceeding to step 2.

2. Determine the normalized low-pass filter parameters (f_n and Q) based on the type of response and number of poles selected in step 1. See Normalized Low-Pass Parameters.
3. If the actual response desired is low-pass go to step 4. For other responses a transformation of variables must be made (low-pass to bandpass or low-pass to high-pass).

- Determine the actual (denormalized) cutoff frequency, f_o , by multiplying f_n by the actual desired cutoff frequency. See Denormalization of Parameters.
- Pick the desired UAF configuration (noninverting, inverting or bi-quad). See Configuration Selection Guide and UAF Configurations and Design Equations.
- Decide whether to use design equations "A" or "B". See Design Equations "A" and "B".
- Calculate R_{F1} and R_{F2} . See Natural Frequency and UAF Configurations and Design Equations.
- Determine Q_P . See Q_P Procedure.
- Select the desired gain for each UAF and calculate the corresponding R_G and R_Q . See Gain (A) and UAF Configurations and Design Equations.

BAND-REJECT TRANSFER FUNCTION

The band-reject is achieved by summing the high-pass and low-pass UAF outputs. Either of the configurations in Figures 2 and 3 can be used to provide the band-reject function if they are used as shown in Figure 1.

The 15kΩ resistor is adjusted for maximum rejection. The circuit in Figure 3 is applicable when using design equations "A" ($A_{LP} = A_{HP}$). When design equations "B" are used ($A_{LP} = 10A_{HP}$), the resistor at pin 7 must be 10 times the resistor at pin 1 to obtain equal pass-band gains above and below f_o .

In either case, the four external UAF resistors (R_G , R_Q , R_{F1} and R_{F2}) should be calculated for f_o and Q of the band-reject filter desired and for A_{LP} to equal the desired pass-band gain. An input constraint is that the input voltage times A_{BP} must not exceed the rated peak-to-peak voltage of the bandpass output, or clipping will result.

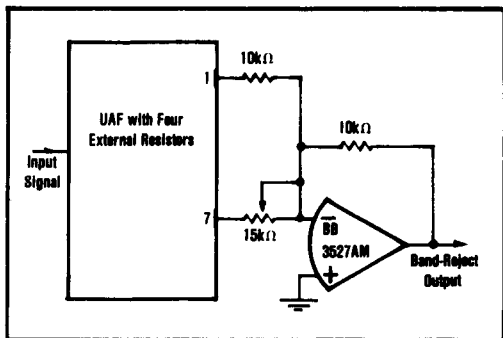

FIGURE 1. Band-Reject Configuration.

NORMALIZED LOW-PASS PARAMETERS

Usual active filter design procedure involves using normalized low-pass parameters. Table II is provided to assist in this step for the more common filter responses. Table III is a FORTRAN program which allows f_n and Q to be calculated for any desired ripple and number of poles for the Chebyshev response. Program inputs are the number of poles (N) and the peak-to-peak ripple (R). Program outputs are f_n and Q , which are used exactly as the values taken from Table II.

TABLE II. Low-Pass Filter Parameters.

Number of Poles	Butterworth		Bessel		Chebyshev			
	$f_n(f)$	Q	$f_n(f)$	Q	0.5 dB Ripple		2 dB Ripple	
					$f_n(f)$	Q	$f_n(f)$	Q
2	1.0	0.70711	1.2742	0.57735	1.23134	0.86372	0.907227	1.1286
3	1.0	—	1.32475	—	0.826456	—	0.368911	—
	1.0	1.0	1.44993	0.89104	1.068853	1.7082	0.941326	2.5516
4	1.0	0.54118	1.43241	0.52193	0.597002	0.70511	0.470711	0.9294
	1.0	1.3085	1.80694	0.80854	1.031270	2.9408	0.963678	4.58388
5	1.0	—	1.50470	—	0.362320	—	0.218306	—
	1.0	0.81805	1.55876	0.56354	0.690483	1.1778	0.827017	1.77599
6	1.0	1.81812	1.75812	0.91682	1.017735	4.5450	0.97579	7.23228
	1.0	0.61783	1.80683	0.51032	0.398229	0.68364	0.31611	0.9016
7	1.0	0.70711	1.89186	0.81120	0.788121	1.8104	0.730027	2.84426
	1.0	1.93349	1.90782	1.0233	1.011446	6.5128	0.962826	10.4616
8	1.0	—	1.68713	—	0.256170	—	0.155410	—
	1.0	0.55497	1.71911	0.53235	0.503863	1.0916	0.460853	1.64642
9	1.0	0.80192	1.82539	0.89083	0.822729	2.5755	0.797114	4.11507
	1.0	2.2472	2.05279	1.1263	1.008022	8.8418	0.967226	14.2802
10	1.0	0.50980	1.78143	0.50599	0.298736	0.87658	0.237699	0.89236
	1.0	0.80134	1.85314	0.55981	0.598874	1.6107	0.571925	2.5327
11	1.0	0.89998	1.95645	0.71085	0.861007	3.4657	0.842486	5.58354
	1.0	2.5829	2.19237	1.2257	1.006984	11.5308	0.990142	18.6873

- 3dB frequency.
- Frequency at which amplitude response passes through the ripple band.

TABLE III. Low-Pass Chebyshev Program.

```

PI=3.1415926536
COMPLEX P(10)
READ 5, N, R
5 FORMAT (I2,F8.6)
A=SQRT(EXP(R/4.3429448))-1.
B=1./A
AN=ALOG(B+SQRT(B**2.1.))
AN=AN/FLOAT(N)
J=MOD(N, 2)+N/2
DO 10K=1, J
RP=SINH(AN)*SIN(PI*FLOAT(2*K-1)/FLOAT(2*N))
XIP=COSH(AN)*COS(PI*FLOAT(2*K-1)/FLOAT(2*N))
WN=SQRT(RP**2+XIP**2)
Q=WN/(2*RP)
P(K)=CMPLX(WN,Q)
IF(MOD(N,2).NE.0.AND K.EQ.J)GO TO 15
PRINT 20, P(K)
GO TO 10
15 F=REAL(P(K))
PRINT 30, F
10 CONTINUE
20 FORMAT (2X:'FN="'E20.8'Q="'E20.8)
30 FORMAT (2X:'FN="'E20.8)
STOP
END
    
```

NOTE: Language variations between computers may require modification of this program.

Note that for bandpass and high-pass filters complex conjugate pole pairs in the actual filter correspond to single poles in the normalized low-pass model. Thus four poles in Table II would correspond to four-pole pairs in a bandpass or high-pass filter.

Filters with an odd number of poles show one f_n with no corresponding Q value. This represents a simple RC network that is required for odd pole filters. This RC network with a cutoff frequency equal to f_n times the overall filter cutoff frequency should be placed in series with the first UAF two-pole section. An external op amp and RC network can be used for this purpose.

The cutoff frequency determined by the Table II filter parameters is (1) the -3dB frequency of the Butterworth response and of the Bessel response and (2) the frequency at which the amplitude response of the Chebyshev filters passes through the maximum ripple band (to enter the stop band).

LOW-PASS TRANSFORMATION

Low-Pass to High-Pass

The following simple transformation may be used for high-pass filters:

$$f_n \text{ (high-pass)} = \frac{1}{f_n \text{ (low-pass)}}$$

$$Q \text{ (high-pass)} = Q \text{ (low-pass)}$$

Low-Pass to Bandpass

The low-pass to bandpass transformation to generate f_n (bandpass) and Q (bandpass) is much more complicated. It is tedious to do by hand but can be accomplished with the FORTRAN program given in Table IV. This program automates the transformation

$$s = p/2 \pm \sqrt{(p/2)^2 - 1}$$

TABLE IV. Low-Pass to Bandpass Transformation Program.

```

COMPLEX P,S,U
READ 5, FN, Q, QBP
5 FORMAT (3F12.5)
Y=FN*SQRT(1.-1./(Q**2))**2)
X=-FN/Q**2.)
P=CMPLX(X,Y)
U=CONJG(P)
DO 30 I=1,2
S=P/(2.*QBP)
P=S**2.-1.
T=ATAN2(AIMAG(P),REAL(P))
IF (T.GE.0.)GO TO 10
T=2.*3.14159+T
10 T=T/2.
A=SQRT(CABS(P))*COS(T)
B=SQRT(CABS(P))*SIN(T)
S=S+CMPLX(A,B)
FN=CABS(S)
Q=FN/(2.*REAL(S))
PRINT 20, FN, Q
20 FORMAT (2X*FN="F12.5"Q="F12.5)
IF(AIMAG(U).EQ.0.)GO TO 40
30 P=U
40 STOP
END

```

NOTE: Language variations between computers may require modification of this program.

Program Inputs

1. f_n - From Table II for the low-pass filter of interest
2. Q - From Table II
3. Q_{BP} - Desired Q of the bandpass filter

For filters with an odd number of poles a Q of 0.5 should be used where Q is not given in Table II. Enter 10^3 for Q when transforming zeros on the imaginary axis.

The program transforms each low-pass pole into a

would result in the pole positions for a three-pole pair bandpass filter requiring three UAF stages.

DENORMALIZATION OF PARAMETERS

Table II shows filter parameters for many 2- to 8-pole normalized low-pass filters. The Q and the normalized undamped natural frequency, f_n for each two-pole section are shown. The Q values do not have to be denormalized and may be used directly as described in the Design Procedure Summary. f_n must be denormalized by multiplying it by the desired cutoff frequency of the actual overall filter to obtain the required frequency, f_c of the design formulas. As an example, consider a 4-pole low-pass Bessel filter with a cutoff frequency of 1000Hz. The first stage would be designed to an f_c of 1432.41 Hz and a Q of 0.52193 while the second stage would have an f_c of 1605.94 Hz and Q of 0.80554. To combine the two stages into the composite filter the low-pass output of the first stage (pin 9) would be connected to the input resistors (R_G) of the second stage.

CONFIGURATION SELECTION GUIDE

It is possible to configure the UAF three different ways. Each configuration produces features that may or may not be desirable for a specific application. The selection guide in Table V is given to assist in determining the most advantageous configuration for a particular application.

UAF CONFIGURATIONS AND DESIGN EQUATIONS

Noninverting Configuration

For applications requiring a bandpass gain of 1V/V, the internal resistor R_F may be used (input at pin 14) as the gain resistor R_G ; thus, only three external resistors are needed to configure the filter.

To use equations "B" connect an 11k Ω resistor between pins 12 and 1. Use equations "B" for frequencies above 8kHz or when R_Q from equations "A" becomes a negative value.

SIMPLIFIED DESIGN EQUATIONS "A"

$f_c < 5\text{kHz}$ (UAF11) or 50kHz (UAF21)

1. $R_{F1} = R_{F2} = 10^3 / \omega_0 = 1.59 \times 10^3 / f_c$
2. $A_{BP} = Q A_{LP} = Q A_{HP}$
3. $R_Q = 10^3 / (2Q_p - A_{BP} - 1)$
4. $R_G = (2Q_p - A_{BP} + 1) 10^3 / A_{BP}$

SIMPLIFIED DESIGN EQUATIONS "B"

$f_c > 5\text{kHz}$ (UAF11) or 50kHz (UAF21)

1. $R_{F1} = R_{F2} = 3.16 \times 10^3 / \omega_0 = 5.03 \times 10^3 / f_c$
2. $A_{BP} = Q / 3.16 A_{LP} = 3.16Q A_{HP}$
3. $R_Q = 10^3 / (3.48Q_p - A_{BP} - 1)$
4. $R_G = (3.48Q_p - A_{BP} + 1) 10^3 / A_{BP}$

Inverting Configuration

SIMPLIFIED DESIGN EQUATIONS "A"

$f_c < 5\text{kHz}$ (UAF11) or 50kHz (UAF21)

1. $R_{F1} = R_{F2} = 10^3 / \omega_0 = 1.59 \times 10^3 / f_c$
2. $A_{BP} = Q A_{LP} = Q A_{HP}$
3. $R_Q = 10^3 Q_p / A_{BP}$

	NONINVERTING INPUT	INVERTING INPUT	BI-QUAD
Outputs Available	BP, LP and HP	BP, LP and HP	BP and LP
Inverted Outputs	BP	HP and LP	BP and LP
Q & Gain Independent of Frequency Resistors?	Yes	Yes	No
Type of Q Variation With Changes in R _f	Constant Q	Constant Q	Constant bandwidth
Other Advantages	May be used with only three external resistors (use internal R ₃ as R _G)		R _G and R _Q are small at high frequencies
Parameter Limitations	2Q _p - A _{BP} > 1 (f ₀ < 8kHz) 3.48Q _p - A _{BP} > 1 (f ₀ > 8kHz)	2Q _p + A _{BP} > 1 (f ₀ < 8kHz) 3.48Q _p + A _{BP} > 1 (f ₀ > 8kHz)	None
<p>Summary: The Bi-Quad filter is particularly useful as a bandpass filter if the filter bandwidth must be kept constant as the center frequency is varied. If Q must be kept constant (i.e., constant Q of a bandpass or maintaining constant response of a low-pass or high-pass) one of the other two configurations should be used. The Bi-Quad also has the advantage that R_G and R_Q are smaller than R_G and R_Q of the other two configurations (this is especially useful at high frequencies). The noninverting input configuration has the advantage that for A_{BP} = 1, R_G = 100kΩ; therefore R₃ (internal) may be used so that only three external resistors are needed (R_{f1}, R_{f2}, R_Q).</p>			

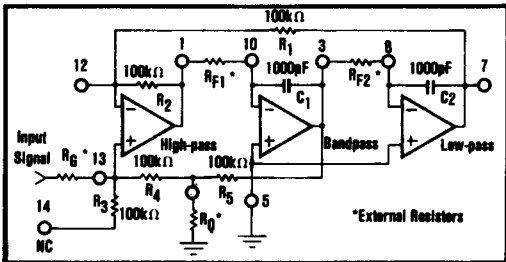

FIGURE 2. Noninverting Configuration.

SIMPLIFIED DESIGN EQUATIONS "B"

- f₀ > 5kHz (UAF11) or 50kHz (UAF21)
- 1. R_{F1} = R_{F2} = 3.16 x 10³ / ω₀ = 5.03 x 10³ / f₀
- 2. A_{BP} = Q_p/3.16 = 3.16Q_p A_{HP}
- 3. R_G = 3.16 x 10³ Q_p / A_{BP}
- 4. R_Q = 2 x 10³ / (3.48Q_p + A_{BP} - 1)

BI-QUAD Configuration

SIMPLIFIED DESIGN EQUATIONS "A"

- f₀ < 5kHz (UAF11) or 50kHz (UAF21)
- 1. R_{F1} = R_{F2} = 10³ / ω₀ = 1.59 x 10³ / f₀
- 2. Q A_{LP} = A_{BP}
- 3. R_Q = Q_p R_{F1}
- 4. R_G = R_Q / A_{BP}

SIMPLIFIED DESIGN EQUATIONS "B"

- f₀ > 5kHz (UAF11) or 50kHz (UAF21)
- 1. R_{F1} = R_{F2} = 3.16 x 10³ / ω₀ = 5.03 x 10³ / f₀
- 2. Q A_{LP} = A_{BP}
- 3. R_Q = 3.16 Q_p R_{F1}
- 4. R_G = R_Q / A_{BP}

Design Equations "A" and "B"

1. For f₀ below 8kHz, either of equations "A" or "B" may be used.
2. For f₀ above 8kHz, equations "B" must be used. If equations "A" were used above 8kHz, the filter could become unstable.
3. Equations "A" are for the UAF as it is supplied. When using equations "B", a 11kΩ resistor must be placed in parallel with R₂ (between pins 12 and 1).

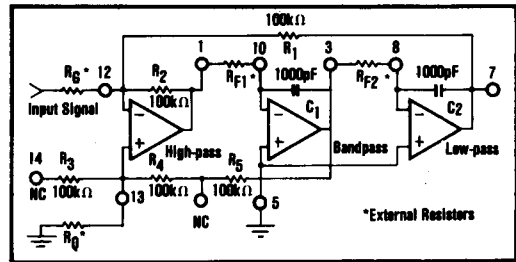

FIGURE 3. Inverting Configuration.

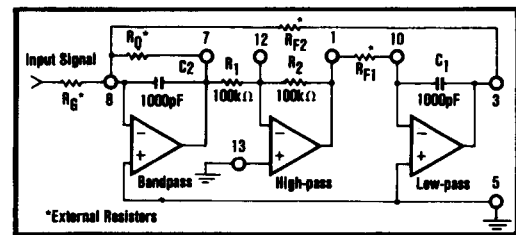

FIGURE 4. Bi-Quad Configuration.

4. The values of R_{F1} and R_{F2} calculated with equations "B" are approximately one-third of those calculated with equations "A". Thus there may be an advantage in using equations "B" at low frequencies. Using equations "B" would require use of one more resistor, but that would not alter or affect filter performance in any manner.
5. Using the negative gain values for A_{LP} or A_{HP} or A_{BP} could result in the negative values for resistors R_G and R_Q. So the absolute value of the gain should always be used in the equations.
6. Under some circumstances the value of R_Q using equations "A" will be negative. If this occurs, use design equations "B".

Natural Frequency (f₀)

1. f₀ for each one pole-pair bandpass filter is the center frequency (f_c). f_c is defined as f_c = √f₁f₂ where f₁ is the lower -3dB point and f₂ is the upper -3dB point of the pole-pair response.

- To obtain f_0 below 100Hz using practical resistor values, capacitors may be paralleled with C1 and C2 to reduce the size of R_{F1} and R_{F2} . If capacitors are added in parallel,

$$R_{F1}(\text{new}) = R_{F2}(\text{new}) = R_{F1}(\text{old}) \frac{1000\text{pF}}{C + 1000\text{pF}}$$

where $R_F(\text{new})$ is the new lower value frequency resistor, C is the value of the two external capacitors placed across C1 and C2 (between pins 10 and 3 and pins 8 and 7 and $R_{F1}(\text{old})$ is the value calculated in the simplified design equations.

Q-Factor

- For bandpass filters $Q = 3\text{dB bandwidth}$
- When designing low-pass filters of more than two poles, best results will be obtained if the two pole sections with lower Q are followed by the sections with higher Q. This will eliminate any possibility of clipping due to high gain ripple in high Q sections.

Q_p Procedure

- If the " f_0 times Q" product is greater than 10^4 (or 10^5 for the UAF21), it is possible for the measured filter Q to be different from the calculated value of Q. This effect is the result of nonideal characteristics of operational amplifiers. It can be compensated for by introducing the parameter Q_p into the design equations.
- Calculate the $f_0 Q$ product for the filter. If the product is above 10^4 Hz (or 10^5 for the UAF21), locate the corresponding $f_0 Q_p$ product on the curve in Figure 5. Divide $f_0 Q_p$ by f_0 to obtain Q_p . Use Q_p as indicated in the design equations. For $f_0 Q$ products below 10^4 Hz (or 10^5 for the UAF21), $Q_p = Q$.

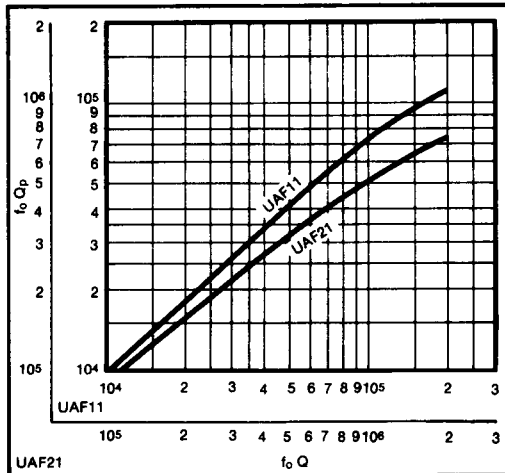

FIGURE 5. Q_p Determination.

Gain (A)

- The gain (V/V) of each filter section is:
 A_{LP} - for low-pass output - gain at DC

A_{HP} - for high-pass output - gain at high frequencies.

- Refer to the Typical Performance Curves for full power response. When selecting the gain, insure the limits of the curve are not exceeded for the desired voltage range.

DETAILED TRANSFER FUNCTION EQUATIONS

The following equations show the action of all the internal and external UAF filter components. They are not required for the regular design procedure but could be used if a detailed analysis is required.

NONINVERTING INPUT CONFIGURATION

- $\omega_0^2 = R_2 / (R_1 R_{F1} C_1 R_{F2} C_2)$
- $Q = 1 + \left(\frac{R_2}{R_1} \right) \left(\frac{R_1}{R_1 + R_2} \right) (1 + 10^9 / R_Q) \sqrt{\frac{R_2 R_{F1} C_1}{R_1 R_{F2} C_2}}$
- $R_{LP} = 10^9 + 10^9 R_Q / (10^9 + R_Q)$
- $Q A_{LP} = Q A_{HP} R_1 / R_2 = A_{HP} \sqrt{R_1 R_{F1} C_1 / (R_2 R_{F2} C_2)}$
- $A_{HP} = 10^9 (2 + 10^9 / R_Q) / R_Q$

INVERTING INPUT CONFIGURATION

- $\omega_0^2 = R_2 / (R_1 R_{F1} C_1 R_{F2} C_2)$
- $Q = R_2 (1 + 2 \times 10^9 / R_Q) \sqrt{R_{F1} C_1 / (R_1 R_2 R_{F2} C_2)}$
- $Q A_{LP} = Q R_1 A_{HP} / R_2 = A_{HP} \sqrt{R_1 R_{F1} C_1 / (R_2 R_{F2} C_2)}$
- $A_{HP} = \sqrt{R_1 R_2 R_{F2} C_2 / (R_{F1} C_1)} Q / R_1$
- $1/R_p = 1/R_1 + 1/R_2 + 1/R_Q$

BI-QUAD CONFIGURATION

- $\omega_0^2 = R_2 / (R_1 R_{F1} C_1 R_{F2} C_2)$
- $Q = R_Q C_2 \omega_0$
- $Q A_{LP} / (\omega_0 R_{F2} C_2) = A_{HP} = R_Q / R_1$

Offset Error Adjustment

DC offset errors will be minimized by grounding pin 5 through a resistor equal to 1/2 the value of R_{F1} or R_{F2} . The DC offset adjustment shown here may be used if required.

Offset errors will increase with increases in R_F .

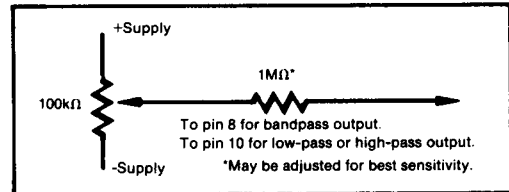

Design Example

It is desired to design a 5-pole Bessel, Low-Pass Filter with $f_0 = 3.3\text{kHz}$ and $A_{LP} = 1$. We will use the UAF11 to implement this filter.

From Table II the following values of f_0 and Q are obtained.

Complex Poles:

$$\left. \begin{aligned} f_n &= 1.55876 \\ Q &= 0.56354 \\ f_n &= 1.75812 \\ Q &= 0.91652 \end{aligned} \right\}$$

Simple Pole:

$$f_n = 1.60470$$

Using the above shown values of f_n and Q , we now will proceed to design the three stages of filter separately.

Any one of the three configurations can be used. We will select inverting configuration.

For Stage 1.

$$f_n = 3.3\text{kHz} \times f_n = 3.3\text{kHz} \times 1.55876 = 5144\text{Hz}$$

Since $f_o > 5\text{kHz}$, equations "B" would be used, thus an $11\text{k}\Omega$ resistor must be connected between pins 12 and 1.

$$R_{F1} = R_{F2} = \frac{5.03 \times 10^7}{5144} = 9778\Omega$$

$$f_o Q = 5144 \times 0.56354 = 2.9 \times 10^3$$

$$f_o Q < 10^4, \therefore Q_P = Q = 0.56354$$

$$A_{BP} = \frac{Q_P}{3.16} \quad A_{LP} = \frac{0.56354}{3.16} \times 1 = 0.17834$$

$$R_{G1} = \frac{3.16 \times 10^4 Q_P}{A_{BP}} = \frac{3.16 \times 10^4 \times 0.56354}{0.17834} = 99.85\text{k}\Omega$$

$$R_Q = \frac{2 \times 10^5}{3.48 Q_P + A_{BP} - 1} = \frac{2 \times 10^5}{3.48 \times 0.56354 + 0.17834 - 1} = 175.52\text{k}\Omega$$

For Stage 2.

$$f_n = 3.3\text{kHz} \times f_n = 3.3\text{kHz} \times 1.75812 = 5802\text{Hz}$$

Since $f_o > 5\text{kHz}$, equations "B" would again be used, and an $11\text{k}\Omega$ resistor would be connected between pins 12 and 1 of the second UAF stage.

$$R_{F1} = R_{F2} = \frac{5.03 \times 10^7}{5802} = 8669\Omega$$

$$f_o Q = 5802 \times 0.91652 = 5.32 \times 10^3$$

$$f_o Q < 10^4, \therefore Q_P = Q = 0.91652$$

$$A_{BP} = \frac{Q_P}{3.16} \quad A_{LP} = \frac{0.91652}{3.16} \times 1 = 0.29004$$

$$R_{G1} = \frac{3.16 \times 10^4 Q_P}{A_{BP}} = \frac{3.16 \times 10^4 \times 0.91652}{0.29004} = 99.86\text{k}\Omega$$

$$R_Q = \frac{2 \times 10^5}{(3.48 Q_P + A_{BP} - 1)} = \frac{2 \times 10^5}{(3.48 \times 0.91652 + 0.29004 - 1)} = 80.66\text{k}\Omega$$

For Stage 3.

$$f = 3.3\text{kHz} \times f_n = 3.3\text{kHz} \times 1.50470 = 4966\text{Hz}$$

For the simple pole,

$$RC = \frac{1}{2\pi f} = \frac{1}{2\pi \times 4966} = 3.2049 \times 10^{-5}$$

3300pF (or any convenient value)

$$R = \frac{3.2049 \times 10^{-5}}{3300 \times 10^{-12}} = 9.71\text{k}\Omega$$

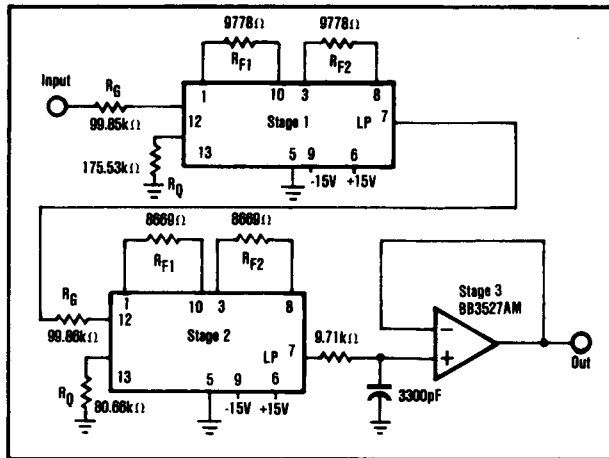

FIGURE 6. Overall Circuit.