



ULN2064B - ULN2066B
 ULN2068B - ULN2070B
 ULN2074B - ULN2076B

50V - 1.5A QUAD DARLINGTON SWITCHES

- OUTPUT CURRENT TO 1.5 A EACH DARLINGTON
- MINIMUM BREAKDOWN 50 V
- SUSTAINING VOLTAGE AT LEAST 35 V
- INTEGRAL SUPPRESSION DIODES (ULN2064B, ULN2066B, ULN2068B and ULN2070B)
- ISOLATED DARLINGTON PINOUT (ULN2074B, ULN2076B)
- VERSIONS COMPATIBLE WITH ALL POPULAR LOGIC FAMILIES

DESCRIPTION

Designed to interface logic to a wide variety of high current, high voltage loads, these devices each contain four NPN darlington switches delivering up to 1.5 A with a specified minimum breakdown of 50 V and a sustaining voltage of 35 V measured at 100 mA. The ULN2064B, ULN2066B, ULN2068B and ULN2070B contain integral suppression diodes for inductive loads have common emitters. The ULN2074B and ULN2076B feature isolated darlington pinouts and are intended for applications such as emitter follower configurations. Inputs of the ULN2064B, ULN2068B and ULN2074B are compatible with popular 5 V logic families and the ULN2066B and ULN2076B are compatible with 6-15 V CMOS and PMOS. Types ULN2068B and ULN2070B include a predriver stage to reduce loading on the control logic.

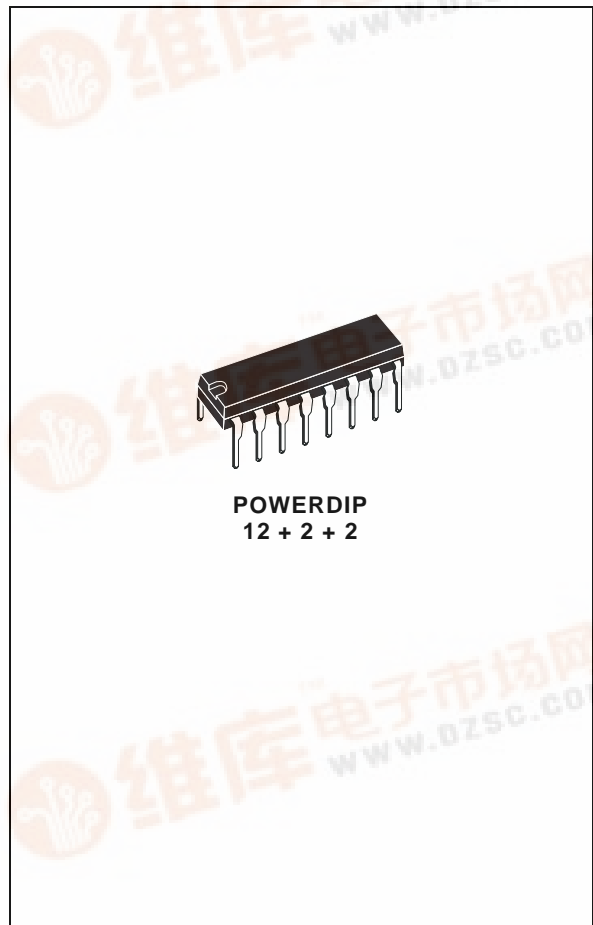

PIN CONNECTIONS AND ORDER CODES

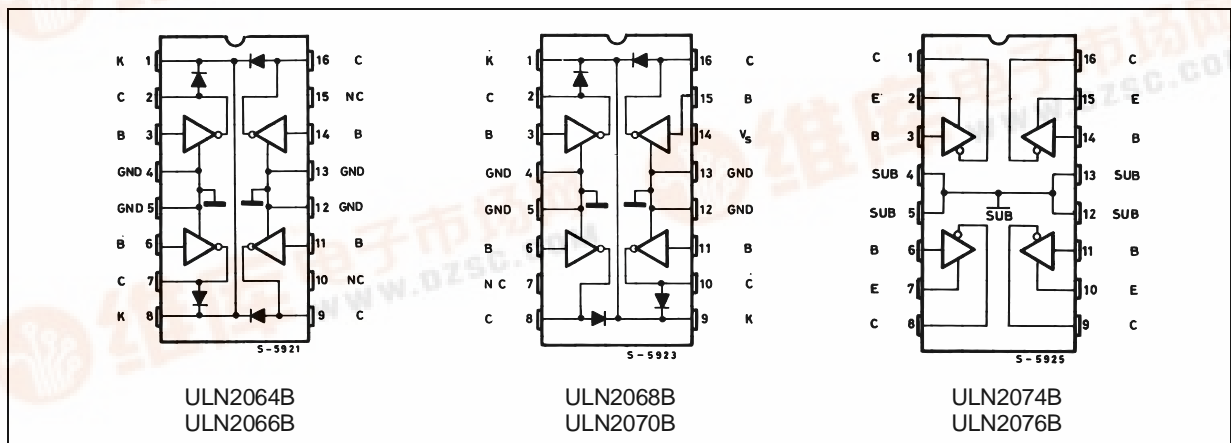

ULN2064B-ULN2066B-ULN2068B-ULN2070B-ULN2074B-ULN2076B

SCHEMATIC DIAGRAM

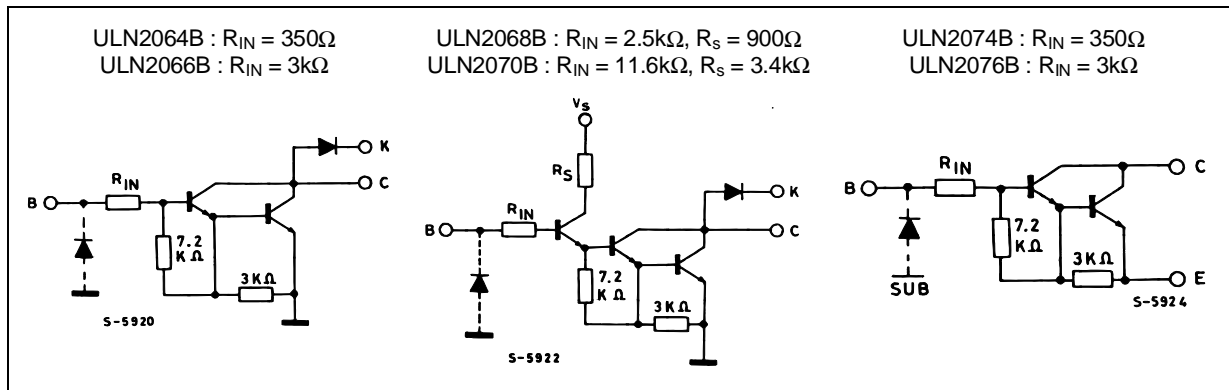

ABSOLUTE MAXIMUM RATINGS

Symbol	Parameter	Value	Unit
V_{CEX}	Output Voltage	50	V
$V_{CE(sus)}$	Output Sustaining Voltage	35	V
I_O	Output Current	1.75	A
V_i	Input Voltage	30 15	V V
	for ULN2066B – 2070B - 2074B - 2076B for ULN2064B – 2068B		
I_i	Input Current	25	mA
V_s	Supply Voltage	10 20	V V
	for ULN2068B for ULN2070B		
P_{tot}	Power Dissipation	4.3 1	W W
	at $T_{pins} = 90\text{ }^\circ\text{C}$ at $T_{amb} = 70\text{ }^\circ\text{C}$		
T_{amb}	Operating Ambient Temperature Range	- 20 to 85	$^\circ\text{C}$
T_{stg}	Storage Temperature	- 55 to 150	$^\circ\text{C}$

ELECTRICAL CHARACTERISTICS ($T_{amb} = 25^\circ\text{C}$ unless otherwise specified)

Symbol	Parameter	Test Conditions	Min.	Typ.	Max.	Unit	Fig.
I_{CEX}	Output Leakage Current	$V_{CE} = 50\text{V}$ $T_{amb} = 25^\circ\text{C}$ $T_{amb} = 70^\circ\text{C}$			100 500	μA μA	1
$V_{CE(sus)}$	Collector-emitter Sustaining Voltage	$I_C = 100\text{mA}$, $V_i = 0.4\text{V}$	35			V	2
$V_{CE(sat)}$	Collector-emitter Saturation Voltage	$I_C = 500\text{mA}$ $I_B = 625\mu\text{A}$ $I_C = 750\text{mA}$ $I_B = 935\mu\text{A}$ $I_C = 1\text{A}$ $I_B = 1.25\text{mA}$ $I_C = 1.25\text{A}$ $I_B = 2\text{mA}$			1.1 1.2 1.3 1.4	V V V V	3 3 3 3
$I_{i(on)}$	Input Current	for ULN2064B and ULN2074B $V_i = 2.4\text{V}$ $V_i = 3.75\text{V}$ for ULN2066B and ULN2076B $V_i = 5\text{V}$ $V_i = 12\text{V}$ for ULN2068B $V_i = 2.75\text{V}$ $V_i = 3.75\text{V}$ for ULN2070B $V_i = 5\text{V}$ $V_i = 12\text{V}$	1.4 3.3		4.3 9.6	mA mA	4 4
			0.6 1.7		1.8 5.2	mA mA	4 4
					0.55 1.0	mA mA	4 4
					0.4 1.25	mA mA	4 4

ULN2064B-ULN2066B-ULN2068B-ULN2070B-ULN2074B-ULN2076B

ELECTRICAL CHARACTERISTICS ($T_{amb} = 25^{\circ}\text{C}$ unless otherwise specified) (continued)

Symbol	Parameter	Test Conditions	Min.	Typ.	Max.	Unit	Fig.	
$V_{i(on)}$	Input Voltage	$V_{CE} = 2\text{V}, I_C = 1\text{A}$			2	V	5	
		ULN2064B, ULN2074B			6.5	V	5	
		ULN2066B, ULN2076B						
		$V_{CE} = 2\text{V}, I_C = 1.5\text{A}$			2.5	V	5	
		ULN2064B, ULN2074B			10	V	5	
I_s	Supply Current	for ULN2068B $I_C = 500\text{mA}, V_i = 2.75\text{V}$			6	mA	8	
		for ULN2070B $I_C = 500\text{mA}, V_i = 5\text{V}$			4.5	mA	8	
t_{PLH}	Turn-on Delay Time	$0.5 V_i$ to $0.5 V_o$			1	μs		
t_{PHL}	Turn-off Delay Time	$0.5 V_i$ to $0.5 V_o$			1.5	μs		
I_R	Clamp Diode Leakage Current	for ULN2064B-ULN2066B and ULN2068B-ULN2070B $V_R = 50\text{V}$ $T_{amb} = 25^{\circ}\text{C}$ $T_{amb} = 70^{\circ}\text{C}$			50 100	μA μA	6	
V_F	Clamp Diode Forward Voltage	for ULN2064B-ULN2066B and ULN2068B-ULN2070B $I_F = 1\text{A}$ $I_F = 1.5\text{A}$			1.75 2	V V	7	

- Notes :**
- Input voltage is with reference to the substrate (no connection to any other pins) for the ULN2074B and ULN2076B reference is ground for all other types.
 - Input current may be limited by maximum allowable input voltage.

TEST CIRCUITS

Figure 1.

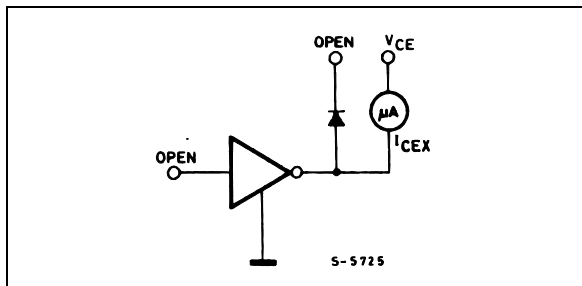

Figure 2.

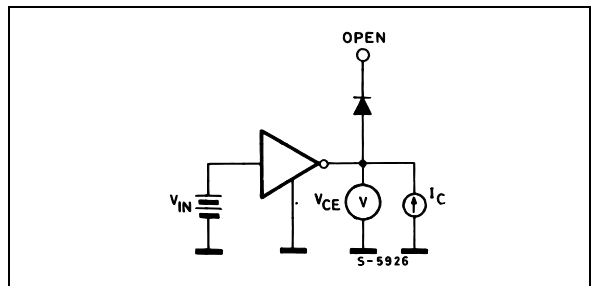

Figure 3.

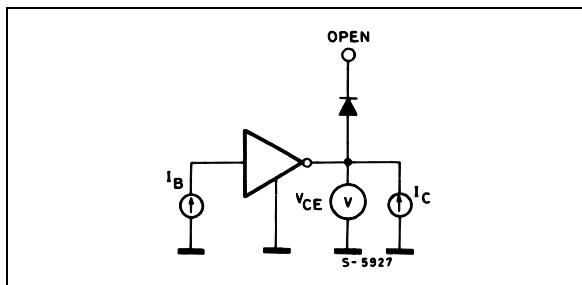

Figure 4.

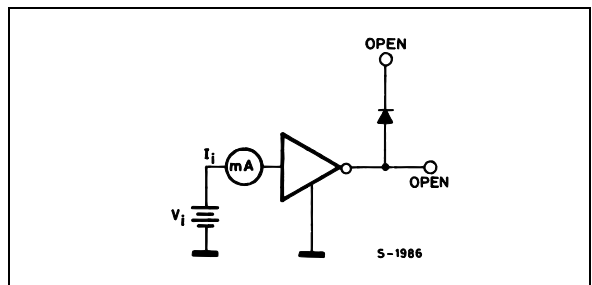

Figure 5.

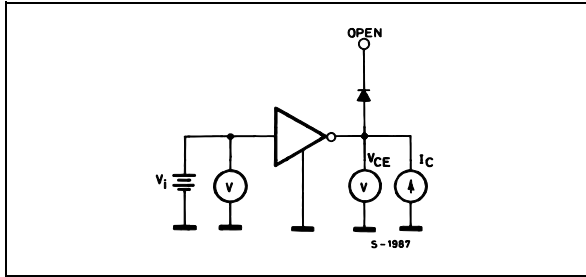

Figure 6.

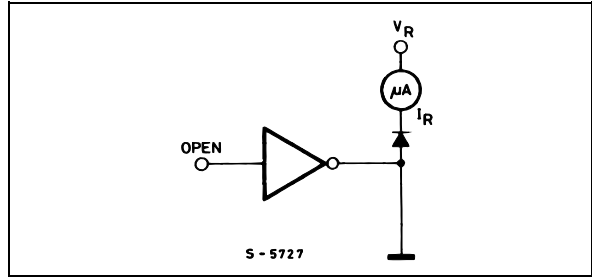

Figure 7.

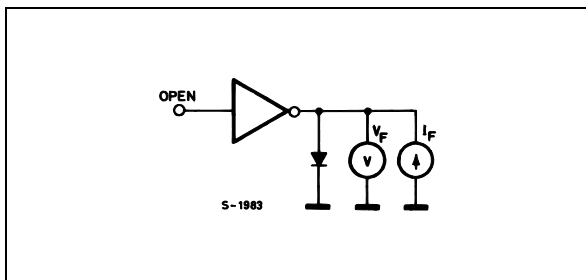

Figure 8.

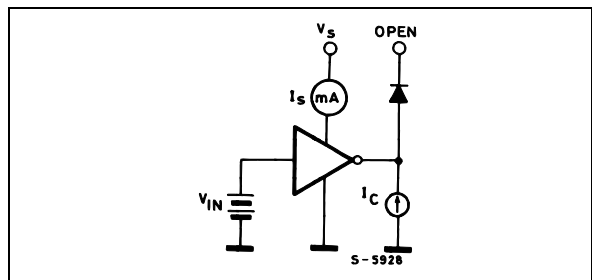

Figure 9 : Input Current as a Function of Input Voltage.

Figure 10 : Input Current as a Function of Input Voltage.

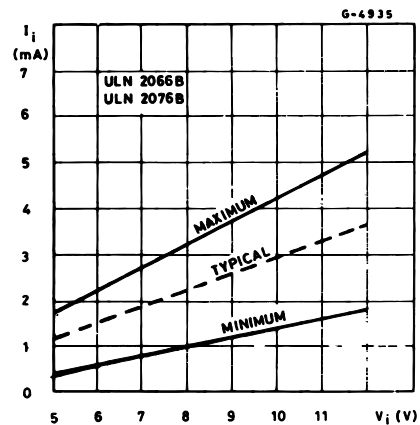
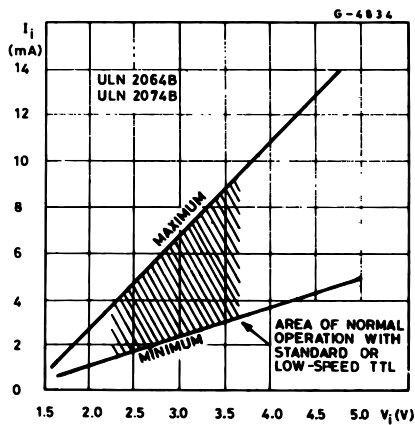
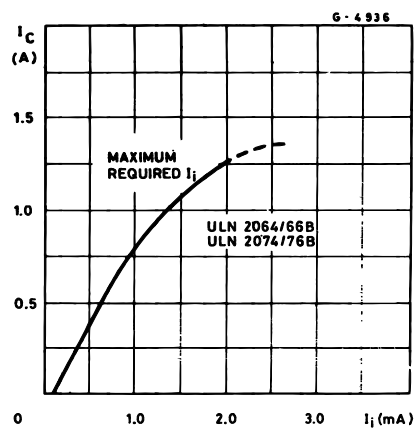

Figure 11 : Collector Current as a Function of Input Current.



MOUNTING INSTRUCTIONS

The $R_{th\ j-amb}$ can be reduced by soldering the GND pins to a suitable copper area of the printed circuit board (Fig. 12) or to an external heatsink (Fig. 13). The diagram of Figure 14 shows the maximum dissipable power P_{tot} and the $R_{th\ j-amb}$ as a function of the side "α" of two equal square copper areas having a thickness of $35\ \mu$ (1.4 mils).

During soldering the pins temperature must not exceed $260\ ^\circ\text{C}$ and the soldering time must not be longer than 12 seconds.

The external heatsink or printed circuit copper area must be connected to electrical ground.

Figure 12 : Example of P.C. Board Area which is Used as Heatsink.

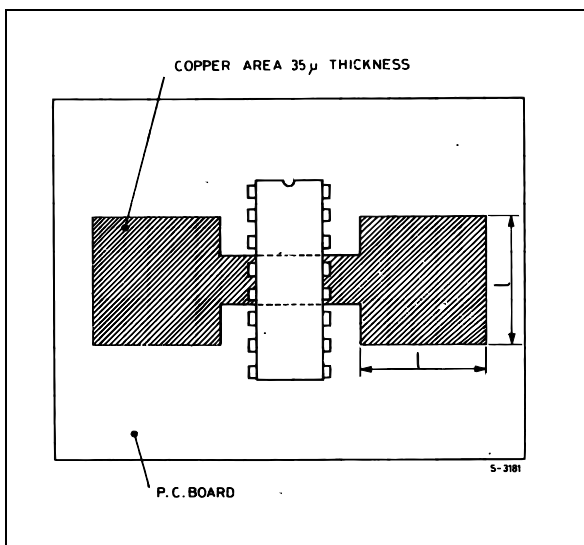

Figure 13 : External Heatsink Mounting Example.

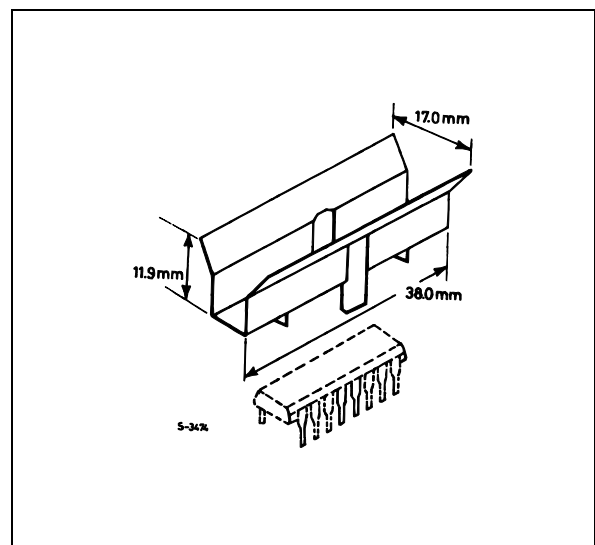

Figure 14 : Maximum Dissipable Power and Junction to Ambient Thermal Resistance vs. Side "α".

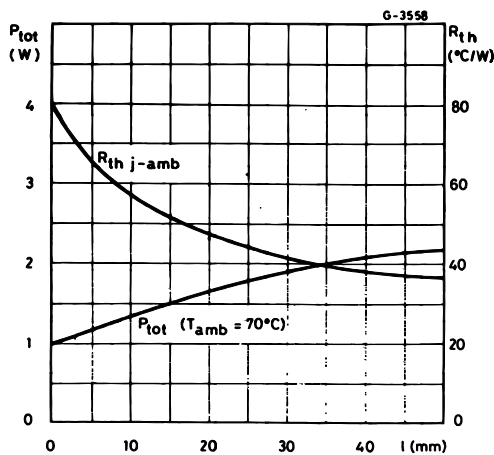
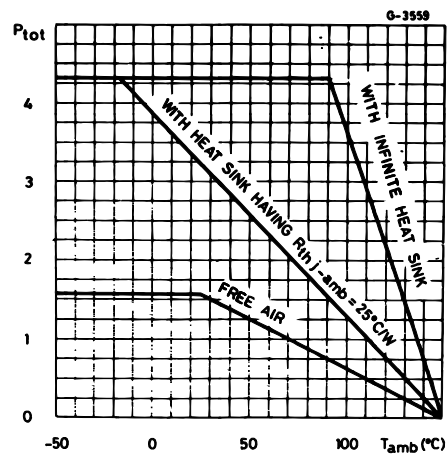

Figure 15 : Maximum Allowable Power Dissipation vs. Ambient Temperature.



TYPICAL APPLICATIONS

Figure 16 : Common-anode LED Drivers.

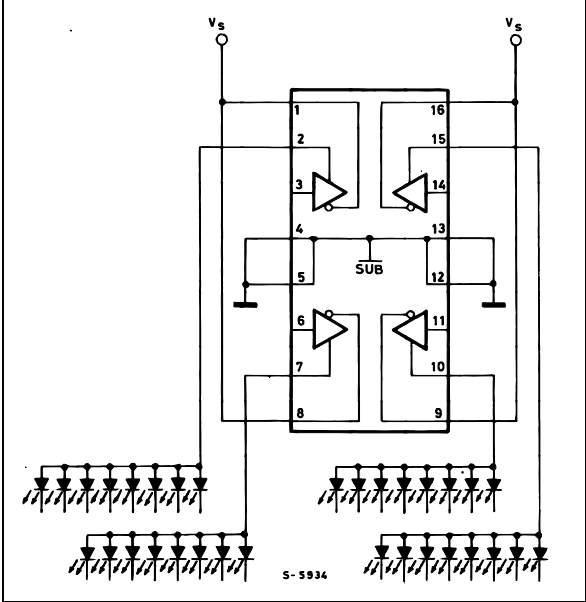
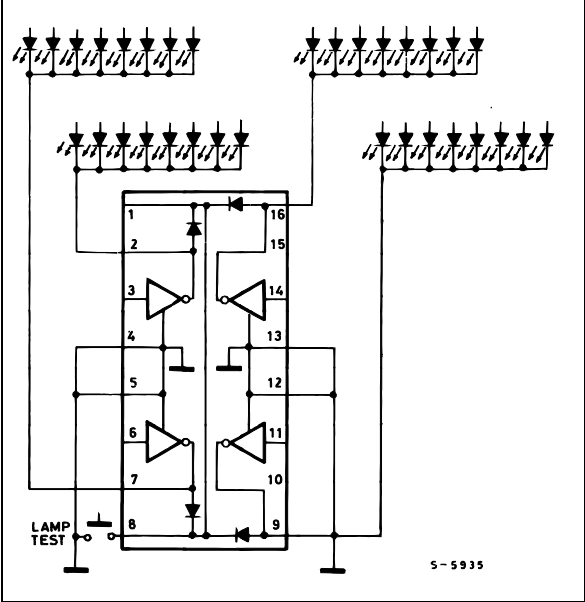

Figure 17 : Common-cathode LED Drivers.



ULN2064B-ULN2066B-ULN2068B-ULN2070B-ULN2074B-ULN2076B

DIM.	mm			inch		
	MIN.	TYP.	MAX.	MIN.	TYP.	MAX.
a1	0.51			0.020		
B	0.85		1.40	0.033		0.055
b		0.50			0.020	
b1	0.38		0.50	0.015		0.020
D			20.0			0.787
E		8.80			0.346	
e		2.54			0.100	
e3		17.78			0.700	
F			7.10			0.280
I			5.10			0.201
L		3.30			0.130	
Z			1.27			0.050

OUTLINE AND MECHANICAL DATA

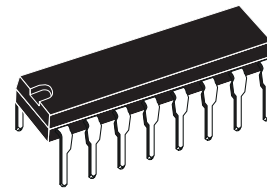

Powerdip 16

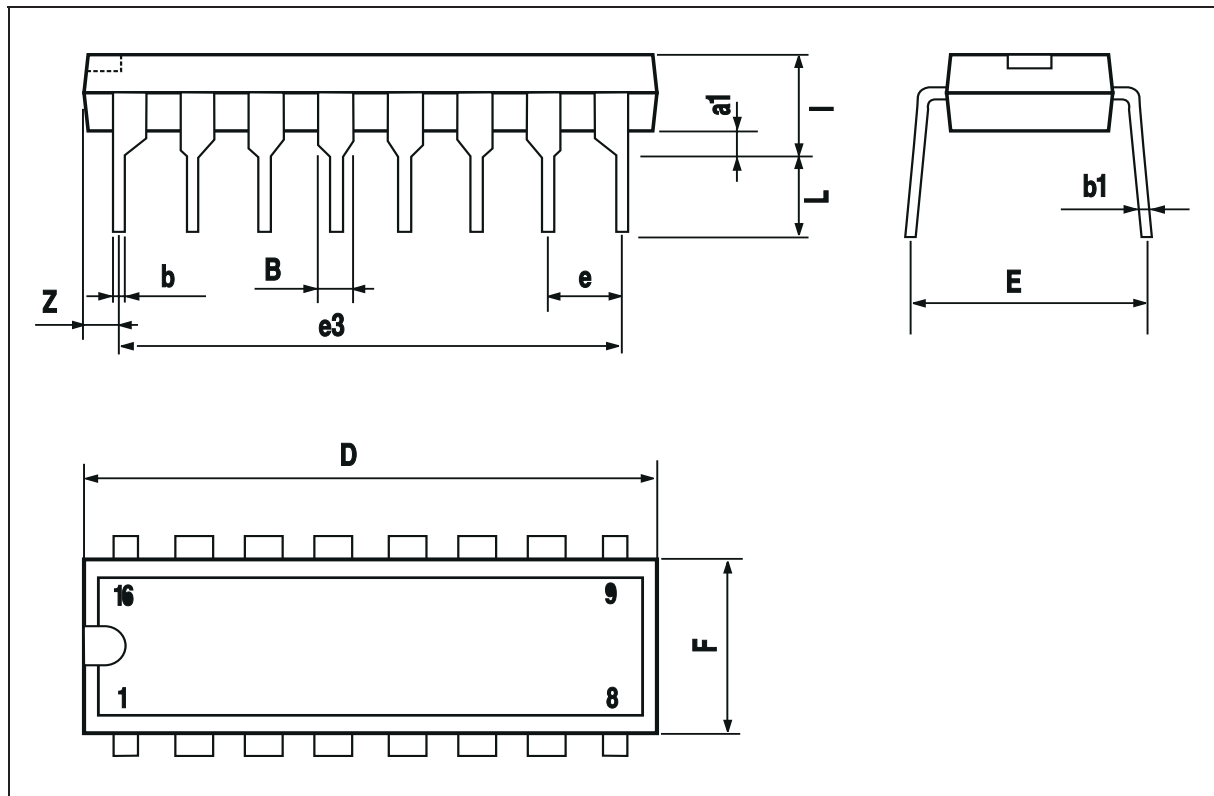

Information furnished is believed to be accurate and reliable. However, STMicroelectronics assumes no responsibility for the consequences of use of such information nor for any infringement of patents or other rights of third parties which may result from its use. No license is granted by implication or otherwise under any patent or patent rights of STMicroelectronics. Specifications mentioned in this publication are subject to change without notice. This publication supersedes and replaces all information previously supplied. STMicroelectronics products are not authorized for use as critical components in life support devices or systems without express written approval of STMicroelectronics.

The ST logo is a registered trademark of STMicroelectronics.
All other names are the property of their respective owners

© 2003 STMicroelectronics - All rights reserved

STMicroelectronics GROUP OF COMPANIES

Australia – Belgium - Brazil - Canada - China – Czech Republic - Finland - France - Germany - Hong Kong - India - Israel - Italy - Japan - Malaysia - Malta - Morocco - Singapore - Spain - Sweden - Switzerland - United Kingdom - United States
www.st.com