

NEC

MOS FIELD EFFECT POWER TRANSISTORS
μPA1703

SWITCHING
N-CHANNEL POWER MOS FET
INDUSTRIAL USE

DESCRIPTION

This product is N-Channel MOS Field Effect Transistor designed for power management applications of notebook computers.

FEATURES

- Super Low On-Resistance
 $R_{DS(on)1} = 10.5 \text{ m}\Omega$ MAX. ($V_{GS} = 10 \text{ V}$, $I_D = 5.0 \text{ A}$)
 $R_{DS(on)2} = 17 \text{ m}\Omega$ MAX. ($V_{GS} = 4 \text{ V}$, $I_D = 5.0 \text{ A}$)
- Low C_{iss} $C_{iss} = 2180 \text{ pF}$ TYP.
- Built-in G-S Protection Diode
- Small and Surface Mount Package (Power SOP8)

PACKAGE DIMENSIONS
(in millimeter)

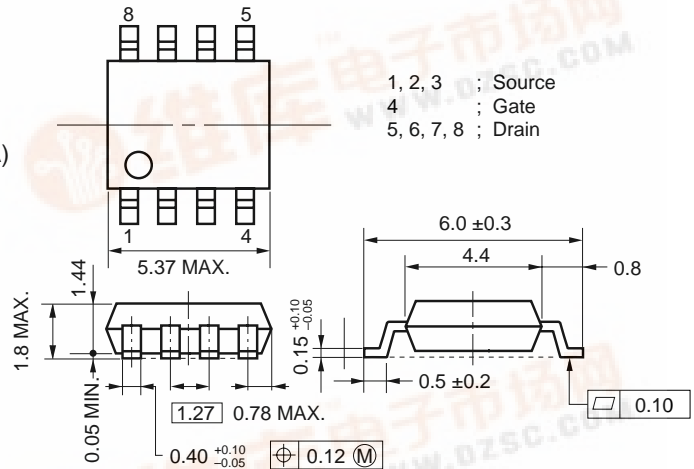

ABSOLUTE MAXIMUM RATINGS ($T_A = 25 \text{ }^\circ\text{C}$, all terminals are connected)

Drain to Source Voltage	V_{DS}	30	V
Gate to Source Voltage	V_{GS}	± 20	V
Drain Current (DC)	$I_{D(DC)}$	± 10	A
Drain Current (pulse) ^{Notes1}	$I_{D(pulse)}$	± 40	A
Total Power Dissipation ($T_A = 25 \text{ }^\circ\text{C}$) ^{Notes2}	P_T	2.0	W
Channel Temperature	T_{ch}	150	$^\circ\text{C}$
Storage Temperature	T_{stg}	-55 to +150	$^\circ\text{C}$

- Notes 1.** $PW \leq 10 \mu\text{s}$, Duty Cycle $\leq 1 \%$
2. Mounted on ceramic substrate of $1200 \text{ mm}^2 \times 0.7 \text{ mm}$

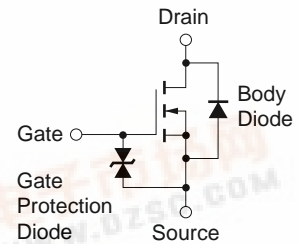

The diode connected between the gate and source of the transistor serves as a protector against ESD. When this device acutally used, an additional protection circuit is externally required if voltage exceeding the rated voltage may be applied to this device.

ELECTRICAL CHARACTERISTICS (T_A = 25 °C, all terminals are connected)

CHARACTERISTICS	SYMBOL	TEST CONDITIONS	MIN.	TYP.	MAX.	UNIT
Drain to Source On-state Resistance	R _{DS(on)1}	V _{GS} = 10 V, I _D = 5.0 A		8.5	10.5	mΩ
	R _{DS(on)2}	V _{GS} = 4 V, I _D = 5.0 A		12	17	mΩ
Gate to Source Cutoff Voltage	V _{GS(off)}	V _{DS} = 10 V, I _D = 1 mA	1.0	1.6	2.0	V
Forward Transfer Admittance	y _{fs}	V _{DS} = 10 V, I _D = 5.0 A	8.0	18		S
Drain Leakage Current	I _{DSS}	V _{DS} = 30 V, V _{GS} = 0			10	μA
Gate to Source Leakage Current	I _{GSS}	V _{GS} = ±20 V, V _{DS} = 0			±10	μA
Input Capacitance	C _{iss}	V _{DS} = 10 V		2180		pF
Output Capacitance	C _{oss}	V _{GS} = 0		890		pF
Reverse Transfer Capacitance	C _{rss}	f = 1 MHz		370		pF
Turn-On Delay Time	t _{d(on)}	I _D = 5.0 A		25		ns
Rise Time	t _r	V _{GS(on)} = 10 V		210		ns
Turn-Off Delay Time	t _{d(off)}	V _{DD} = 15 V		120		ns
Fall Time	t _f	R _G = 10 Ω		75		ns
Total Gate Charge	Q _G	I _D = 10 A		40		nC
Gate to Source Charge	Q _{GS}	V _{DD} = 24 V		5.6		nC
Gate to Drain Charge	Q _{GD}	V _{GS} = 10 V		9.6		nC
Body Diode Forward Voltage	V _{F(S-D)}	I _F = 10 A, V _{GS} = 0		0.73		V
Reverse Recovery Time	t _{rr}	I _F = 10 A, V _{GS} = 0		46		ns
Reverse Recovery Charge	Q _{rr}	di/dt = 100 A/μs		45		nC

Test Circuit 1 Switching Time

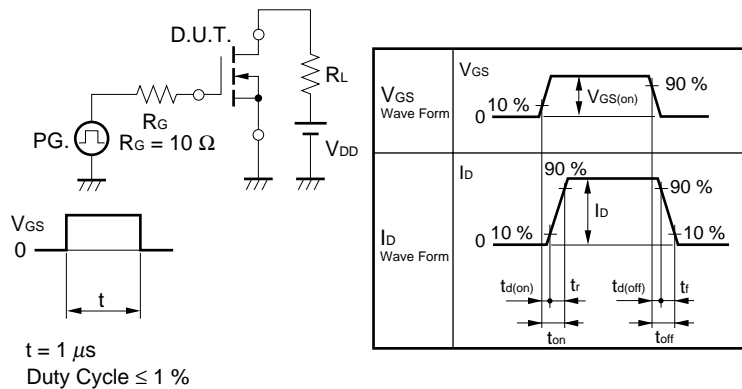

Test Circuit 2 Gate Charge

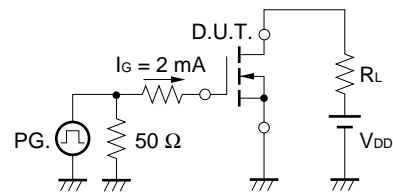

DERATING FACTOR OF FORWARD BIAS SAFE OPERATING AREA

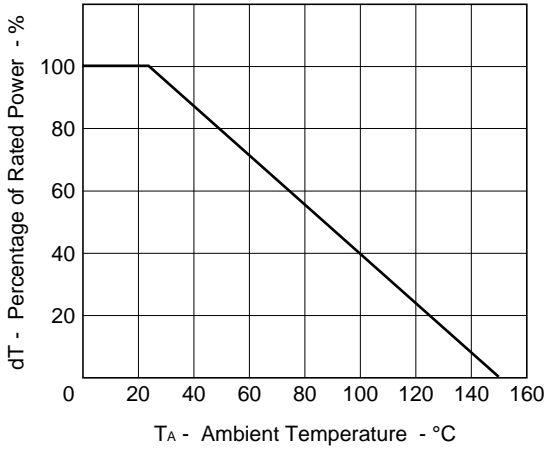

TOTAL POWER DISSIPATION vs. AMBIENT TEMPERATURE

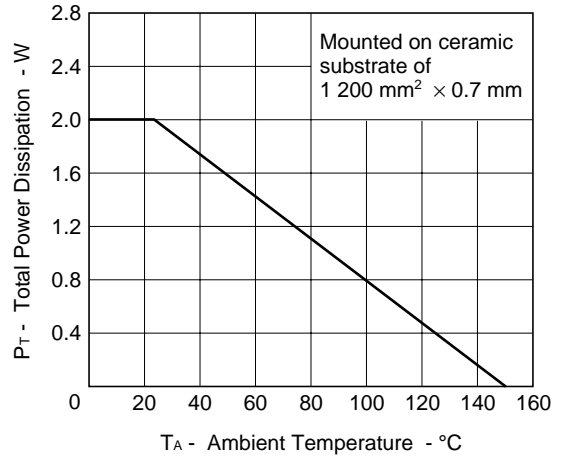

FORWARD BIAS SAFE OPERATING AREA

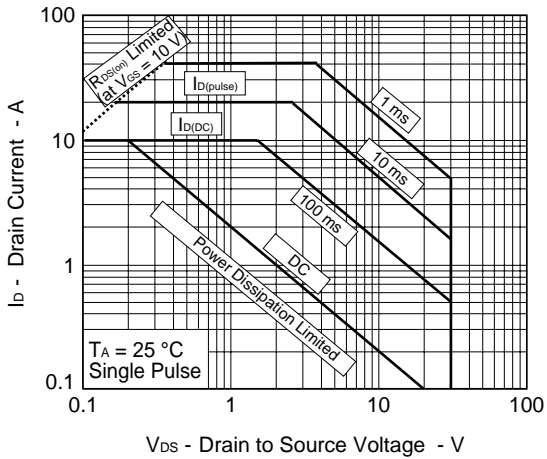

Note:
Mounted on ceramic substrate of 1 200 mm² × 0.7 mm

TRANSIENT THERMAL RESISTANCE vs. PULSE WIDTH

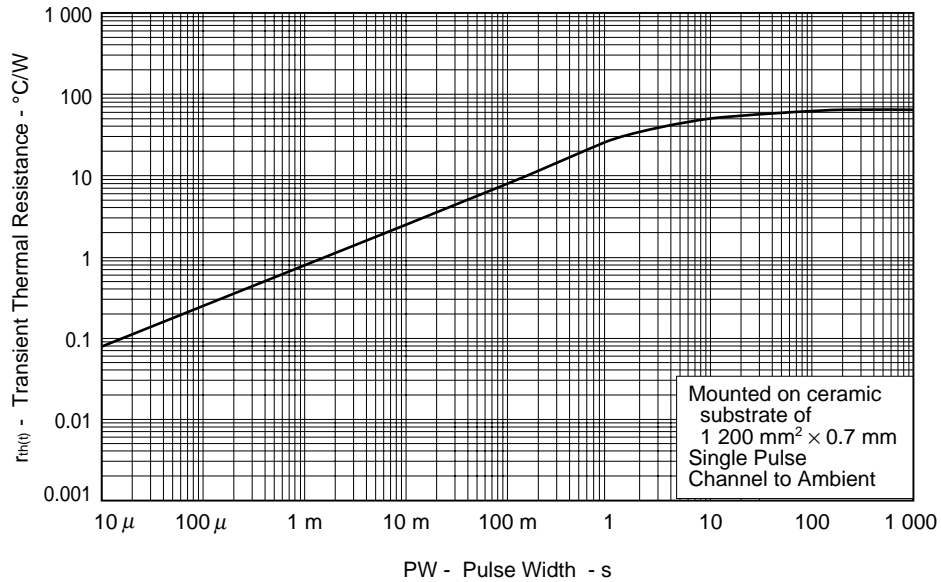

FORWARD TRANSFER CHARACTERISTICS

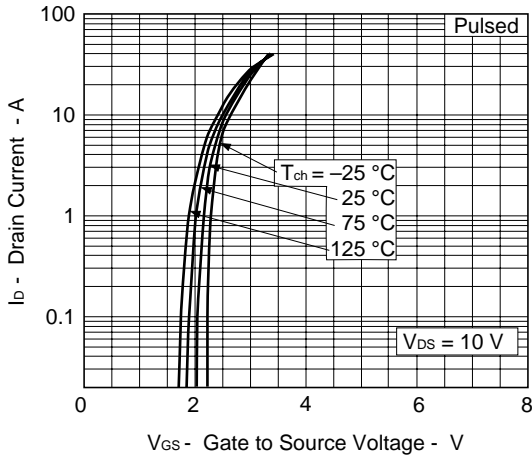

DRAIN CURRENT vs. DRAIN TO SOURCE VOLTAGE

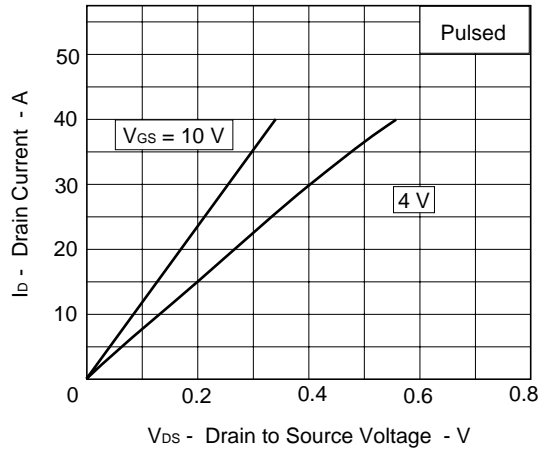

FORWARD TRANSFER ADMITTANCE vs. DRAIN CURRENT

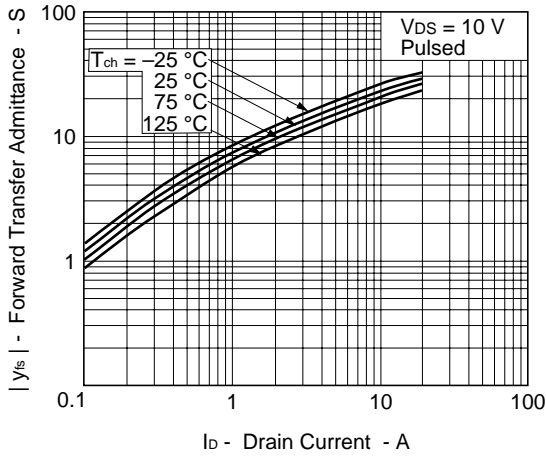

DRAIN TO SOURCE ON-STATE RESISTANCE vs. GATE TO SOURCE VOLTAGE

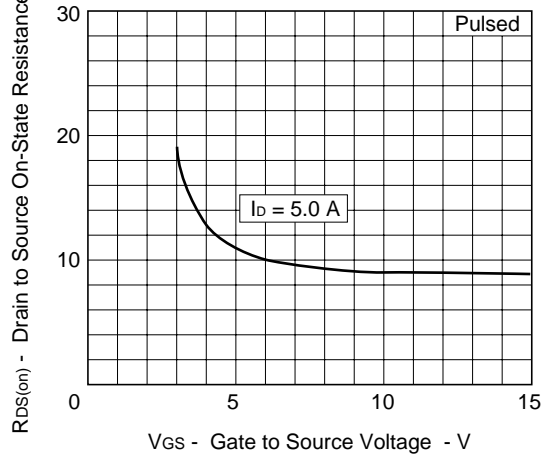

DRAIN TO SOURCE ON-STATE RESISTANCE vs. DRAIN CURRENT

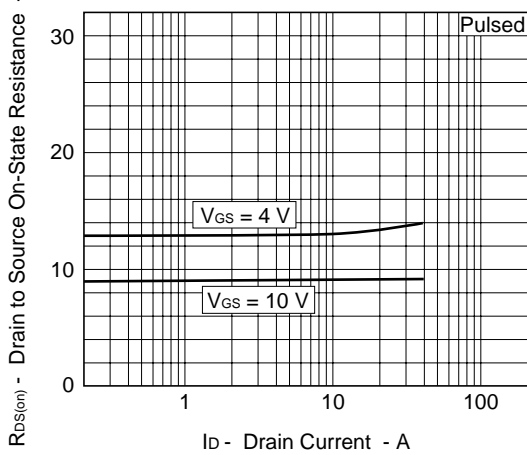

GATE TO SOURCE CUTOFF VOLTAGE vs. CHANNEL TEMPERATURE

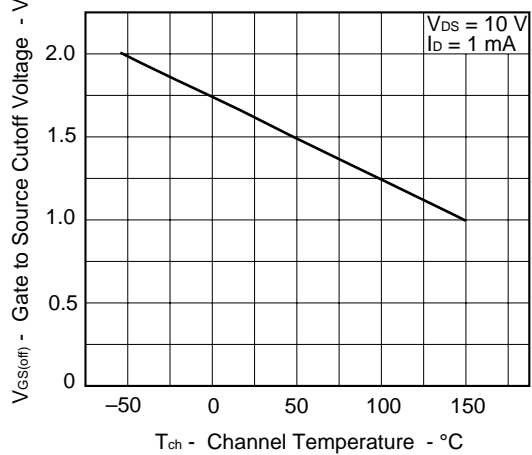

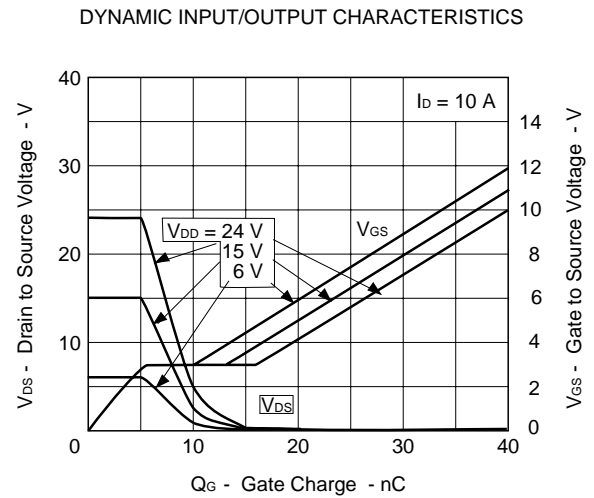
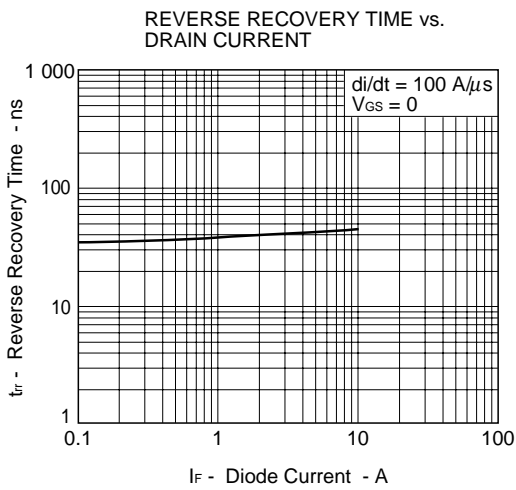
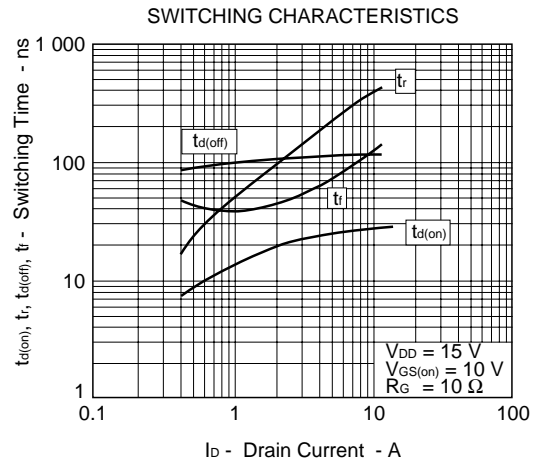
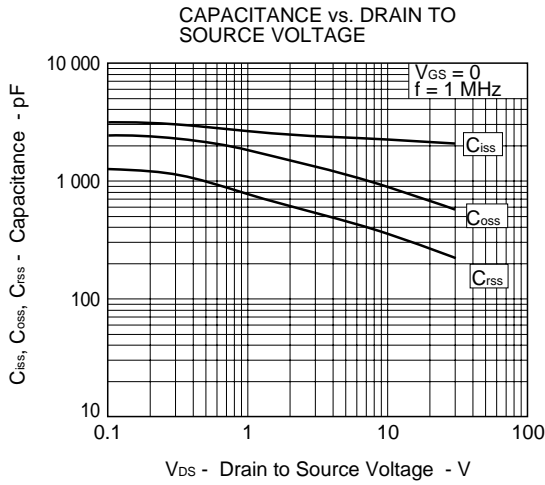
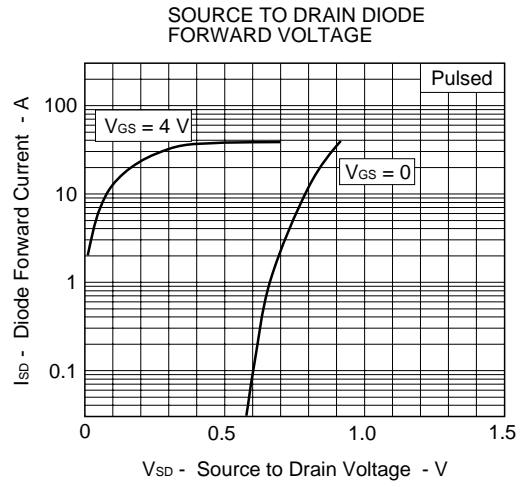
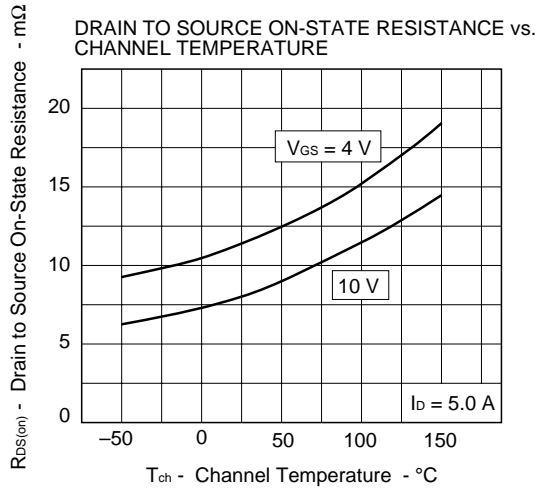

REFERENCE

Document Name	Document No.
NEC semiconductor device reliability/quality control system	C11745E
Quality grade on NEC semiconductor devices	C11531E
Semiconductor device mounting technology manual	C10535E
Semiconductor device package manual	C10943X
Guide to quality assurance for semiconductor devices	MEI-1202
Application circuits using Power MOS FET	TEA-1035
Safe operating area of Power MOS FET	TEA-1037

[MEMO]