



# BIPOLAR ANALOG INTEGRATED CIRCUIT UPC3225TB

## 5 V, SILICON GERMANIUM MMIC MEDIUM OUTPUT POWER AMPLIFIER

### DESCRIPTION

The  $\mu$ PC3225TB is a silicon germanium (SiGe) monolithic integrated circuits designed as IF amplifier for DBS tuners. This IC is manufactured using our 50 GHz  $f_{max}$  UHS2 (Ultra High Speed Process) SiGe bipolar process.

### FEATURES

- Wideband response :  $f_u = 2.8$  GHz TYP. @ 3 dB bandwidth
- Low current :  $I_{CC} = 24.5$  mA TYP.
- Medium output power :  $P_{O(sat)} = +15.5$  dBm TYP. @  $f = 0.95$  GHz  
:  $P_{O(sat)} = +12.5$  dBm TYP. @  $f = 2.15$  GHz
- High linearity :  $P_{O(1dB)} = +9.0$  dBm TYP. @  $f = 0.95$  GHz  
:  $P_{O(1dB)} = +7.0$  dBm TYP. @  $f = 2.15$  GHz
- Power gain :  $G_P = 32.5$  dB TYP. @  $f = 0.95$  GHz  
:  $G_P = 33.5$  dB TYP. @  $f = 2.15$  GHz
- Noise Figure :  $NF = 3.7$  dB TYP. @  $f = 0.95$  GHz  
:  $NF = 3.7$  dB TYP. @  $f = 2.15$  GHz
- Supply voltage :  $V_{CC} = 4.5$  to  $5.5$  V
- Port impedance : input/output  $50 \Omega$

### APPLICATIONS

- IF amplifiers in LNB for DBS converters etc.

### ORDERING INFORMATION

Part Number	Order Number	Package	Marking	Supplying Form
$\mu$ PC3225TB-E3	$\mu$ PC3225TB-E3-A	6-pin super minimold (Pb-Free) <sup>Note</sup>	C3M	Embossed tape 8 mm wide. 1, 2, 3 pins face the perforation side of the tape. Qty 3 kpcs/reel.

**Note** With regards to terminal solder (the solder contains lead) plated products (conventionally plated), contact your nearby sales office.

**Remark** To order evaluation samples, please contact your nearby sales office  
Part number for sample order:  $\mu$ PC3225TB.

**Caution** Observe precautions when handling because these devices are sensitive to electrostatic discharge.

The information in this document is subject to change without notice. Before using this document, please confirm that this is the latest version.



**PIN CONNECTIONS**

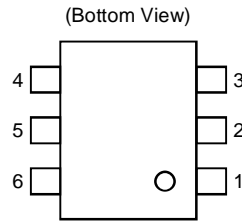
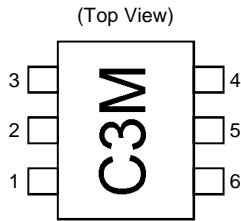

Pin No.	Pin Name
1	OUTPUT
2	GND
3	V <sub>CC</sub>
4	INPUT
5	GND
6	GND

**PRODUCT LINE-UP OF 5 V-BIAS SILICON MMIC MEDIUM OUTPUT POWER AMPLIFIER**  
 (T<sub>A</sub> = +25°C, f = 1 GHz, V<sub>CC</sub> = V<sub>out</sub> = 5.0 V, Z<sub>S</sub> = Z<sub>L</sub> = 50 Ω)

Part No.	f <sub>u</sub> (GHz)	P <sub>O(sat)</sub> (dBm)	G <sub>P</sub> (dB)	NF (dB)	I <sub>CC</sub> (mA)	Package	Marking
μPC2708TB	2.9	+10.0	15	6.5	26	6-pin super minimold	C1D
μPC2709TB	2.3	+11.5	23	5.0	25		C1E
μPC2710TB	1.0	+13.5	33	3.5	22		C1F
μPC2776TB	2.7	+8.5	23	6.0	25		C2L
μPC3223TB	3.2	+12.0	23	4.5	19		C3J
μPC3225TB	2.8	+15.5 <sup>Note</sup>	32.5 <sup>Note</sup>	3.7 <sup>Note</sup>	24.5		C3M

**Note** f = 0.95 GHz

**Remark** Typical performance. Please refer to **ELECTRICAL CHARACTERISTICS** in detail.

**PIN EXPLANATION**

Pin No.	Pin Name	Applied Voltage (V)	Pin Voltage (V) <sup>Note</sup>	Function and Applications
4	INPUT	–	0.98	Signal input pin. A internal matching circuit, configured with resistors, enables 50 Ω connection over a wide band. A multi-feedback circuit is designed to cancel the deviations of h <sub>FE</sub> and resistance. This pin must be coupled to signal source with capacitor for DC cut.
1	OUTPUT	Voltage as same as V <sub>cc</sub> through external inductor	–	Signal output pin. The inductor must be attached between V <sub>cc</sub> and output pins to supply current to the internal output transistors.
3	V <sub>cc</sub>	4.5 to 5.5	–	Power supply pin. Which biases the internal input transistor. This pin should be externally equipped with bypass capacitor to minimize its impedance.
2 5 6	GND	0	–	Ground pin. This pin should be connected to system ground with minimum inductance. Ground pattern on the board should be formed as wide as possible. All the ground pins must be connected together with wide ground pattern to decrease impedance defference.

**Note** Pin voltage is measured at V<sub>cc</sub> = 5.0 V

**ABSOLUTE MAXIMUM RATINGS**

Parameter	Symbol	Conditions	Ratings	Unit
Supply Voltage	V <sub>CC</sub>	T <sub>A</sub> = +25°C, Pin 1 and 3	6	V
Total Circuit Current	I <sub>CC</sub>	T <sub>A</sub> = +25°C	45	mA
Power Dissipation	P <sub>D</sub>	T <sub>A</sub> = +85°C <b>Note</b>	270	mW
Operating Ambient Temperature	T <sub>A</sub>		-40 to +85	°C
Storage Temperature	T <sub>stg</sub>		-55 to +150	°C
Input Power	P <sub>in</sub>	T <sub>A</sub> = +25°C	0	dBm

**Note** Mounted on double-sided copper-clad 50 × 50 × 1.6 mm epoxy glass PWB

**RECOMMENDED OPERATING RANGE**

Parameter	Symbol	Conditions	MIN.	TYP.	MAX.	Unit
Supply Voltage	V <sub>CC</sub>	The same voltage should be applied to pin 1 and 3.	4.5	5.0	5.5	V
Operating Ambient Temperature	T <sub>A</sub>		-40	+25	+85	°C

**ELECTRICAL CHARACTERISTICS (T<sub>A</sub> = +25°C, V<sub>CC</sub> = V<sub>out</sub> = 5.0 V, Z<sub>S</sub> = Z<sub>L</sub> = 50 Ω)**

Parameter	Symbol	Test Conditions	MIN.	TYP.	MAX.	Unit
Circuit Current	I <sub>CC</sub>	No input signal	20.0	24.5	31.0	mA
Power Gain	G <sub>P</sub>	f = 0.95 GHz, P <sub>in</sub> = -35.0 dBm	30.0	32.5	35.0	dB
		f = 2.15 GHz, P <sub>in</sub> = -35.0 dBm	30.5	33.5	36.0	
Saturated Output Power	P <sub>O(sat)</sub>	f = 0.95 GHz, P <sub>in</sub> = □5.0 dBm	+13.5	+15.5	-	dBm
		f = 2.15 GHz, P <sub>in</sub> = □5.0 dBm	+10.5	+12.5	-	
Gain 1 dB Compression Output Power	P <sub>O(1 dB)</sub>	f = 0.95 GHz	+7.0	+9.0	-	dBm
		f = 2.15 GHz	+5.0	+7.0	-	
Noise Figure	NF	f = 0.95 GHz	-	3.7	4.5	dB
		f = 2.15 GHz	-	3.7	4.5	
Upper Limit Operating Frequency	f <sub>u</sub>	3 dB down below flat gain at f = 0.95 GHz	-	2.8	-	GHz
Isolation	ISL	f = 0.95 GHz, P <sub>in</sub> = -35.0 dBm	36.0	41.0	-	dB
		f = 2.15 GHz, P <sub>in</sub> = -35.0 dBm	36.0	45.0	-	
Input Return Loss	RL <sub>in</sub>	f = 0.95 GHz, P <sub>in</sub> = -35.0 dBm	7.0	8.5	-	dB
		f = 2.15 GHz, P <sub>in</sub> = -35.0 dBm	8.0	11.0	-	
Output Return Loss	RL <sub>out</sub>	f = 0.95 GHz, P <sub>in</sub> = -35.0 dBm	7.0	10.5	-	dB
		f = 2.15 GHz, P <sub>in</sub> = -35.0 dBm	9.5	13.0	-	
Gain Flatness	ΔG <sub>P</sub>	f = 0.95 to 2.15 GHz	-	2.5	4.0	dB

**OTHER CHARACTERISTICS, FOR REFERENCE PURPOSES ONLY**

( $T_A = +25^\circ\text{C}$ ,  $V_{CC} = V_{out} = 5.0\text{ V}$ ,  $Z_S = Z_L = 50\ \Omega$ )

Parameter	Symbol	Test Conditions	Reference Value	Unit
Output intercept point	OIP <sub>3</sub>	f = 0.95 GHz	21.0	dBm
		f = 2.15 GHz	16.0	

**TEST CIRCUIT**

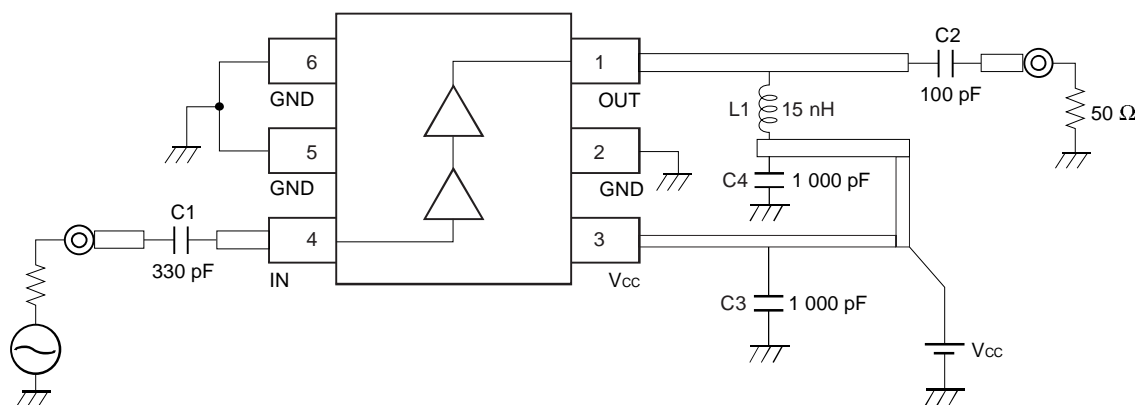

The application circuits and their parameters are for reference only and are not intended for use in actual design-ins.

**COMPONENTS OF TEST CIRCUIT FOR MEASURING ELECTRICAL CHARACTERISTICS**

	Value	Maker	Type code
C1	330 pF	Murata	GMR36CH
C2	100 pF	Murata	GMR36CH
C3	1 000 pF	Murata	GMR39CH
C4	1 000 pF	Murata	GMR36B
L1	15 nH	Susumu	TFL0816

**INDUCTOR FOR THE OUTPUT PIN**

The internal output transistor of this IC consumes 24.5 mA, to output medium power. To supply current for output transistor, connect an inductor between the Vcc pin (pin 3) and output pin (pin 1). Select inductance, as the value listed above.

The inductor has both DC and AC effects. In terms of DC, the inductor biases the output transistor with minimum voltage drop to output enable high level. In terms of AC, the inductor makes output-port impedance higher to get enough gain. In this case, large inductance and Q is suitable.

**CAPACITORS FOR THE Vcc, INPUT AND OUTPUT PINS**

Capacitors of 1 000 pF are recommendable as the bypass capacitor for the Vcc pin. Capacitors of 330 pF for the input pin and 100 pF for the output pin are recommendable as the coupling capacitors.

The bypass capacitor connected to the Vcc pin is used to minimize ground impedance of Vcc pin. So, stable bias can be supplied against Vcc fluctuation.

The coupling capacitors, connected to the input and output pins, are used to cut the DC and minimize RF serial impedance. Their capacitances are therefore selected as lower impedance against a 50 Ohm load. The capacitors thus perform as high pass filters, suppressing low frequencies to DC.

ILLUSTRATION OF THE TEST CIRCUIT ASSEMBLED ON EVALUATION BOARD

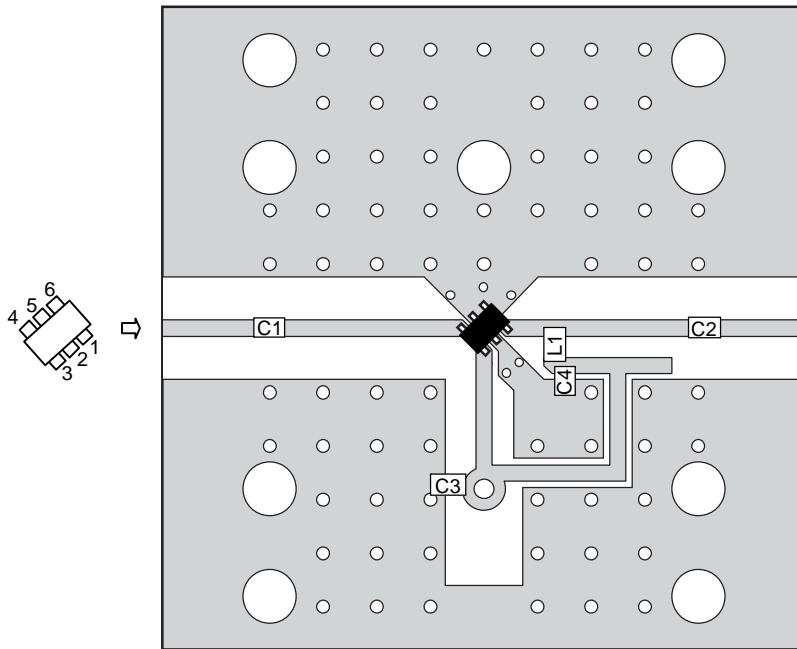

COMPONENT LIST

	Value
C1	330 pF
C2	100 pF
C3, C4	1 000 pF
L1	15 nH

Notes

1. 30 × 30 × 0.4 mm double sided copper clad polyimide board.
2. Back side: GND pattern
3. Solder plated on pattern
4. o○: Through holes

TYPICAL CHARACTERISTICS ( $V_{CC} = 5.0\text{ V}$ ,  $T_A = +25^\circ\text{C}$ , unless otherwise specified)

CIRCUIT CURRENT vs. SUPPLY VOLTAGE

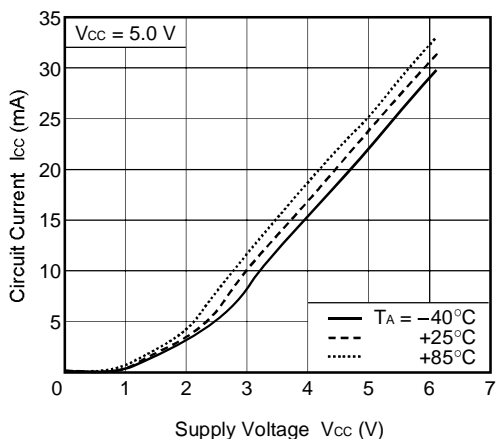

CIRCUIT CURRENT vs. OPERATING AMBIENT TEMPERATURE

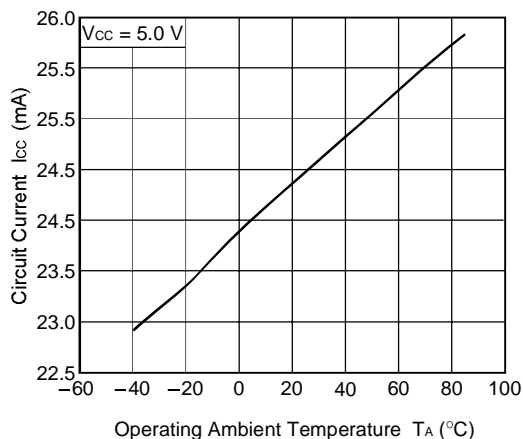

POWER GAIN vs. FREQUENCY

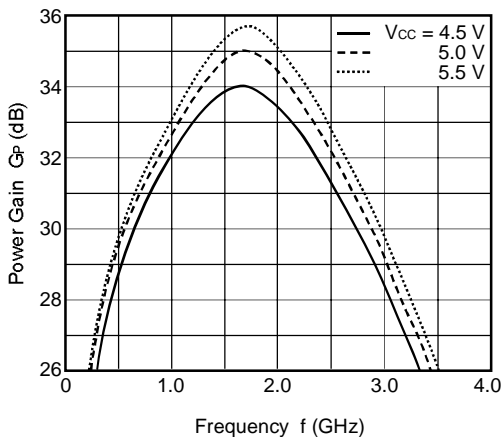

POWER GAIN vs. FREQUENCY

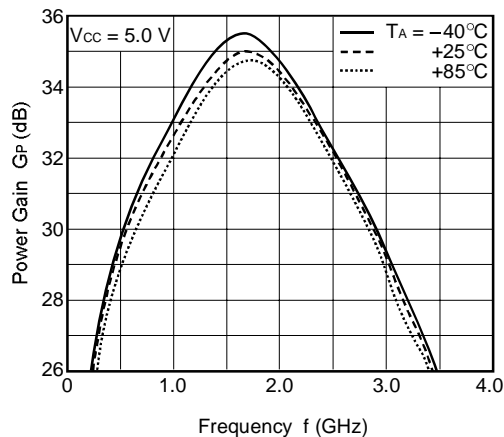

ISOLATION vs. FREQUENCY

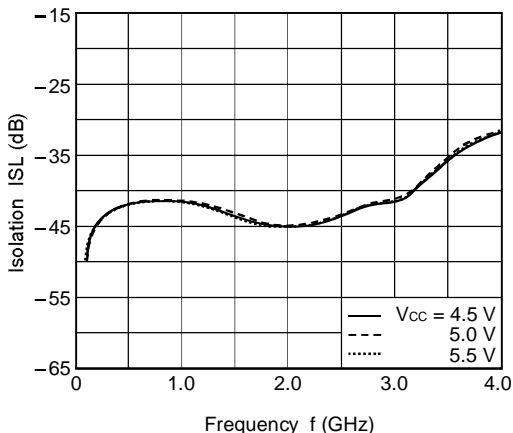

ISOLATION vs. FREQUENCY

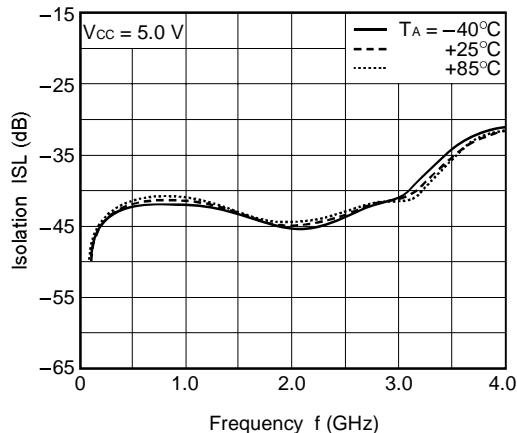

Remark The graphs indicate nominal characteristics.



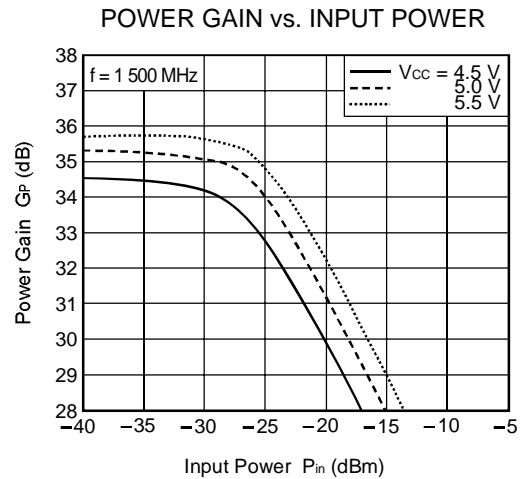
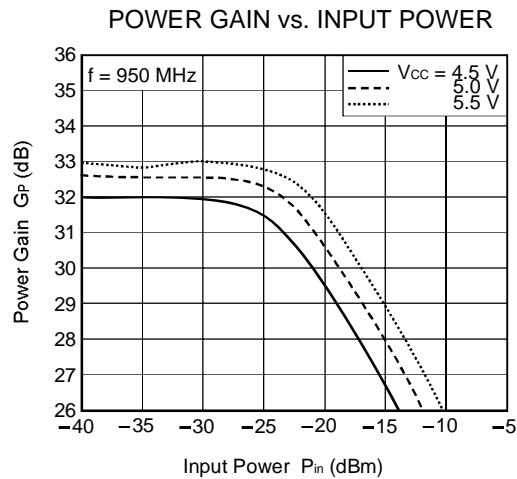
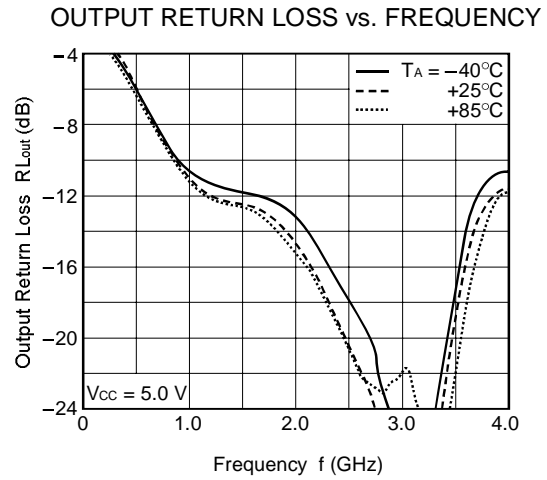
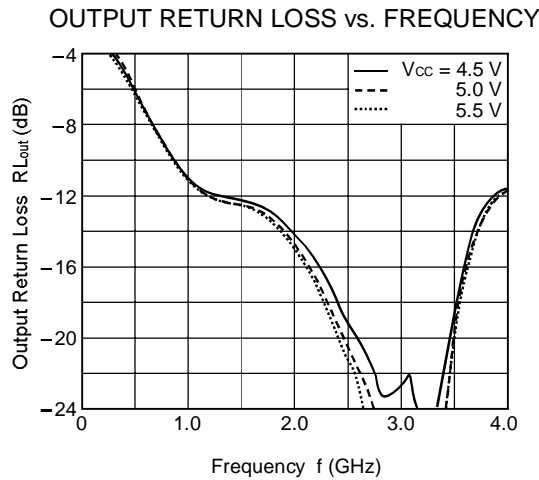
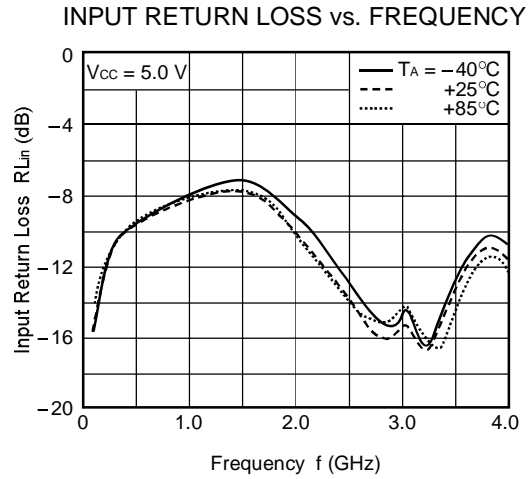
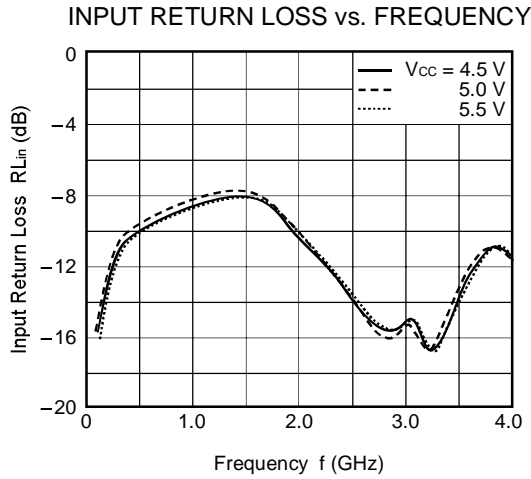

**Remark** The graphs indicate nominal characteristics.

POWER GAIN vs. FREQUENCY

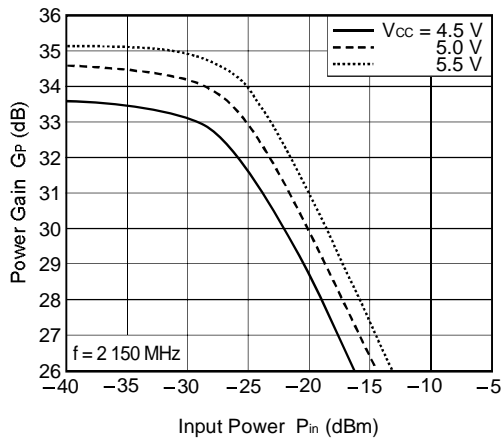

OUTPUT POWER vs. INPUT POWER

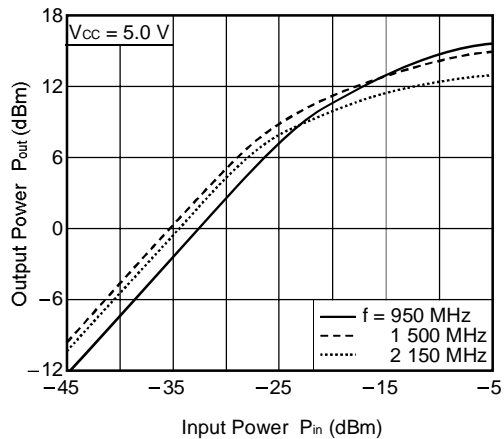

OUTPUT POWER vs. INPUT POWER

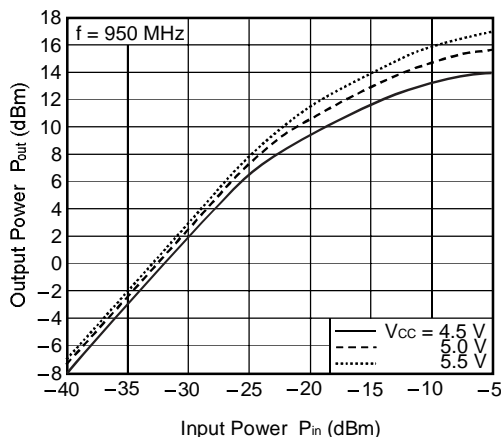

OUTPUT POWER vs. INPUT POWER

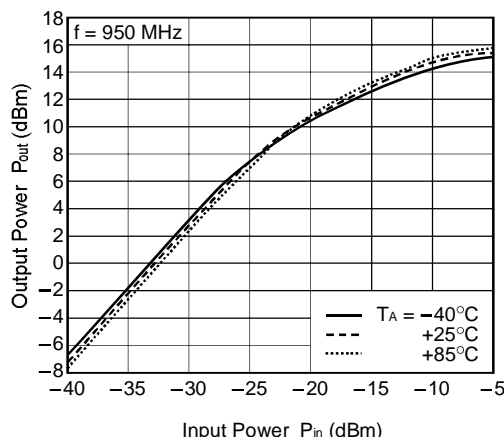

OUTPUT POWER vs. INPUT POWER

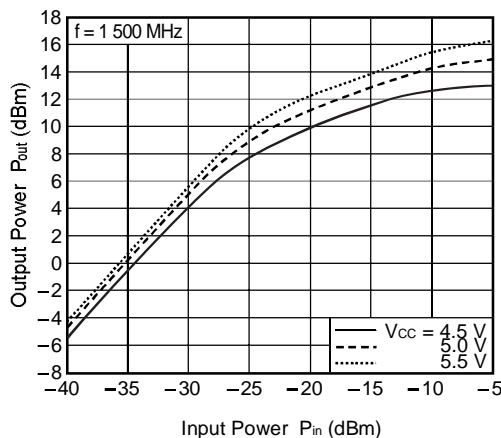

OUTPUT POWER vs. INPUT POWER

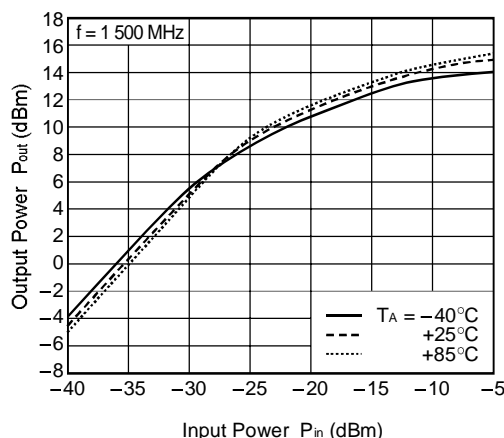

**Remark** The graphs indicate nominal characteristics.

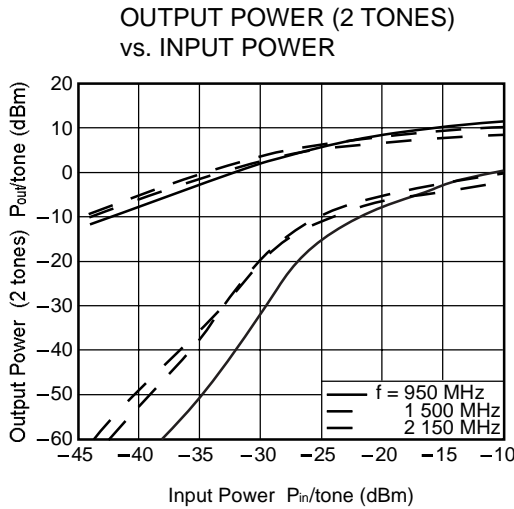
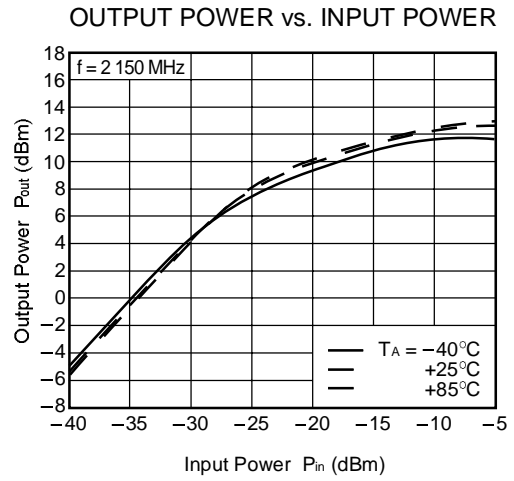
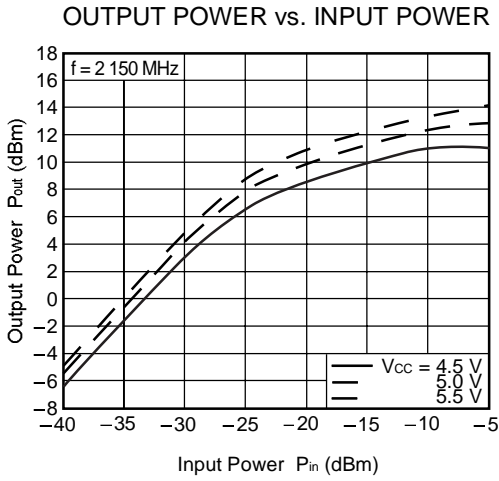

$V_{cc} = 5.0\ \text{V}, \Delta f = 1\ \text{MHz}$   
 $f = 950/951\ \text{MHz} : OIP_3 = 21.0\ \text{dBm}$   
 $f = 1\ 500/1\ 501\ \text{MHz} : OIP_3 = 18.2\ \text{dBm}$   
 $f = 2\ 150/2\ 151\ \text{MHz} : OIP_3 = 16.0\ \text{dBm}$

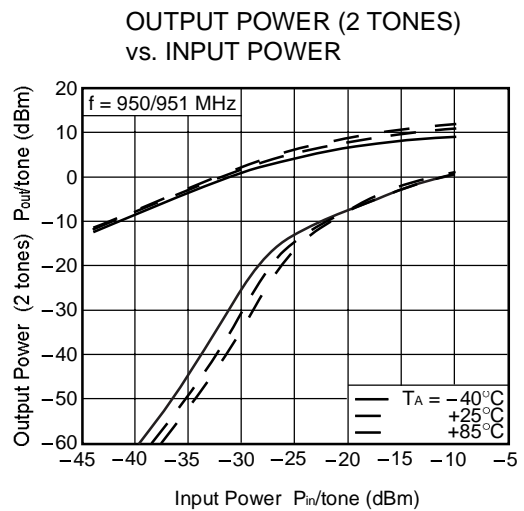
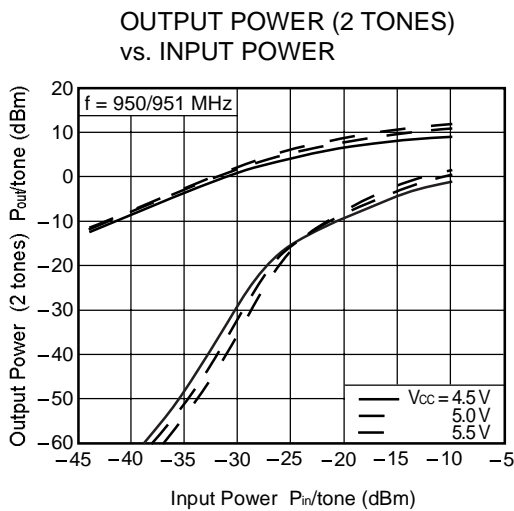

**Remark** The graphs indicate nominal characteristics.

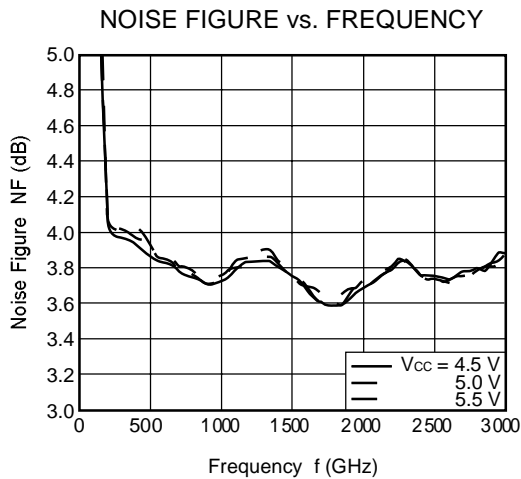
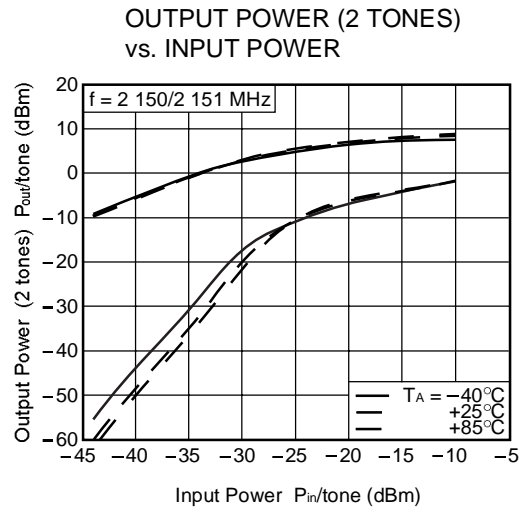
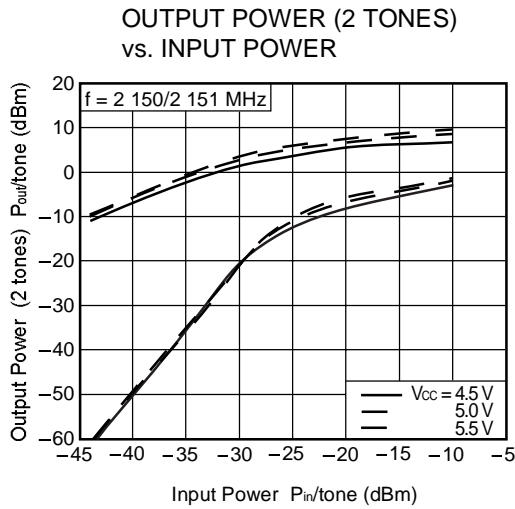
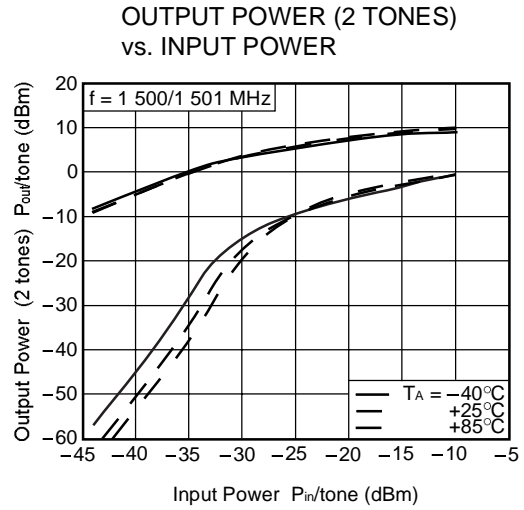
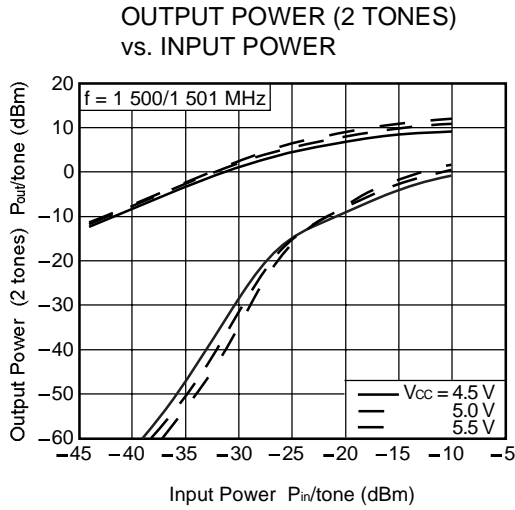

**Remark** The graphs indicate nominal characteristics.

S-PARAMETERS (T<sub>A</sub> = +25°C, V<sub>CC</sub> = V<sub>out</sub> = 5.0 V)

S<sub>11</sub>-FREQUENCY

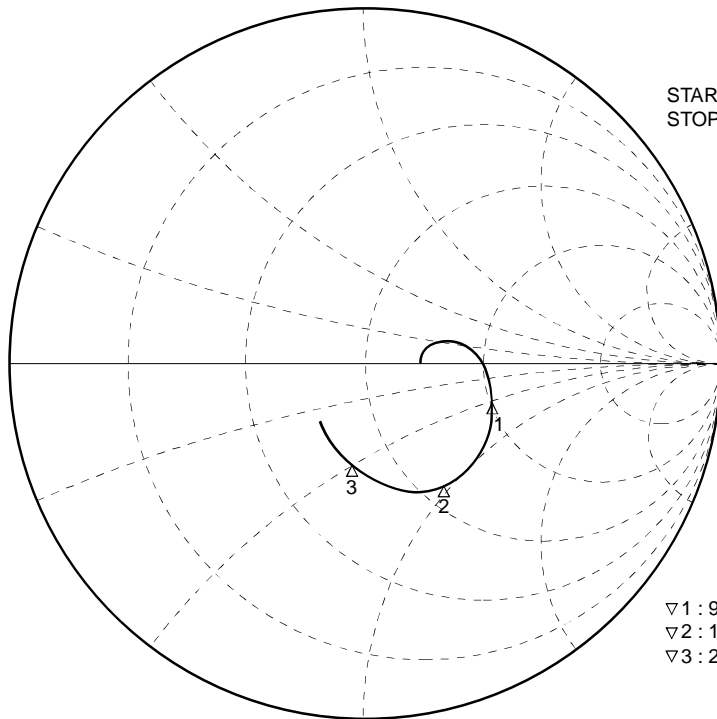

START : 100.000 000 MHz  
STOP : 3 000.000 000 MHz

▽1 : 950 MHz	100.41 Ω	-31.537 Ω	5.3124 pF
▽2 : 1 600 MHz	58.686 Ω	-47.725 Ω	2.0843 pF
▽3 : 2 150 MHz	39.938 Ω	-24.401 Ω	3.0338 pF

S<sub>22</sub>-FREQUENCY

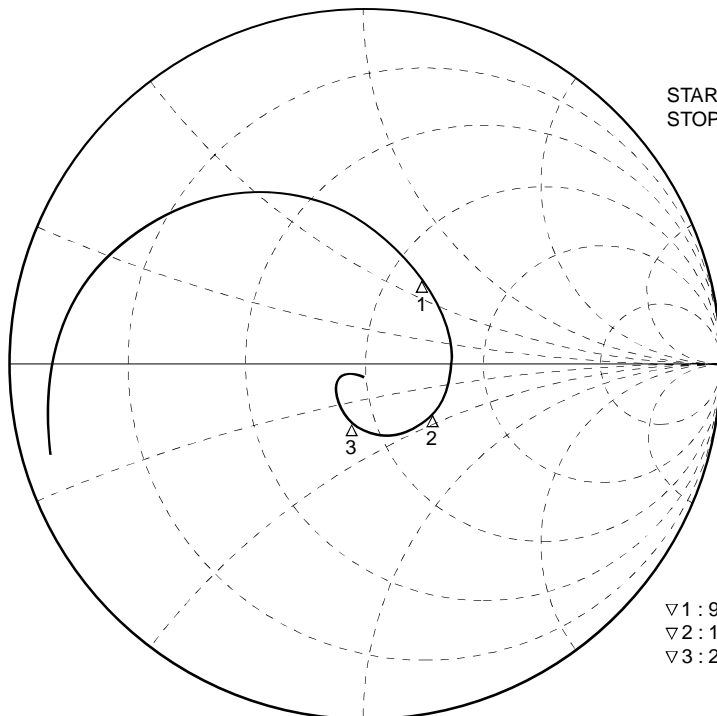

START : 100.000 000 MHz  
STOP : 3 000.000 000 MHz

▽1 : 950 MHz	60.637 Ω	32.730 Ω	5.4835 nH
▽2 : 1 600 MHz	70.195 Ω	-20.405 Ω	4.8754 pF
▽3 : 2 150 MHz	44.370 Ω	-14.407 Ω	5.1383 pF

**PACKAGE DIMENSIONS**

**6-PIN SUPER MINIMOLD (UNIT: mm)**

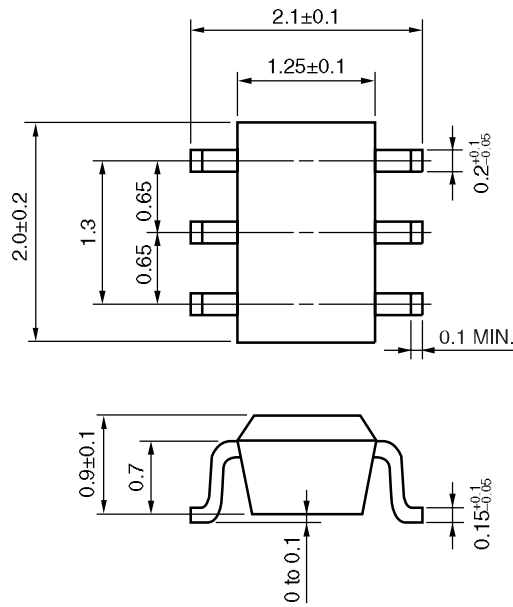

**NOTES ON CORRECT USE**

- (1) Observe precautions for handling because of electro-static sensitive devices.
- (2) Form a ground pattern as widely as possible to minimize ground impedance (to prevent undesired oscillation).  
All the ground pins must be connected together with wide ground pattern to decrease impedance difference.
- (3) The bypass capacitor should be attached to the Vcc pin.
- (4) The inductor (L) must be attached between Vcc and output pins. The inductance value should be determined in accordance with desired frequency.
- (5) The DC cut capacitor must be attached to input and output pin.

**RECOMMENDED SOLDERING CONDITIONS**

This product should be soldered and mounted under the following recommended conditions. For soldering methods and conditions other than those recommended below, contact your nearby sales office.

Soldering Method	Soldering Conditions	Condition Symbol
Infrared Reflow	Peak temperature (package surface temperature) : 260°C or below Time at peak temperature : 10 seconds or less Time at temperature of 220°C or higher : 60 seconds or less Preheating time at 120 to 180°C : 120±30 seconds Maximum number of reflow processes : 3 times Maximum chlorine content of rosin flux (% mass) : 0.2%(Wt.) or below	IR260
Wave Soldering	Peak temperature (molten solder temperature) : 260°C or below Time at peak temperature : 10 seconds or less Preheating temperature (package surface temperature) : 120°C or below Maximum number of flow processes : 1 time Maximum chlorine content of rosin flux (% mass) : 0.2%(Wt.) or below	WS260
Partial Heating	Peak temperature (terminal temperature) : 350°C or below Soldering time (per side of device) : 3 seconds or less Maximum chlorine content of rosin flux (% mass) : 0.2%(Wt.) or below	HS350

**Caution Do not use different soldering methods together (except for partial heating).**

Subject: Compliance with EU Directives

CEL certifies, to its knowledge, that semiconductor and laser products detailed below are compliant with the requirements of European Union (EU) Directive 2002/95/EC Restriction on Use of Hazardous Substances in electrical and electronic equipment (RoHS) and the requirements of EU Directive 2003/11/EC Restriction on Penta and Octa BDE.

CEL Pb-free products have the same base part number with a suffix added. The suffix –A indicates that the device is Pb-free. The –AZ suffix is used to designate devices containing Pb which are exempted from the requirement of RoHS directive (\*). In all cases the devices have Pb-free terminals. All devices with these suffixes meet the requirements of the RoHS directive.

This status is based on CEL’s understanding of the EU Directives and knowledge of the materials that go into its products as of the date of disclosure of this information.

Restricted Substance per RoHS	Concentration Limit per RoHS (values are not yet fixed)	Concentration contained in CEL devices	
		-A	-AZ
Lead (Pb)	< 1000 PPM	Not Detected	(*)
Mercury	< 1000 PPM	Not Detected	
Cadmium	< 100 PPM	Not Detected	
Hexavalent Chromium	< 1000 PPM	Not Detected	
PBB	< 1000 PPM	Not Detected	
PBDE	< 1000 PPM	Not Detected	

If you should have any additional questions regarding our devices and compliance to environmental standards, please do not hesitate to contact your local representative.

**Important Information and Disclaimer:** Information provided by CEL on its website or in other communications concerning the substance content of its products represents knowledge and belief as of the date that it is provided. CEL bases its knowledge and belief on information provided by third parties and makes no representation or warranty as to the accuracy of such information. Efforts are underway to better integrate information from third parties. CEL has taken and continues to take reasonable steps to provide representative and accurate information but may not have conducted destructive testing or chemical analysis on incoming materials and chemicals. CEL and CEL suppliers consider certain information to be proprietary, and thus CAS numbers and other limited information may not be available for release.

In no event shall CEL’s liability arising out of such information exceed the total purchase price of the CEL part(s) at issue sold by CEL to customer on an annual basis.

See CEL Terms and Conditions for additional clarification of warranties and liability.