

UTC UR3318 LINEAR INTEGRATED CIRCUIT

2 CHANNEL LOW-DROPOUT VOLTAGE REGULATOR

FEATURES

- *Dual Output: 3.3V/1A, 1.8V/1A.
- *Output Voltage Precision of $\pm 2\%$.
- *Output consists of PNP power transistor with low-dropout voltage.
- *Built-in over current protection circuit (OCP).
- *Built-in Thermal Shut Down Circuit (TSD).
- *Ideal for Hard Disk Drives applications.

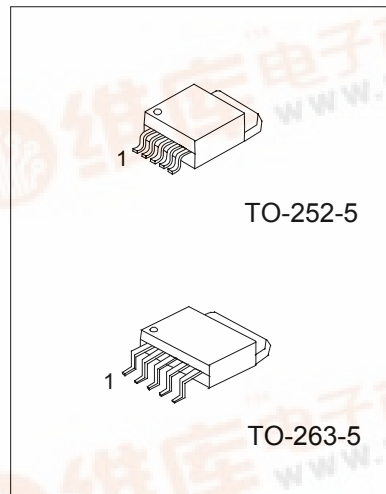

1: Vcc 2: NC 3: GND 4: Vo1 5: Vo2

*Pb-free plating product number: UR3318L

PIN DISCRIPTION

PIN NO.	PIN NAME	FUNCTION
1	Vcc	Power Supply
2	N.C.	Not internally connected
3	GND	Ground
4	Vo1	3.3V Output
5	Vo2	1.8V Output



UTCUR3318 LINEAR INTEGRATED CIRCUIT

BLOCK DIAGRAM

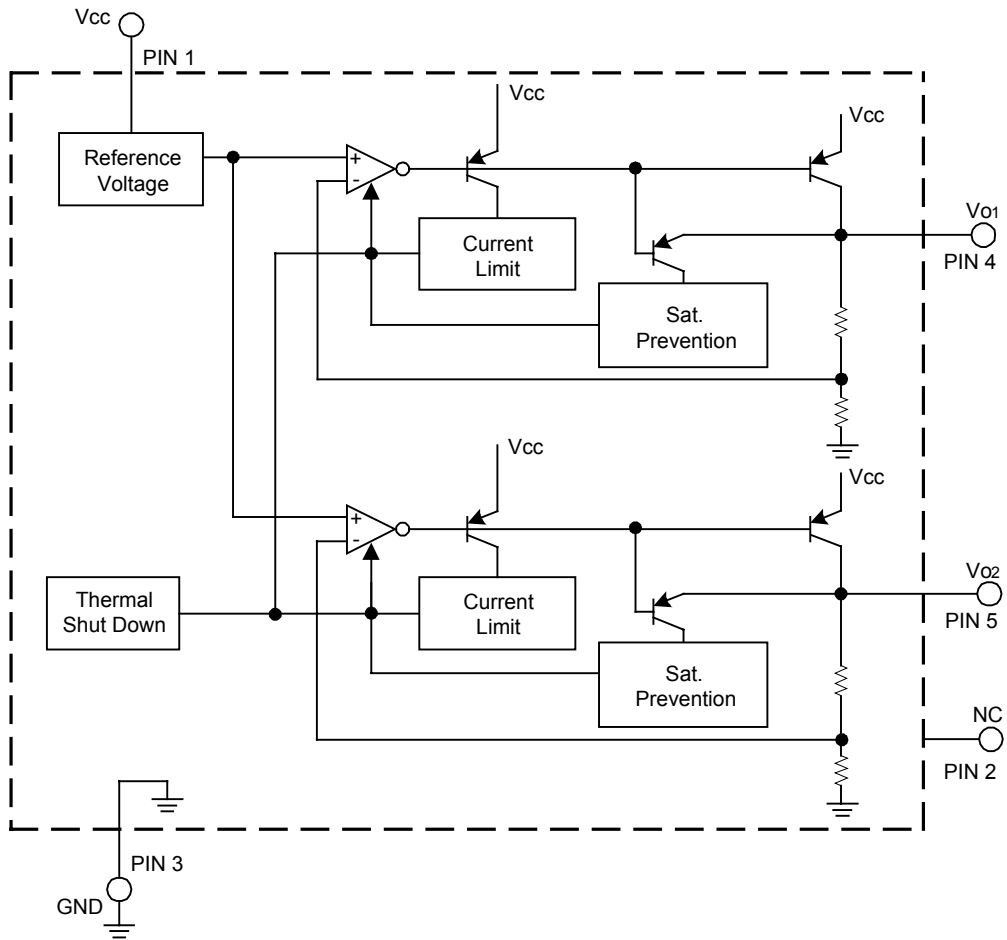

UTC UR3318 LINEAR INTEGRATED CIRCUIT

ABSOLUTE MAXIMUM RATINGS (T_a=25°C)

PARAMETER	SYMBOL	RATINGS	UNIT
Supply Voltage	V _{cc}	18	V
Power dissipation	P _D	1000*	mW
Operating temperature range	T _{opr}	-40 ~ +85	°C
Storage temperature range	T _{stg}	-55 ~ +150	°C
Junction temperature	T _j	150	°C

* P_D derated at 8mW/°C for temperatures above T_a=25°C

OPERATING RATINGS(T_a=25°C)

PARAMETER	SYMBOL	MIN	MAX	UNIT
Input Voltage	V _{cc}	3.0	16.0	V
3.3V Output current	I _{o1}		1	A
1.8V Output current	I _{o2}		1	A

ELECTRICAL CHARACTERISTICS

(Refer to the test circuit, T_a=25°C, V_{cc}=5V unless otherwise specified.)

PARAMETER	SYMBOL	TEST CONDITIONS	MIN	TYP	MAX	UNIT
Bias Current	I _B	I _{o1} =0mA, I _{o2} =0mA		0.8	1.5	mA
3.3V Output						
Output Voltage 1	V _{o1}	I _{o1} =500mA	3.234	3.30	3.366	V
Dropout Voltage 1	ΔV _{D1}	I _{o1} =500mA		0.25	0.5	V
Peak Output Current 1	I _{o1}		1.0	1.7		A
Ripple Rejection 1	R.R.1	f=120Hz, e _{in} =1Vrms I _{o1} =200mA	50	58		dB
Line Regulation 1	ΔV _{LINE1}	V _{cc} =4V ~ 16V, I _{o1} =500mA		5	30	mV
Load Regulation 1	ΔV _{LOAD1}	I _{o1} =0mA ~ 1A		30	75	mV
Temperature Coefficient of Output Voltage 1*	T _{CV01}	I _{o1} =5mA, T _J =0 ~ 125°C		±0.01		%/°C
Short circuit Output Current 1	I _{os1}	V _{cc} =16V		270		mA
1.8V Output						
Output Voltage 2	V _{o2}	I _{o2} =500mA	1.764	1.80	1.832	V
Peak Output Current 2	I _{o2}		1.0	1.7		A
Ripple Rejection 2	R.R.2	f=120Hz, e _{in} =1Vrms I _{o2} =200mA	50	58		dB
Line Regulation 2	ΔV _{LINE2}	V _{cc} =4V ~ 16V, I _{o2} =500mA		5	30	mV
Load Regulation 2	ΔV _{LOAD2}	I _{o2} =0mA ~ 1A		30	75	mV
Temperature Coefficient of Output Voltage 2*	T _{CV02}	I _{o2} =5mA, T _J =0 ~ 125°C		±0.01		%/°C
Short circuit Output Current 2	I _{os2}	V _{cc} =16V		270		mA

* Design Guarantee. (Outgoing inspection is not done on all products.)

○ This product is not designed for protection against radioactive rays.

Note: All characteristic are measured with a capacity across the input (0.33 μF) and the output (22 μF).

Measurement is done at T_A=T_J, and variations in the parameter of all measurement (except for Temperature Coefficient of Output Voltage)caused by temperature change are not considered.

UTCUR3318 LINEAR INTEGRATED CIRCUIT

POWER DISSIPATION

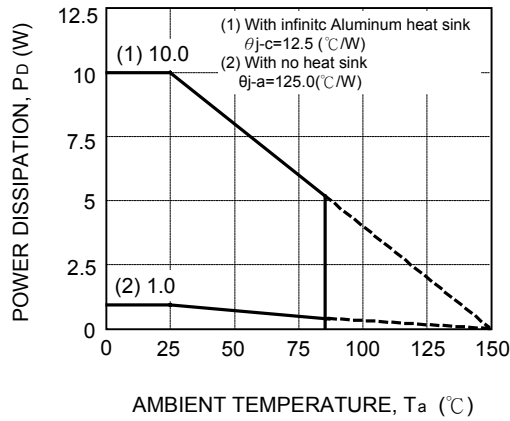

STANDARD APPLICATION CIRCUIT

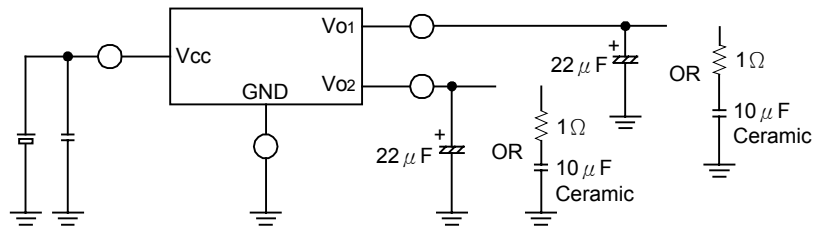

TEST CIRCUIT FOR EACH CONDITION

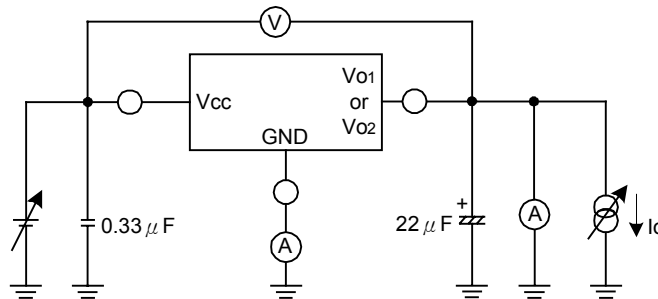

UTCUR3318 LINEAR INTEGRATED CIRCUIT

TEST CIRCUIT FOR RIPPLE REJECTION RATIO

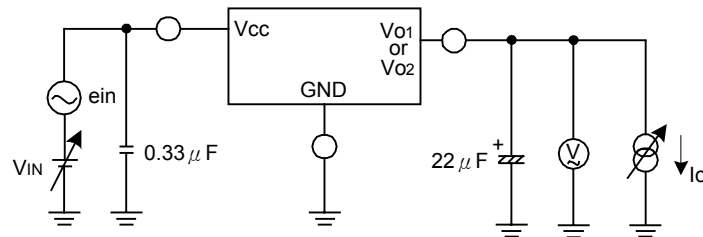

APPLICATION INFORMATION

Operation Supply Voltage Range

The circuit functionality is guaranteed within operation of ambient temperature range, as long as it is within operation supply voltage range. The standard electrical characteristic values are guaranteed at the test circuit voltage of $V_{cc}=5V$. The cannot be guaranteed at other voltages in the operating range of $3.0V\sim 16.0V$, however, the variation will be small.

- Input /Output characteristic

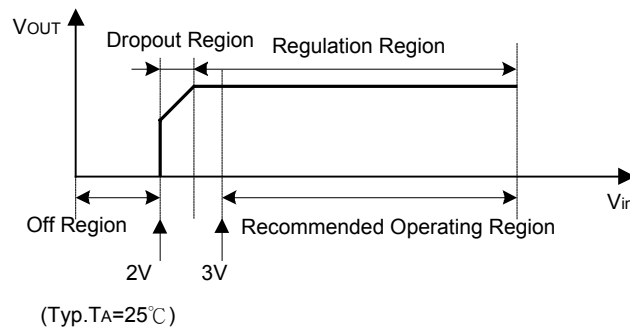

For proper regulation, this device must be operated in the Recommended Operating Region shown above.

Power Dissipation

Refer to the thermal duration characteristics shown in Fig.3. Also, be sure to use this IC within a power dissipation range allowing enough margins.

Output and Bypass Capacitor

To prevent oscillations, place the output capacitor between the output pin and GND for both channel. There is a possibility for oscillation if capacitor's value changes due to temperature, voltage, etc. More than $22\mu F$ electrolytic capacitor is recommended. If an extremely large value of (over $1000\mu F$) is used, it may cause oscillations at low frequency. In case of using ceramic capacitor (it is recommended more than $10\mu F$) connect with 1Ω resistance

UTC UR3318 LINEAR INTEGRATED CIRCUIT

serially as ESR. For the bypass capacitor, a 0.33 μ F capacitor placed as close to Vcc pin and GND pin as possible is recommended.

Over- current Protection Circuit

The over-current protection circuits are built in at the outputs. They protect the IC from being damaged when the load is short-circuited or subjected to an over current condition. This protection circuits perform holdback current limiting.

Thermal Protection Circuit

A thermal shut down circuit (T.S.D.) is built into the IC to prevent damage due to overheating, Therefore, all the outputs are turned off when the T.S.D. circuit is activated and are turned on when the temperature recedes to the specified level. However, the T.S.D. circuit is only for extreme conditions and the regulator circuit should still be designed for the IC not to exceed $T_J(\text{max})=150^\circ\text{C}$.

Grounding

It is recommended that every capacitor (bypass and output capacitors) is grounded to PIN3 using single-point connections.

Electromagnetic Fields

The IC is susceptible to strong electromagnetic fields and may cause malfunction. Therefore, caution should be used when placing it on the PCB.

Protection Diodes

It is recommended that protection diodes be used when the output is connected to an inductive load.

UTC assumes no responsibility for equipment failures that result from using products at values that exceed, even momentarily, rated values (such as maximum ratings, operating condition ranges, or other parameters) listed in products specifications of any and all UTC products described or contained herein. UTC products are not designed for use in life support appliances, devices or systems where malfunction of these products can be reasonably expected to result in personal injury. Reproduction in whole or in part is prohibited without the prior written consent of the copyright owner. The information presented in this document does not form part of any quotation or contract, is believed to be accurate and reliable and may be changed without notice.